

Operator Manual

For printer model:

CL4NX **Plus**

CL6NX **Plus**

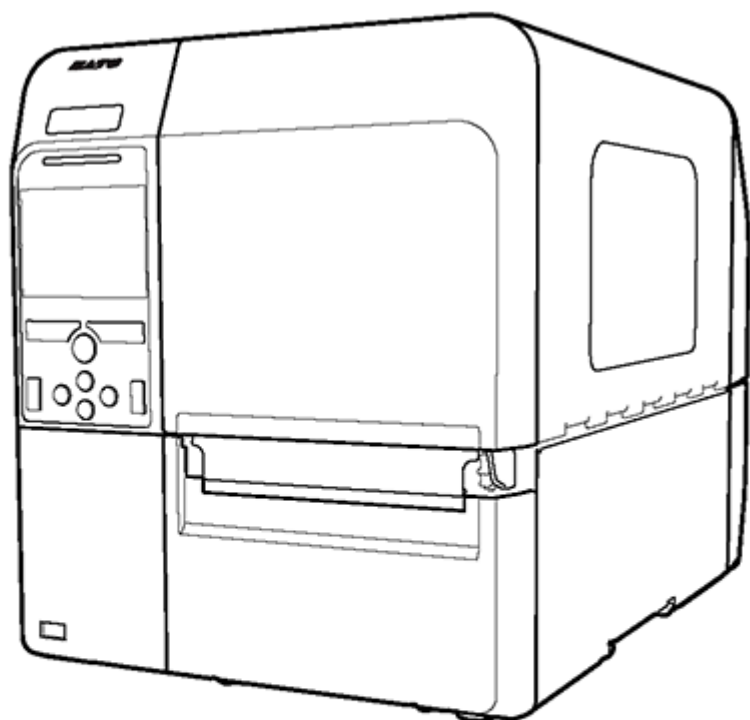

Table of Contents

Before You Start.....	8
About This Manual.....	8
Features of the Product.....	9
Safety Precautions.....	10
Precautions for Installation and Handling.....	15
Select a Safe Location.....	15
Power Supply.....	16
Printing.....	17
Regulatory Approval.....	18
Environmentally Hazardous Materials.....	21
Copyrights.....	22
Limitation of Liability.....	23
Trademarks.....	24
Basic Information.....	25
Bundled Accessories.....	25
Optional Devices.....	26
Parts Identification.....	28
Parts Identification for the Product.....	28
Front View.....	28
Rear View.....	29
Internal View.....	30
Parts Identification for the Operator Panel.....	31
Using the Operator Panel.....	33
Display and Operation of the Operator Panel.....	33
LED Indicator.....	33
Operations in Online/Offline Mode.....	33
Status Icon.....	35
Operations When Errors Occur.....	40
Guidance Videos.....	44
Adjusting the Print Settings During Printing.....	49
Canceling the Print Job.....	50
Settings Mode.....	52
Settings Mode Menus.....	52
Changing to the Settings Mode.....	52
Logging In to/Logging Out of the Settings Mode.....	54
Item Selection.....	54
Setting Value Input or Selection.....	56
Product Memory and USB Memory.....	61
Getting Started.....	62
Installation.....	62
Installation Precautions.....	62
Installation Space.....	64
Front View.....	64
Side View.....	65
Bottom View.....	66
Powering On/Off the Product.....	68

Connecting the Power Cord.....	68
Powering On the Product.....	70
Powering Off the Product.....	71
Initial Setup (Startup Guide).....	73
Overview of the Startup Guide.....	74
Startup Screen.....	78
Language Selection.....	79
Region Setting with Optional RTC Kit.....	80
City Setting with Optional RTC Kit.....	81
Date Setting with Optional RTC Kit.....	82
Time Setting with Optional RTC Kit.....	83
Print Method Setting.....	84
Ribbon Setting.....	85
Media Sensor Type Setting.....	86
Media Setting.....	87
Completion of Initial Setup Screen.....	89
Startup Guide Cancelation.....	90
Configuring the Product According to Media and Options.....	91
Print Method.....	92
Media Sensor Type.....	95
Print Mode.....	99
Connecting the Product to a Computer.....	103
Procedure for Connecting the Product to a Computer.....	104
Connecting Interfaces.....	105
Available Interfaces.....	105
USB Interface Connection (Standard).....	106
LAN Interface Connection (Standard).....	106
Bluetooth Interface Connection (Standard).....	107
NFC Interface Connection (Standard).....	107
RS-232C Interface Connection (Standard).....	108
IEEE1284 Interface Connection (Standard).....	109
Wireless LAN Interface Connection (Optional).....	110
Configuring the Interface Settings.....	112
Interface Setting Methods.....	112
Configuring the Interface Settings from the Interface Menu of the Product.....	112
Configuring the Interface Settings Using the All-In-One Tool.....	115
Installing the Printer Driver.....	116
All-In-One Tool Features.....	117
Loading Media and Ribbon.....	118
Media, Ribbon and Print Methods.....	118
Loading Media.....	119
Usable Media.....	119
Adjusting the Position of the Media Sensor.....	120
Loading the Media.....	121
Precautions for Loading the Media.....	121
Loading the Media Roll.....	121
Loading the Fan-fold Media.....	125
Loading the Media with the Optional Cutter Unit.....	126
Loading the Media with the Optional Rotary Cutter Unit (CL4NX Plus Only).....	132
Loading the Media with the Optional Dispenser Unit and Liner Discharge Outlet.....	137
Loading the Media with the Optional Dispenser Unit and Liner Discharge Rewinder.....	141
Removing the Liner from the Rewinder.....	146
Loading Ribbon (Thermal Transfer Only).....	147
Checking the Ink Side of the Ribbon.....	148
Loading the Ribbon.....	149
Replacing the Ribbon.....	153

When to Replace Media and Ribbon.....	157
Checking the Remaining Amount of Media and Ribbon.....	157
Conditions That Trigger Paper End.....	158
Conditions That Trigger Label Near End.....	161
Conditions That Trigger Ribbon End.....	162
Conditions That Trigger Ribbon Near End.....	163
Various Settings of the Product.....	164
The Product's [Settings] Menu.....	164
[Shortcut] Menu.....	164
[Printing] Menu.....	165
[Label Length].....	166
[Label Width].....	167
[Auto Measure].....	168
[Printing Mode].....	169
[Ribbon Near End].....	169
[Speed].....	170
[Sensor Type].....	171
[Micro Label Print Mode].....	172
[Auto-mode].....	176
[Print Mode].....	176
[Backfeed].....	178
[Eject Cut].....	179
[Darkness Range].....	179
[Darkness].....	180
[Imaging].....	180
[Advanced].....	184
[Interface] Menu.....	205
[Network].....	206
[IEEE1284].....	326
[RS-232C].....	328
[USB].....	332
[Bluetooth].....	334
[NFC].....	341
[Ignore CR/LF].....	342
[Ignore CAN/DLE].....	342
[External I/O].....	343
[RFID] (RFID Models Only).....	349
[Applications] Menu.....	378
[Protocol].....	379
[Auto Switch Group].....	380
[SBPL].....	384
[SZPL].....	397
[S IPL].....	403
[STCL].....	406
[SDPL].....	414
[SEPL].....	436
[AEP].....	441
[System] Menu.....	444
[Regional].....	445
[Notifications].....	451
[Sound].....	458
[Energy Saving].....	460
[LCD Brightness].....	461
[Show Total Count].....	461
[Password].....	462
[Start on AC].....	466
[Tools] Menu.....	467

[Test Print].....	468
[HEX-Dump].....	480
[Reset].....	488
[Profiles].....	492
[Certificates].....	495
[Barcode Checker].....	497
[Clone].....	509
[Support Info].....	510
[Logging Function].....	511
[Startup Guide].....	514
[Information] Menu.....	515
[Help].....	517
[Build Version].....	522
[Applications].....	523
[Installation Log].....	524
[Print Module].....	525
[FPGA Version].....	527
[Counters].....	527
[IPv4 Address].....	528
[IPv6 Address].....	529
[LAN MAC].....	529
[Wi-Fi MAC].....	530
[Wi-Fi Region].....	530
[Wi-Fi Status].....	531
[Wi-Fi Direct].....	531
[Wi-Fi Versions].....	532
[Wi-Fi Module].....	533
Configuring the Product Settings from a Web Browser.....	534
Accessing to the Web Configuration Page.....	534
Dashboard.....	536
Settings.....	538
Tools.....	540
Certificates.....	542

Various Ways to Output..... 543

Outputting with General-purpose Software.....	543
Outputting and Controlling with Dedicated Command.....	544
Controlling the Product with External Signal.....	545

Adjusting the Product..... 546

Printable Area.....	546
Media Sensor Positions and Media Stop Positions.....	548
Flow of Printing Operations.....	550
Printing Operations.....	550
Operations in Continuous Mode.....	551
Operations in Tear-Off Mode.....	555
Operations in Cutter Mode.....	561
Operations in Dispenser Mode.....	579
Operations in Linerless Mode (CL4NX Plus Only).....	597
Operations for RFID Write (RFID Models Only).....	603
Operations When the Barcode Check Function Is Enabled.....	618
Operations When the Media Sensor Is Disabled.....	623
Adjusting the Base Reference Point.....	624
About the Base Reference Point.....	624
Adjusting the Print Position.....	626
Adjusting the Media Stop Position.....	629

Notes on the Stop/Cut Position of Different Media.....	632
Adjusting the Print Quality.....	634
Adjusting the Print Darkness.....	634
Adjusting the Print Speed.....	637
Adjusting the Product's Buzzer Volume.....	640
Adjusting the Head Pressure Balance.....	642
Print Head Balance.....	642
Head Pressure Setting.....	643
Pressure Balance Setting.....	644
RFID Settings (RFID Models Only).....	646
Usable RFID Standards.....	646
Configuring the Product to Encode Inlays.....	647
Setting Write/Read Conditions Appropriate for RFID Tags.....	650
Using the SATO RF Analyze Function to Measure RFID Tags.....	650
Loading the Saved RFID Tag Model.....	657
Printing RFID Tag Errors.....	662
RFID Error and Reset Timing.....	669
External Signal (EXT) Interfaces When RFID Mode Is Enabled.....	672
RFID Printing Tips.....	674
Configuring Optional Barcode Check Function.....	675
Basic Specifications of the Barcode Check Function.....	675
Setting Up the Barcode Checker.....	682
Operational Settings for the Barcode Checker and Installation.....	682
Changing How the RS-232C Interface is Used (When Using the KEYENCE Barcode Checkers).....	683
Doing a Test Read with the Barcode Checker.....	685
Enabling the Barcode Check.....	689
Selecting the Barcode Check Mode.....	689
Contents of the Check for Readable Mode and Comparison Mode.....	691
Restrictions for the Barcode Check Function.....	694
Initializing the Product.....	697
Procedures for Initializing.....	697
Initializing the Data Saved on the Product.....	697
Initializing the Setting Values and Data on the Product.....	700
Initializing the Setting Values on the Product.....	704
List of Initial Values.....	709
[Printing] Menu.....	709
[Interface] Menu.....	712
[Applications] Menu.....	729
[System] Menu.....	734
[Tools] Menu.....	736
[Information] Menu.....	739
Maintenance.....	741
Cleaning the Product.....	741
Cleaning.....	741
Cleaning Intervals.....	742
Cleaning Using the Cleaning Kit.....	743
Cleaning the Optional Linerless Cutter Kit (CL4NX Plus Only).....	746
Cleaning Using the Cleaning Sheet.....	747
Replacing Consumable Parts.....	750
Replacing the Print Head.....	750
Replacing the Platen Roller.....	752
Operating the Notification Screen of SOS (SATO Online Services) (SOS users only).....	755
Operating the Notification Screen of the SOS (SATO Online Services) On-Demand Mode (SOS users only).....	755

Operating the Date and Time Settings Notification Screen of SOS (SATO Online Services) (SOS users only).....	757
SOS (SATO Online Services) Application (SOS users only).....	759
When You Are in Trouble.....	760
When an Error Message Appears.....	760
Error Message Indication and Operating Procedure When the SOS (SATO Online Services) Is Enabled (SOS users only).....	824
Contact Information for When You Are in Trouble.....	826
Product Specifications.....	827
Hardware.....	827
Interface.....	832
Supported Interfaces.....	832
USB Interface.....	833
LAN Interface.....	834
Bluetooth Interface.....	835
NFC Interface.....	836
RS-232C Interface.....	837
IEEE1284 Interface.....	839
External Signal (EXT) Interface.....	841
Basic Specifications of External Signal (EXT) Interface.....	841
Connector Pin Specifications of External Signal (EXT) Interface.....	841
Timing Chart of the EXT Input Signal.....	843
Timing Chart of the EXT Output Signal.....	845
Timing Chart of the Wait Signal for Dispense Completion.....	848
Wireless LAN Interface.....	850
Built-in Functions.....	852
Printer Languages.....	854
Standards.....	855
Usable Media.....	856
Usable Ribbon.....	860
Usable Fonts.....	861
Usable Barcodes.....	885
Support and Warranty.....	887
SOS (SATO Online Services) (SOS users only).....	887
Warranty for Consumables within the Product Warranty Period.....	888

Before You Start





About This Manual

Thank you for purchasing the SATO CL4NX Plus/CL6NX Plus (hereafter referred to as "the product").

This manual supplies basic information on how to operate the CL4NX Plus/CL6NX Plus. Read the manual carefully to understand each function of the CL4NX Plus/CL6NX Plus before operation.

Symbols

This operator manual uses following symbols:

Item	Description
 Warning	The Warning symbol indicates that you can cause death or serious injury if you do not follow the instructions or procedures.
 Caution	The Caution symbol indicates that you can cause injury or property damage if you do not follow the instructions or procedures.
 Note	The Note symbol indicates useful and supplemental information that you should know.
 Reference	The Reference symbol indicates the link of relevant information.



- Reproduction in any manner of all or part of this manual is prohibited.
- The content of this manual is subject to change without notice.
- Great care has been taken in the preparation of this document, but if any problems, mistakes, or omission are found, please contact your SATO reseller or technical support.



- The illustrations and screens in this manual are from CL4NX Plus, if there are no instructions.
 - This manual uses the build version 1.13.2-r1 firmware in its descriptions.
-

Features of the Product

CL4NX Plus/CL6NX Plus is a high-performance labeling printer with engineered with a robust die-cast metal and equipped with versatile features for ZERO downtime.

The main features of CL4NX Plus/CL6NX Plus are as follows:

- High accuracy and high quality printing, with resolutions of 203, 305 and 609 dpi (CL4NX Plus only)
- Printing speeds, up to 14ips for CL4NX Plus, 10ips for CL6NX Plus
- Supports large media rolls with outside diameter of 265 mm (10 inches) for CL4NX Plus, 220 mm (8.66 inches) for CL6NX Plus
- Supports ribbon length up to 600 meters (1968.5 feet)
- Designed for ease of use and serviceability
- Easily see the printer status or errors with the highly legible TFT color 3.5-inch LCD
- Easy to operate through Onboard Guidance Videos
- Print head and platen roller can be replaced without tools
- Supports 31 languages for display and 47 languages for printing scalable fonts
- Supports various communication interfaces
- Supports various advance protocols such as IPv6, SNMP, LPD, FTP and NTP
- Supports SATOs' original Application Enabled Printing (AEP) for flexible user orientated features, such as PC less printing and linking directly to PLC and much more
- Supports SATO Online Services, for preemptive action of issues before they occur so to minimize downtime
- Supports various options: Cutter, Rotary cutter (CL4NX Plus only), Label dispenser, Barcode checker, Linerless cutter (CL4NX Plus only)
- Certified by Wi-Fi alliance





Safety Precautions

This topic describes how to use the product safely.

Be sure to read the following information carefully before using the product.

Pictographic Symbols

This operator manual and the product labels use a variety of pictographic symbols. These symbols emphasize the safe and correct use of the product and to prevent injury to others and property damage. The explanation of the symbols is as follows. Be sure to understand these symbols well before you read the main text.

 Warning	Ignoring the instructions marked by this symbol and erroneously operating the product could result in death or serious injury.
 Caution	Ignoring the instructions marked by this symbol and erroneously operating the product could result in injury or property damage.

Example Pictographs



The  pictograph means "Caution is required".

















The  pictograph means "Should not be done".





The  pictograph means "Must be done".





Warning







 <p>Do not use the voltage other than specified</p>	<ul style="list-style-type: none"> Do not use the power supply voltage other than the one specified. Doing so could result in a fire or electric shock.
 <p>Do not use in hazardous locations</p>	<ul style="list-style-type: none"> The product is not explosion proof certified. Do not use in a potentially explosive environment or atmosphere. Doing so could result in a fire or explosion.
 <p>Do not set on an unstable area</p>	<ul style="list-style-type: none"> Do not set the product on an unstable area, such as a wobbly table or slanted area or on an area subject to strong vibration. The product could fall or topple over, possibly resulting in injury.
 <p>Do not place in high-temperature locations</p>	<ul style="list-style-type: none"> Do not place the product near heating equipment such as cooking appliances or a heater, or in high-temperature locations. Doing so could damage the product or result in a fire or electric shock.
 <p>When the product is dropped or breaks</p>	<ul style="list-style-type: none"> If the product is dropped or breaks, immediately power it off, unplug the power cord from the outlet, and contact your SATO reseller or technical support. Using the product in one of these conditions could result in a fire or electric shock.
 <p>Handling the power cord and other cables</p>	<ul style="list-style-type: none"> Do not damage, break, or alter the power cord and other cables. Also, do not place heavy objects on the power cord or other cables, apply heat to them, place them in high-temperature locations, or forcibly bend, twist, or pull them. Doing so could result in a fire or electric shock. Do not splash water on the power cord or other cables or get them wet. Doing so could result in damage or electric shock. If the power cord and other cables become damaged (core is exposed, wires broken, deformed, etc.), contact your SATO reseller or technical support. Using the power cord and other cables in this condition could result in a fire or electric shock. The dedicated power cord included in the package is to be used specifically for this product. Do not use it for other electronic products. Also, do not use the power cord of other products for this product. Doing so could result in a fire or electric shock.

 <p>Always ground the connections</p>	<ul style="list-style-type: none"> Always connect the product's ground wire to a ground. Not grounding the ground wire could result in electric shock.
 <p>Do not use the product when something is abnormal</p>	<ul style="list-style-type: none"> Do not use the product if any abnormality such as smoke or an unusual odor is detected. Doing so could result in a fire or electric shock. Immediately power off the product, unplug the power cord from the outlet, and contact your SATO reseller or technical support for repairs.
 <p>Do not place containers holding water or other liquid near the product</p>	<ul style="list-style-type: none"> Do not place flower vases, cups, or other containers holding liquids, such as water or chemicals, near the product. If water or chemicals get inside the product, immediately power it off, and contact your SATO reseller or technical support. Using the product in this condition could result in a fire or electric shock.
 <p>Do not drop the product in water</p>	<ul style="list-style-type: none"> Do not use the product near a container holding liquid. If the product is dropped into water, immediately power it off, and contact your SATO reseller or technical support. Using the product in this condition could result in a fire or electric shock.
 <p>Do not put objects inside the product</p>	<ul style="list-style-type: none"> Do not insert or drop any metal or flammable objects down the opening (cable port, etc.) of the product. If a foreign object gets inside the product, immediately power it off, unplug the power cord from the outlet, and contact your SATO reseller or technical support. Using the product in this condition could result in a fire or electric shock.
 <p>Connecting cables or optional devices</p>	<ul style="list-style-type: none"> When connecting a cable or optional device to the product, be sure to turn off each of the devices. If they are connected with the power on, an optional device could move unexpectedly, resulting in injury, electric shock, or damage. When installing a cable or optional device, be sure not to make a mistake in the orientation and steps to install. Otherwise, it could result in injury, fire, electric shock, or damage. Do not use cables other than the ones supplied with the product or recommended by us. Doing so could result in smoke, fire, electric shock, or damage.
 <p>Do not operate with wet hands</p>	<ul style="list-style-type: none"> Do not power on/power off the product or plug/unplug the power cord and other cables with wet hands. Doing so could result in electric shock or damage.
	<ul style="list-style-type: none"> Do not disassemble or modify the product. Doing so could result in a fire or electric shock. Ask your SATO reseller or technical support to conduct internal inspections, adjustments, and repairs.

<p>Do not disassemble the product</p>	
 <p>Using the cleaning fluid</p>	<ul style="list-style-type: none"> • Do not use cleaning fluids other than the ones supplied with the product or recommended by us. • The cleaning fluid is to be strictly kept away from the fire. Never apply heat or place it in the fire. • Keep the fluid out of reach of children to prevent them from accidentally drinking it. If a child accidentally drinks the fluid, immediately consult with a physician.
 <p>Do not touch or insert any object in the cutter</p>	<ul style="list-style-type: none"> • Do not touch the cutter with your hands or insert foreign objects other than media into the cutter. Doing so could result in injury.

Caution

 <p>Carrying the product</p>	<ul style="list-style-type: none"> • Do not carry the product while loaded with media or attached to an optional external device. They could fall, possibly resulting in injury. • When setting the product on the floor or a stand, make sure not to get your fingers or hands trapped under the product. • Before moving the product, be sure to power it off, unplug the power cord from the outlet, and disconnect any connected cables. Moving the product with the power cord or cables still connected could damage them, possibly resulting in a fire, electric shock, or damage.
 <p>Do not place the product in areas with high humidity</p>	<ul style="list-style-type: none"> • Do not place this product in an area with high humidity or where condensation occurs. If condensation has occurred, immediately power off the product, and avoid using it until it is dried. Using the product while condensation is on it could result in a fire, electric shock, or damage.
 <p>Power cord and other cables</p>	<ul style="list-style-type: none"> • Grab a power cord and other cables by the plug when removing from the outlet or connector port. Removing a power cord and other cables by grabbing the cord/cable area could result in exposure of wires, breakage, fire, electric shock, or damage. • Do not place the power cord and other cables near a heater or other sources of heat. Doing so could result in melting of the power cord and other cables sheathing, fire, electric shock, or damage.
 <p>Loading fan-fold media</p>	<ul style="list-style-type: none"> • Be careful not to get injured when handling the media inlet or the cover.

 <p>Loading media roll</p>	<ul style="list-style-type: none"> • When loading a media roll, be careful not to get your fingers trapped between the media roll and the supply spindle.
 <p>Print head</p>	<ul style="list-style-type: none"> • The print head is hot after printing. Be careful not to get burned when replacing media or cleaning immediately after printing. • Do not touch the print head with your bare hands. Doing so could result in injury or damage. • To replace the print head, follow the procedure in the Operator Manual. If the Operator Manual does not contain this procedure, avoid trying to replace it on your own terms, and contact your SATO reseller or technical support. • When opening and closing the print head, make sure that objects other than media do not get caught. Otherwise, it could result in injury or damage.
 <p>Cover</p>	<ul style="list-style-type: none"> • When opening and closing the cover, be careful not to get your fingers trapped in between. Also, firmly hold the cover to prevent it from closing unexpectedly.
 <p>Always keep the cover of the product closed</p>	<ul style="list-style-type: none"> • Always have the cover of the product closed when using. You could get injured by touching the moving parts. Also, dust or foreign objects could get inside, possibly resulting in the product to malfunction.
 <p>When not using the product for a long time</p>	<ul style="list-style-type: none"> • When not using the product for a long time, unplug the power cord from the outlet to maintain safety.
 <p>During maintenance and cleaning</p>	<ul style="list-style-type: none"> • When maintaining and cleaning the product, unplug the power cord from the outlet to maintain safety.

Precautions for Installation and Handling

Select a Safe Location

Product operations can be affected by the product's environment.

Refer to the following instructions regarding how to install and handle the product.

Install the product on a surface that is flat and level.

Installing the product on a surface that is tilted, and not flat, may reduce the print quality. This may also cause malfunctions and decrease the life span of the product.

Do not install the product in a location that vibrates.

Subjecting the product to extreme physical shock or vibration may cause malfunctions or damage the product or lead to the product breakdown.

Do not use or store the product in a location where the temperature and/or humidity are high.

Avoid locations subject to extreme or fast changes in temperature or humidity.

Do not place the product near heating equipment such as a cooking appliance or heater, or in other high-temperature locations.

The product may break.

Do not use or store the product in a location exposed to water or oil.

Water or oil entering inside the product may cause a fire, electric shock or malfunction.

Avoid dust.

Dust build up may result in reduced print quality, malfunctions, or damage.

Keep out of direct sunlight.

The product has a built-in optical sensor. Exposure to direct sunlight may cause false detections by the sensor, and may cause the product to not operate correctly. In addition, close the cover when using the product.

Do not use in hazardous locations.

Do not use in a potentially explosive environment or atmosphere. Doing so could cause a fire or explosion.

Do not supply power from an AC outlet near electrical equipment with high power consumption.

Doing so could cause malfunctions or damage due to electrical noise or voltage reduction.

Power Supply

Product operations can be affected by the product's environment.

Refer to the following instructions regarding how to install and handle the product.

The product requires an AC power supply.

Be sure to connect the product to an AC power supply.

Connect the power cord to a grounded AC outlet.

Make sure that the product is connected to a grounded AC outlet.

Supply a stable source of electricity to the product.

Do not share its power outlet with other electrical devices. This could cause power fluctuations and performance issues with your product.

Printing

The print result varies depending on the usage environment (temperature and humidity), the supply condition, and the product settings (the print speed, the print darkness, etc.).

Please sufficiently test the product in your usage environment, and use it with the optimal combination.

If anything is unclear, or if you have any questions, contact your SATO sales representative or reseller.

Regulatory Approval



- When you want to take the product to countries other than where you purchased it, contact your SATO reseller.
-

FCC Warning

You are cautioned that changes or modifications not expressly approved by the party responsible for compliance could void your authority to operate the equipment.

This device complies with Part 15 of the FCC Rules. Operation is subject to the following two conditions: (1) this device may not cause harmful interference, and (2) this device must accept any interference received, including interference that may cause undesired operation.

This equipment has been tested and found to comply with the limits for a Class B digital device, pursuant to Part 15 of the FCC Rules. These limits are designed to provide reasonable protection against harmful interference in a residential installation. This equipment generates, uses and can radiate radio frequency energy and, if not installed and used in accordance with the instructions, may cause harmful interference to radio communications.

However, there is no guarantee that interference will not occur in a particular installation.

If this equipment does cause harmful interference to radio or television reception, which can be determined by turning the equipment off and on, the user is encouraged to try to correct the interference by one or more of the following measures:

- Reorient or relocate the receiving antenna.
- Increase the separation between the equipment and the receiver.
- Connect the equipment into an outlet on a circuit different from that to which the receiver is connected.
- Consult the dealer or an experienced radio/TV technician for help.

Shielded cable must be used in order to comply with the emission limits.

FCC Statement for Optional Wireless LAN

This device complies with RF radiation exposure limits set forth for an uncontrolled environment.

The antenna used for this transmitter must be installed to provide a separation distance of at least 20 cm from all people and must not be collocated or operating in conjunction with any other antenna or transmitter.

Bluetooth/Wireless Communication

Compliance Statement

This product has been certified for compliance with the relevant radio interference regulations of your country or region. To make sure continued compliance, do not:

- Disassemble or modify this product.
- Remove the certificate label (serial number seal) affixed to this product.

Use of this product near microwave and/or other wireless LAN equipment, or where static electricity or radio interference is present, may shorten the communication distance, or even disable communication.

Industry Canada (IC) Statement for Bluetooth

This device complies with Industry Canada license-exempt RSS standard(s). Operation is subject to the following two conditions:

- This device may not cause interference.

- This device must accept any interference, including interference that may cause undesired operation of the device.

This equipment complies with IC radiation exposure limits set forth for an uncontrolled environment and meets RSS-102 of the IC radio frequency (RF) Exposure rules. This equipment should be installed and operated keeping the radiator at least 20 cm or more away from person's body (excluding extremities: hands, wrists, feet and ankles).

Le présent appareil est conforme aux CNR d'Industrie Canada applicables aux appareils radio exempts de licence. L'exploitation est autorisée aux deux conditions suivantes :

- L'appareil ne doit pas produire de brouillage.
- L'utilisateur de l'appareil doit accepter tout brouillage radioélectrique subi, même si le brouillage est susceptible d'en compromettre le fonctionnement.

Cet équipement est conforme aux limites d'exposition aux rayonnements énoncées pour un environnement non contrôlé et respecte les règles d'exposition aux fréquences radioélectriques (RF) CNR-102 de l'IC. Cet équipement doit être installé et utilisé en gardant une distance de 20 cm ou plus entre le dispositif rayonnant et le corps (à l'exception des extrémités : mains, poignets, pieds et chevilles).

Disposal of Old Electrical & Electronic Equipment (Applicable in the European Union and other European countries with separate collection systems)



A product marked with this symbol on itself or on its packaging shall not be treated as household waste. Instead it shall be handed over to an appropriate collection point for the recycling of electrical and electronic equipment in accordance with local regulations. Inappropriate waste handling of this product may cause detrimental consequences for the environment and damage to human health. The recycling of materials will help to conserve natural resources and contribute to your community. For more detailed information on recycling of this product, please contact your local municipal organization, your household waste disposal service or the dealer where you purchased the product.

机器名称:条码打印机

部件名称	有毒有害物质或元素					
	铅 (Pb)	汞 (Hg)	镉 (Cd)	六价铬 (Cr6+)	多溴联苯 (PBB)	多溴二苯醚 (PBDE)
印刷电路板	×	○	○	○	○	○
电源, 交流转换器 器电池	×	○	○	○	○	○
热敏头, 液晶显示 屏	×	○	○	○	○	○
电动机, 切纸机	×	○	○	○	○	○
树脂 (ABS, PC 等)	○	○	○	○	○	○
金属 (铁, 非铁 金属)	×	○	○	○	○	○
电缆等	×	○	○	○	○	×
包装材料 (纸盒 等)	○	○	○	○	○	○

本表格依据SJ/T 11364的规定编制。

- :表示该有毒有害物质在该部件所有均质材料中的含量均在GB/T 26572“电子信息产品中有毒有害物质的限量要求”的标准规定以下。
- ×:表示该有毒有害物质至少在该部件的某一均质材料中的含量超出GB/T 26572“电子信息产品中有毒有害物质的限量要求”的标准规定。

<p>环保使用期限</p>	<p>本标志中的年数,是根据2006年2月28日公布的“电子信息产品污染防治管理办法”和SJ/T11364“产品污染防治标识要求”,适用于在中华人民共和国(除台湾、香港和澳门外)生产或进口的电子信息产品的“环保使用期限”。在遵守使用说明书记载的有关本产品安全和使用上的注意事项,且没有其他法律和规定的免责事由的情况下,在从生产日开始的上述年限内,产品的有毒、有害物质或元素不会发生外泄或突变,使用该产品不会对环境造成严重污染或对使用者人身、财产造成严重损害。</p> <p>注1):“环保使用期限”不是安全使用期限。尤其不同于基于电气性能安全、电磁安全等因素而被限定的使用期限。产品在经适当使用后予以废弃时,希望依照有关电子信息产品的回收和再利用的法律与规定进行处理。</p> <p>注2):本标志中的年数为“环保使用期限”,不是产品的质量保证期限。对于同一包装内包含电池、充电器等附属品的产品,产品和附属品的环保使用期限可能不同。</p>
----------------------	--

Environmentally Hazardous Materials

RoHS Directive

This product is in conformity with RoHS Directive 2011/65/EU on the Restriction of the Use of Certain Hazardous Substances in Electrical and Electronic Equipment.

Compliance Status of REACH Regulation

(1) Status of registered chemical substances

No chemical substances are intentionally emitted, nor are there any chemical substances that are registered with the European Chemicals Agency.

(2) Information about the Substances of Very High Concern (SVHC) contained in the product

Currently, there has been no information communicated regarding SVHC that exceed 0.1% of the product's weight. In the future, if SVHC that exceed 0.1% of the product's weight are found, we will immediately communicate that information.

Copyrights

Any unauthorized reproduction of the contents of this document, in part or whole, is strictly prohibited.

© 2021 SATO Corporation. All rights reserved.

Limitation of Liability

- SATO Corporation and its subsidiaries in Japan, the U.S. and other countries make no representations or warranties of any kind regarding this material, including, but not limited to, implied warranties of merchantability and fitness for a particular purpose. SATO Corporation shall not be held responsible for errors contained herein or any omissions from this material or for any damages, whether direct, indirect, incidental or consequential, in connection with the furnishing, distribution, performance or use of this material.
- Specifications and contents in this document are subject to change without notice.
- Be sure to perform a virus check on the USB memory before connecting it to the product. SATO Corporation shall not be held responsible for any product malfunctions caused by a virus spread via USB memory.

Trademarks

- The following are registered trademarks of SATO Holdings Corporation and its subsidiaries in Japan, the U.S. and other countries.
 - SATO
 - Stylized SOS (SATO Online Services)

- NiceLabel[®] is a trademark or registered trademark of Euro Plus d.o.o.
- QR Code is a registered trademark of DENSO WAVE INCORPORATED.
- Wi-Fi[®] is a registered trademark of Wi-Fi Alliance.
- The following are trademarks of Wi-Fi Alliance.
 - Wi-Fi Direct[™]
 - Wi-Fi Protected Setup[™]
 - WPA[™]
 - WPA2[™]

- Windows and Internet Explorer are registered trademarks of Microsoft Corporation in the United States.
- Bluetooth is a trademark of Bluetooth SIG, Inc., U.S.A.
- ICODE, I-CODE, and SLI are registered trademarks of NXP B.V.
- MIFARE[®] is a registered trademark of NXP B.V.
- Tag-it[™] is a trademark of Texas Instruments.
- my-d[™] is a registered trademark of Infineon Technologies AG.
- FeliCa is a registered trademark of Sony Corporation.
- FeliCa is a contactless IC card technology developed by Sony Corporation.
- Android, YouTube, the YouTube logo, and Google Chrome are trademarks of Google LLC.
- The following are registered trademarks of Apple Inc., registered in the U.S. and other countries.
 - iPad
 - iPhone

- IOS is a trademark or registered trademark of Cisco in the U.S. and other countries and is used under license.
- Atheros is a registered trademark of Qualcomm Atheros, Inc.
- All other trademarks are the property of their respective owners.

Basic Information

Bundled Accessories

After unpacking the product, make sure that you have all the bundled accessories. If there are any missing items, contact the SATO reseller where you purchased the product.

- User documents (Quick Guide, Safety Instructions, and Global Warranty Program leaflet)

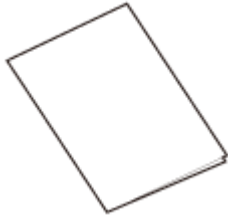

- Power cord

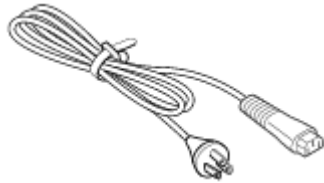

The shape of power plug varies depending on the region in which it was purchased.



- Keep the packaging box and cushioning material after installing the product. You can pack the product with this packaging box for shipment when requesting for repairs.
-

Optional Devices

The optional devices for the product are as follows. The optional devices can be factory installed or installed by the customer engineer. Contact your SATO reseller or technical support center.

Optional Devices	Description	Supported Models	
		CL4NX Plus	CL6NX Plus
Cutter unit	Automatically cuts the media in the designated number of pages.	Available	Available
Rotary cutter kit	Cuts tough materials with the heavy duty cutter.	Available	-
Simple dispenser kit	Removes the label from the liner. The liner is ejected out of the product.	Available	Available
Dispenser unit (with internal liner rewinder)	Removes the label from the liner. The liner can be ejected out of the product or rewound inside of the product.	Available	Available
Linerless cutter kit	The environmentally friendly linerless labels can be used.	Available	-
RTC (Calendar) kit	A calendar system for printing the date and time on a label to output.	Available	Available
External rewinder	Automatically rewinds the label output by the product.	Available RWG500	Available RWG500 (6-inch extension kit)
UHF RFID kit (ISO/IEC 18000-6 Type C Gen2)	Supports UHF RFID. It can read and write to the RFID tag.	Available	Available
HF RFID kit (ISO/IEC15693, ISO/IEC 14443 TypeA, FeliCa Lite-S)	Supports HF RFID. It can read and write to the RFID tag.	Available	-
W-LAN2: WLAN 802.11a/b/g/n/ac Dual Band WLAN (2.4GHz, 5GHz)	Communicates with the wireless LAN.	Available	Available
W-LAN:	Communicates with the wireless LAN.	Available	Available

Optional Devices	Description	Supported Models	
		CL4NX Plus	CL6NX Plus
WLAN 802.11a/b/g/n Dual Band WLAN (2.4GHz, 5GHz)			
Barcode checker stand kit	A stand kit to mount the barcode checker. For details of the installation, refer to the bundled Installation Manual.	Available	Available
External cover kit	A set of covers to prevent dust from entering the external openings for label supply. For details of the installation, refer to the bundled Installation Manual.	Available	Available



- The RFID kit and the rotary cutter kit cannot be used at the same time.
 - For more details about the optional devices, contact your SATO sales representative.
-

Parts Identification

Parts Identification for the Product

Front View

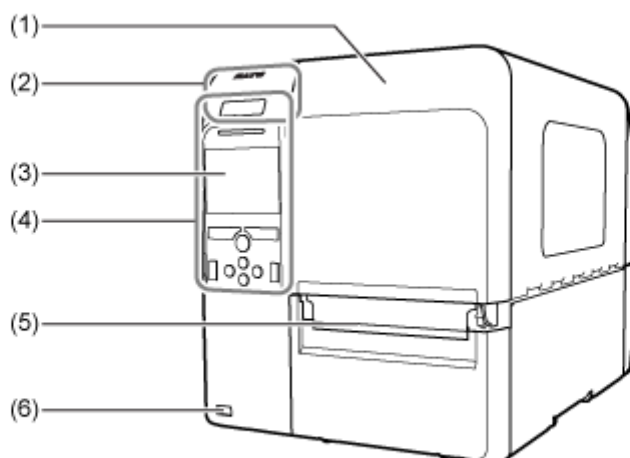

- (1) **Top cover**
- (2) **NFC antenna location**
- (3) **Color LCD**
- (4) **Operator panel**
- (5) **Media discharge outlet**
- (6) **USB connector (Type A)**

Enable the storage of product settings information with USB memory.

Also, other devices like a barcode checker, barcode scanner or keyboard can be connected.



- Be sure to perform a virus check on the USB memory before connecting it to the product. SATO Corporation shall not be held responsible for any product malfunctions caused by a virus spread via USB memory.
-

Rear View

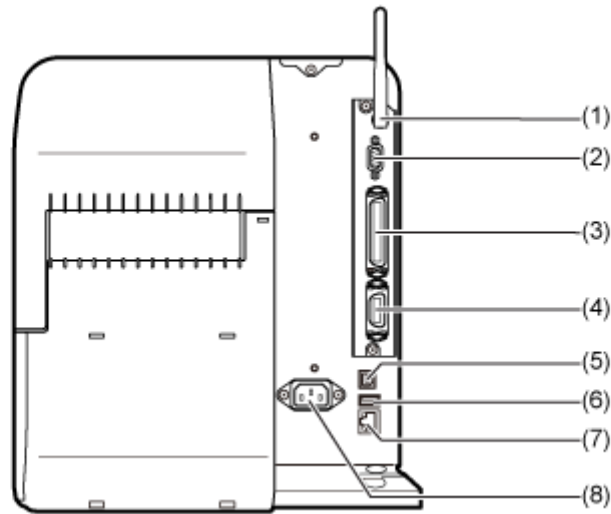

(1) Wireless LAN antenna (Optional)

Connector for installation of optional wireless LAN antenna.

(2) RS-232C connector

To connect the product to the computer using the RS-232C serial interface.

You can also connect a barcode checker.

Usage of the RS-232C interface can be selected in the [Tools] > [Barcode Checker] > [Test] > [Interface] menu.

(3) IEEE1284 connector

To connect the product to the computer using the IEEE1284 interface.

(4) EXT connector (External signal interface)

Interface connector for external signals. Connect an optional device to this terminal.

(5) USB connector (Type B)

To connect the product to the computer using the USB interface.

(6) USB connector (Type A)

Enable the storage of product settings information with USB memory.

Also, other devices like a barcode checker, barcode scanner or keyboard can be connected.



- Be sure to perform a virus check on the USB memory before connecting it to the product. SATO Corporation shall not be held responsible for any product malfunctions caused by a virus spread via USB memory.
-

(7) LAN connector

To connect the product to the network using the LAN interface.

(8) AC input terminal

Supplies power to the product through the inserted power cord.

Before connecting, make sure that the AC voltage of your region is in the range of AC 100 to 240 V, 50 to 60 Hz.

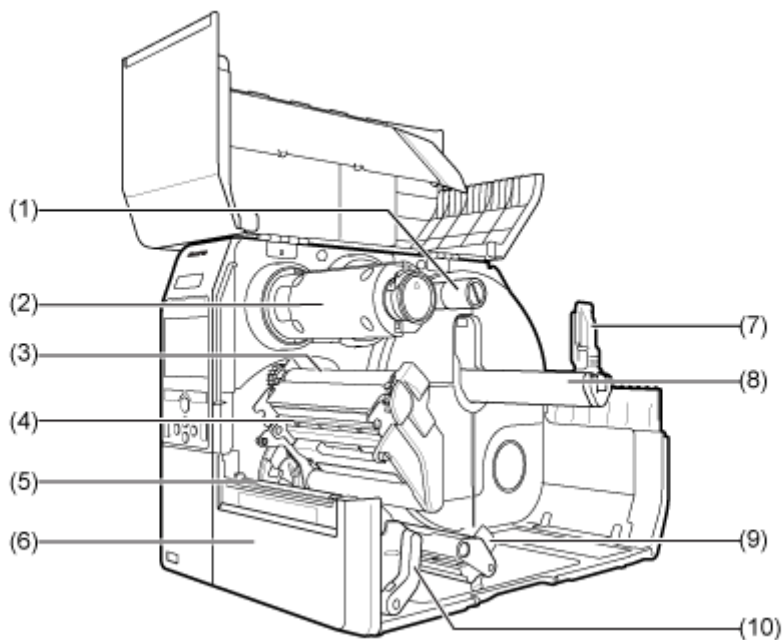
Internal View**(1) Ribbon supply spindle****(2) Ribbon rewind spindle****(3) Ribbon roller****(4) Print head (Consumables)**

Creates an image directly on the media or by using a ribbon. Clean the print head regularly.

(5) Platen roller (Consumables)**(6) Front cover****(7) Media holder guide**

Used to hold the media roll.

(8) Media roll holder

Used to hang the media roll to the bar.

(9) Media guide**(10) Head lock lever**

Used to release the print head assembly.

Parts Identification for the Operator Panel

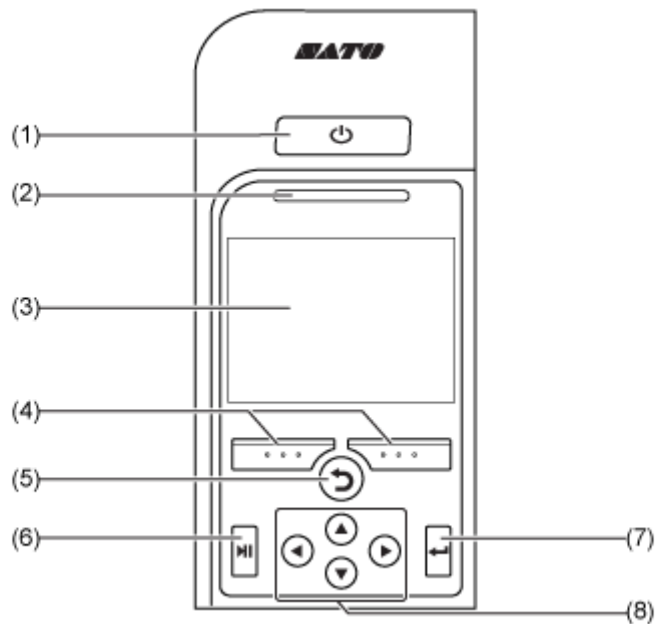

(1)  **Power button**

To power on the product, press the  power button until the LED lights up in blue.

To power off the product, press the  power button for more than two seconds.

(2) **LED indicator**



(3) **Color LCD**

(4)  **Soft buttons**

The functions change depending on the screen. The functions of the buttons are indicated on the bottom of the screen.

Example 1: In Offline mode



 left soft button: ONLINE,  right soft button: FEED

Example 2: The numerical value input screen of the Settings menu

 left soft button: Delete one character,  right soft button: Save

(5)  Back button

Returns to the previous screen.

(6)  Line button

Toggle between Online/Offline mode or playback/pause the video.

(7)  Enter button

Confirm the selected item or setting value.

(8)  Arrow buttons





Navigate the selection in the screen menu.

Using the Operator Panel

Display and Operation of the Operator Panel

LED Indicator

The LED indicator lights up or flashes to show the current status of the product. The product statuses which the LED indicator shows are as follows:

LED Indicator	Color/Status	Description
	Blue/Lights on	Online mode
	Lights off	Power off or Offline mode
	Red/Lights on	Product error (for example, when the ribbon runs out)
	Blue/Flashes at intervals of two seconds	Sleep mode (energy saving mode)



- If the product enters sleep mode during a product error status (LED lights red), the LED indicator will flash blue at intervals of two seconds.
 - By default, the product goes into sleep mode after 60 minutes of inactivity. Use the [Energy Saving] menu to change the period before the product enters sleep mode.
-

Operations in Online/Offline Mode

Online Mode

In Online mode, you can execute the print job.

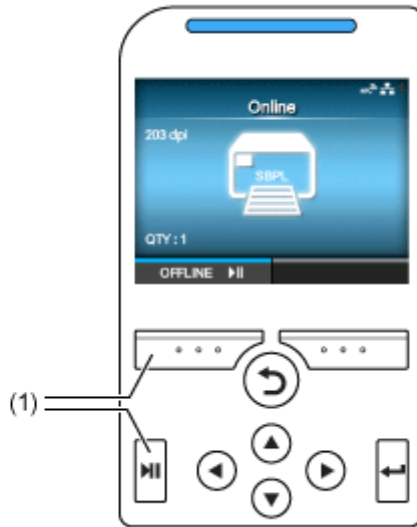

(1) Change to Offline mode.

Offline Mode

In Offline mode, the print job will stop.

You can adjust the print settings, cancel the print job or feed the media.

After you complete or cancel the print job, you can show the Settings mode.



- (1) Cancel the print job.
- (2) Change to Online mode.
- (3) Feed the media.
- (4) Shows the Adjustments mode when the print job is paused.
Shows the Settings mode when there are no print jobs.





Status Icon

The icons on the status bar of the display show the product's status.

















(1) Status bar

Communication Interface Status

Icon	Description
	Bluetooth is enabled but not connected.
	Bluetooth is enabled and connected.
	Network link is enabled but not connected.
	Network link is enabled and connected.
	NFC is enabled but not connected.

Icon	Description
	<p>NFC is enabled and connected.</p>
	<p>Not connected to the NTP time server.</p>
	<p>Wi-Fi is authenticated, but not connected.</p>
	<p>Wi-Fi is connected. Signal Level: 1</p>
	<p>Wi-Fi is connected. Signal Level: 2</p>
	<p>Wi-Fi is connected. Signal Level: 3</p>
	<p>Wi-Fi is connected. Signal Level: 4</p>
	<p>Wi-Fi Direct is not connected.</p>
	<p>Wi-Fi Direct is connected. Signal Level: 1</p>

Icon	Description
	<p>Wi-Fi Direct is connected. Signal Level: 2</p>
	<p>Wi-Fi Direct is connected. Signal Level: 3</p>
	<p>Wi-Fi Direct is connected or the product is set to act as an access point. Signal Level: 4</p>
	<p>Product is connected to USB host.</p>
	<p>Waiting for external input/output signal.</p>
	<p>RFID mode is enabled. (RFID models only)</p>
	<p>RFID mode is enabled, but the system is defective. (RFID models only) Or the SATO RF Analyze (SRA) motor unit is not operating correctly. (RFID models only)</p>
	<p>Standard code is disabled.</p>
	<p>The On-Demand mode of the SOS (SATO Online Services) is enabled.</p>

Icon	Description
	The Real Time mode or the Light mode of the SOS is enabled. The product is connected to the SOS cloud.
	The Real Time mode or the Light mode of the SOS is enabled, but not connected to the SOS cloud. If the LAN or Wi-Fi icon is grayed out, the product is not connected to the network. If the LAN or Wi-Fi icon is active, the Internet connection of the SOS cloud has a trouble.
	The product is not connected to the SOS cloud.
	Time period set for periodic notification for On-Demand mode for SOS has been reached. Scan the QR code and send the information to the SOS cloud.
	IP address could not be acquired. Or a communication error has occurred.

USB Memory Status

Icon	Description
	USB memory is connected.

Barcode Checker Status

Icon	Description
	Barcode checker is connected.

Barcode Scanner Status

Icon	Description
	Barcode scanner is connected in AEP mode.





Print Job Status

Icon	Description
	Waiting for media removal. Remove the media.
	Ribbon is near the end. The rest of the ribbon is decreased. Prepare a new ribbon.
	Label is near the end. The rest of the media is decreased. Prepare new media.
	Command error detected. Check the print data.
	Receive buffer is nearly full. Stop sending print data until the buffer is no longer nearly full.
	Defective print head is detected. Replace the print head.

Icon	Description
	Incompatible print head is detected. Replace the print head.

Maintenance Status

Icons notify you about cleaning the product and replacing parts at the set periods when [Notifications] is enabled.

Icon	Description
	Clean the print head or platen roller.
	Replace the print head.
	Replace the platen roller.
	Replace the cutter unit.

Operations When Errors Occur

When a product error occurs, an icon and message (the error and solution) for the error appear on the display. When an error occurs, you can perform the following operations:

- Change to Offline mode.
- Cancel the error.
- Feed the media.
- Change to Settings mode.
- Change to guidance video.
- Change to the SOS error screen on which the QR code and phone number are displayed if the SOS (SATO Online Services) is enabled.



- The available operations vary, depending on the situation.

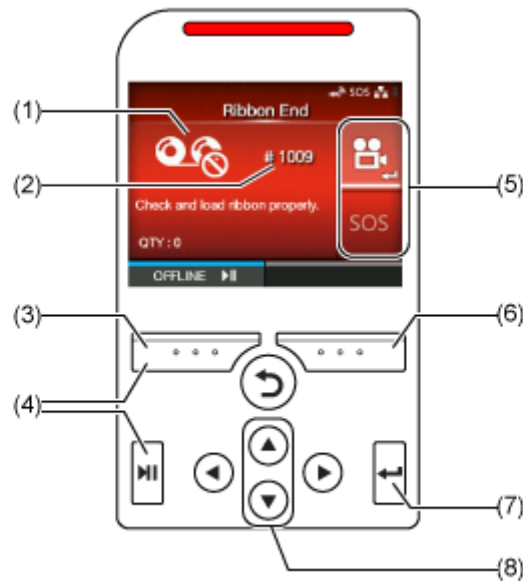



- (1) Error Icon
- (2) Error number
- (3) Clear the error if allowed for the active error.
- (4) Change to Offline mode if allowed for the active error.
- (5) The icon appears when the Settings mode or guidance video is available.
The SOS icon appears when the SOS is enabled.
- (6) Feed the media if allowed for the active error.
- (7) Change to Settings mode or guidance video.









Change to the SOS error screen on which the QR code and phone number are displayed if the SOS is enabled.



- (8) When there are two icons on the (5) area, select the icon by using ▲ / ▼ buttons. The selected icon will be highlighted.

Error Icon

Icon	Description
	Paper end is detected.
	Ribbon end is detected.

Icon	Description
	Print data is larger than the media size.
	Sensor error is detected.
	Print head is unlocked.
	Print head error is detected.
	<ul style="list-style-type: none"> • Communication error is detected. • BCC error is detected. • CRC error is detected.
	Receive buffer overflow.
	Cutter error is detected.
	<ul style="list-style-type: none"> • USB memory is not accessible. • There is no free space in the USB memory.
	Calendar error is detected.

Icon	Description
	<ul style="list-style-type: none"> • Writing/reading information to/from the RFID tag failed. (RFID models only) • With [RFID Undetected Warning] enabled and RFID tag loaded, the items received do not contain an RFID issue command.(RFID models only)
	<ul style="list-style-type: none"> • Wireless LAN setting error is detected. • Wireless LAN module is defective. • Authentication with the server failed. • Authentication with the server timed out.
	<ul style="list-style-type: none"> • No print head installed or head resolution was changed. • Product error was detected. • The power was cut off in an inappropriate way. • An unsupported optional device is installed.
	<p>The temperature of the print head has exceeded the tolerance range.</p>
	<ul style="list-style-type: none"> • RFID module is defective. (RFID models only) • SATO RF Analyze (SRA) board setting error is detected. (RFID models only) • SATO RF Analyze (SRA) board is not connected. (RFID models only) • SATO RF Analyze (SRA) motor unit is defective. (RFID models only)
	<p>Bluetooth module is defective.</p>
	<p>Paper jam is detected. (CL4NX Plus only)</p>
	<p>NFC error is detected.</p>
	<p>NFC command error is detected.</p>

Icon	Description
	The barcode checker is not detected at product startup or at the start of printing when the barcode check mode is enabled.
	<ul style="list-style-type: none"> The barcode could not be read. The read result of the barcode does not match the command data.

Guidance Videos

The product contains guidance videos that are shown on the display for visual reference of the product's operations.

List of the Guidance Videos

The product contains the following guidance videos for visual reference of product operations.

The onboard guidance videos are as follows:

No.	Guidance Videos	Show video from		
		Error screen	Startup Guide	[Information] Menu
1	Media roll loading (Standard)	-	Possible	Possible
2	Media roll loading (Cutter) ¹	-	Possible	Possible
3	Media roll loading (Rotary cutter) (CL4NX Plus only) ¹	-	Possible	Possible
4	Media roll loading (Linerless) (CL4NX Plus only)	-	Possible	Possible
5	Media roll loading (Dispenser)	-	Possible	Possible
6	Media roll loading (Dispenser with rewinder)	-	Possible	Possible
7	Fan-fold media loading (Standard)	-	Possible	Possible
8	Fan-fold media loading (Cutter) ¹	-	Possible	Possible

No.	Guidance Videos	Show video from		
		Error screen	Startup Guide	[Information] Menu
9	Fan-fold media loading (Rotary cutter) (CL4NX Plus only) ¹	-	Possible	Possible
10	Ribbon loading	-	Possible	Possible
11	Media roll replacement (Standard)	Possible	-	Possible
12	Media roll replacement (Cutter) ¹	Possible	-	Possible
13	Media roll replacement (Rotary cutter) (CL4NX Plus only) ¹	Possible	-	Possible
14	Media roll replacement (Linerless) (CL4NX Plus only)	Possible	-	Possible
15	Media roll replacement (Dispenser)	Possible	-	Possible
16	Media roll replacement (Dispenser with rewinder)	Possible	-	Possible
17	Fan-fold media replacement (Standard)	Possible	-	Possible
18	Fan-fold media replacement (Cutter) ¹	Possible	-	Possible
19	Fan-fold media replacement (Rotary cutter) (CL4NX Plus only) ¹	Possible	-	Possible
20	Ribbon replacement	Possible	-	Possible
21	Print head replacement	-	-	Possible
22	Platen roller replacement	-	-	Possible
23	Cleaning	-	-	Possible

¹ If you select the video for the cutter on the product while the optional rotary cutter unit is installed, the procedure for the product with the rotary cutter unit installed will be shown. If other options have been installed or no option has been installed, the procedure for the product with the optional cutter unit installed will be shown.

Playing the Guidance Video from the Error Screen

Play the guidance video from the error screen and resolve the error by following the procedure of the video.

1. On the error screen, press the  button to play the guidance video.



If there are more videos to choose from, press the arrow buttons to select the guidance video, and then press the  button. The guidance video starts.

2. Follow the procedures to resolve the error according to the guidance video.

Getting Access to the Guidance Video in Online Mode

When in the Online mode, play the guidance video according to the following procedure.

1. Press the  button in Online mode.



The product changes to Offline mode.

2. Press the  button.



The product changes to Settings mode.

3. Select [Information] using the  /  buttons.

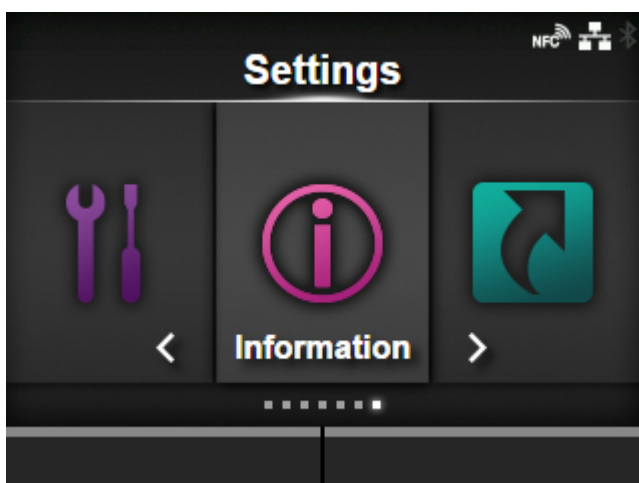

4. Press the  button.

The item list appears.

5. Select [Help] using the ▲ / ▼ buttons.

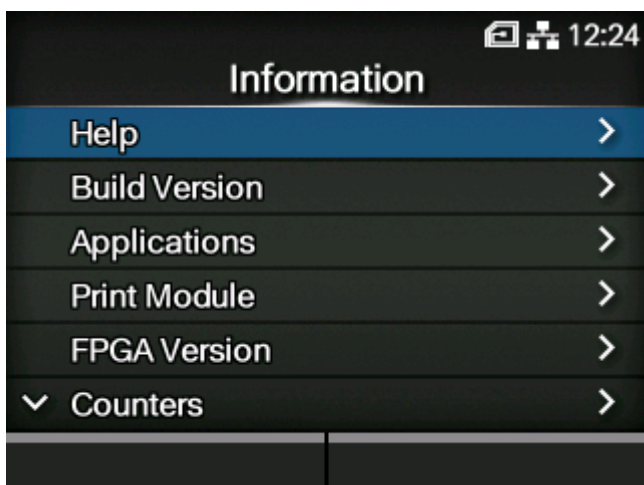

6. Press the ← button.

The guidance video list appears.

7. Select the video for playback using the ▲ / ▼ buttons, and then press the ← button.

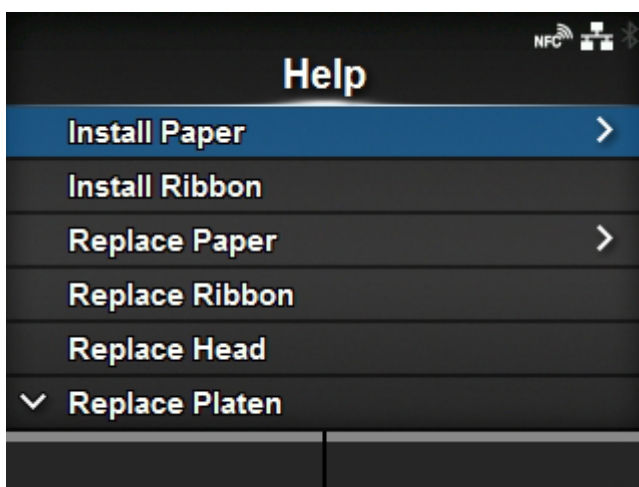

The guidance video starts.

Operating the Guidance Video

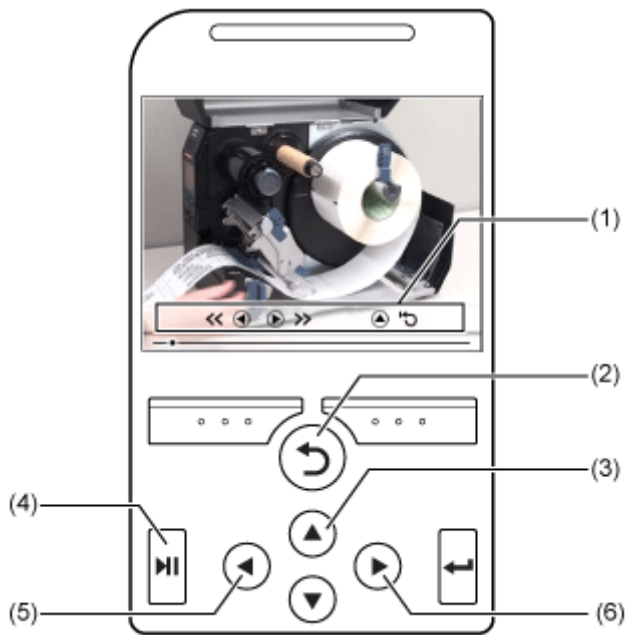

- (1) Indication panel appears again when one of the buttons is pressed.
- (2) Stop the playback of the video and return to menu.
- (3) Playback the video from the start.
- (4) Playback or pause the video.
- (5) Rewind the video.
- (6) Fast-forward the video.

Adjusting the Print Settings During Printing

Follow the procedure below to adjust the print position, print darkness and print speed during printing.

1. Press the  button to pause print job and change the product to Offline mode.

2. Press the  button.



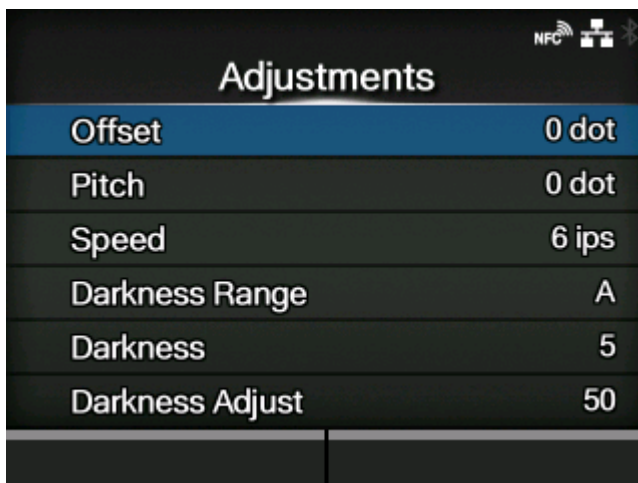

The Adjustments mode appears.

3. Select an item and adjust the setting.



Adjustments	
Offset	0 dot
Pitch	0 dot
Speed	6 ips
Darkness Range	A
Darkness	5
Darkness Adjust	50

4. Press the  button to return to Offline mode.
5. Press the  button to change to Online mode.



The print job resumes with the adjusted settings.



- When [Printing] > [Advanced] > [Prioritize] menu has been set to [Commands] and the print settings have been specified by command, the changes made in the Adjustments mode will be applied only to the data already analyzed at that time. The settings specified by command will be applied to the rest of the data.

Canceling the Print Job

Cancel the print job according to the following procedure. When the print job is canceled, the data stored in the receive buffer of the product is also deleted.

1. Press the  button to change the product to Offline mode.
2. Press the  button.



A message appears, confirming that you want to cancel the print job.

3. Press the  button.

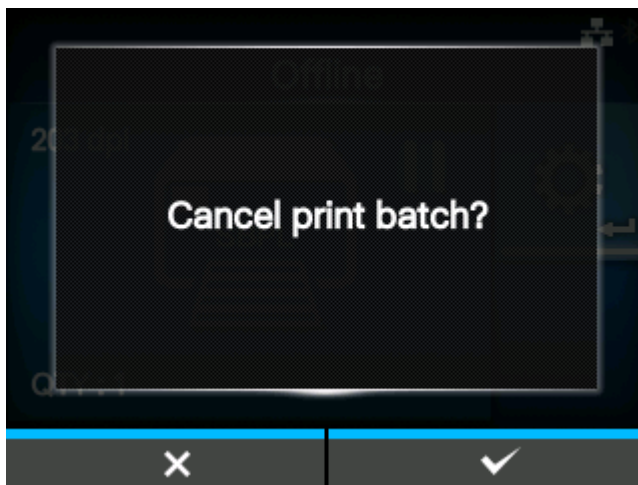

The print job is canceled.

Settings Mode

In the Settings mode, you can set the product's various settings. The topics here explain how to operate the Settings mode.

Settings Mode Menus

There are six main menus in the Settings mode and each menu contains many layers of submenus. Frequently used settings are also listed in the [Shortcut] menu so that you can directly access them.



Menu	Description
Shortcut Menu	Directly access frequently used settings.
Printing Menu	Access the settings related to printing.
Interface Menu	Access the settings related to the interfaces.
Applications Menu	Access the settings related to the printer command.
System Menu	Access the settings related to the display language, buzzer volume etc.
Tools Menu	Access the test print, initialization and other settings.
Information Menu	Displays the information and guidance videos for the product.



The  icon appears between the [Information] menu and [Shortcut] menu when the [System] > [Regional] > [Display Language Icon] menu is enabled. You can easily access the [Language] menu.

Changing to the Settings Mode

The Settings mode appears when no print jobs remain in the product.

Change the product to the Settings mode according to the following procedure:

1. Press the  button in Online mode.



The product changes to Offline mode.

2. Press the  button.



The product changes to Settings mode.

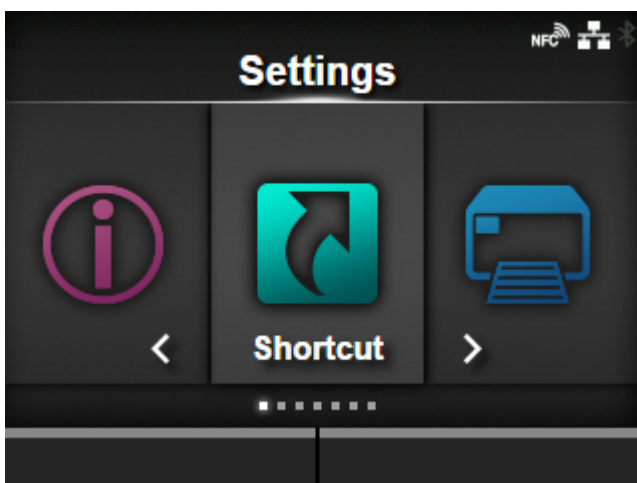



- To exit the Settings mode, press the  button.

Logging In to/Logging Out of the Settings Mode

The Settings mode logs in and logs out by the following procedure, if the password is enabled.

- If the password is enabled, input the password after entering the Settings mode.

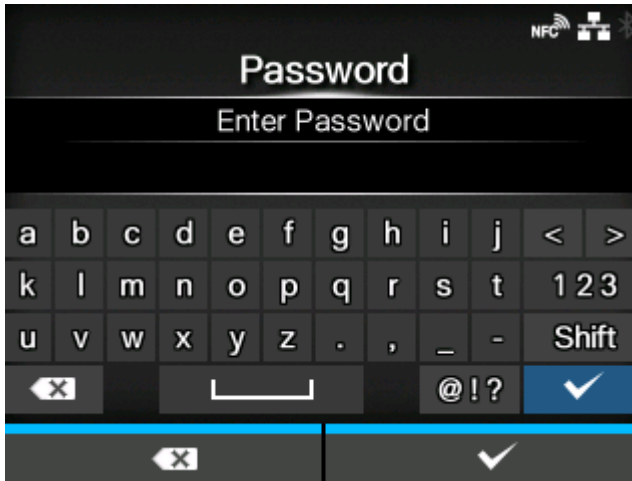

When logged in to the Settings mode, [LOG OUT] appears on the bottom left of the screen.

- Press the  button to log out of the Settings mode.

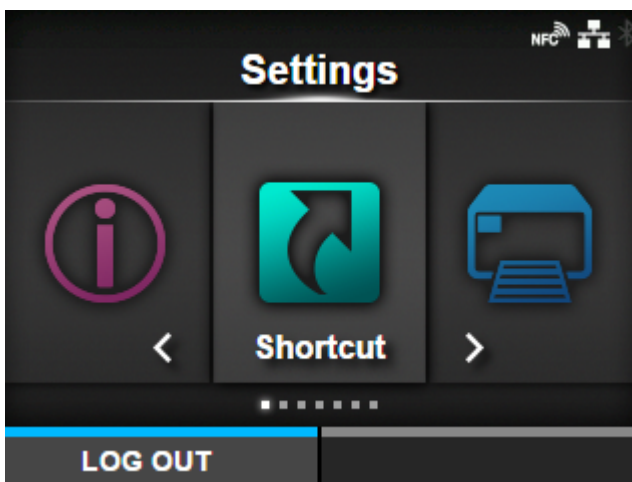

Password is required to enter the Settings mode again.



- With password enabled, if no button is pressed for about 10 minutes after login, the login session will end automatically. Password is required to enter the Settings mode again.

Item Selection

Select an item in Settings mode according to the following procedure:

1. Select menu using the ◀/▶ buttons.
2. Press the ◀ button.

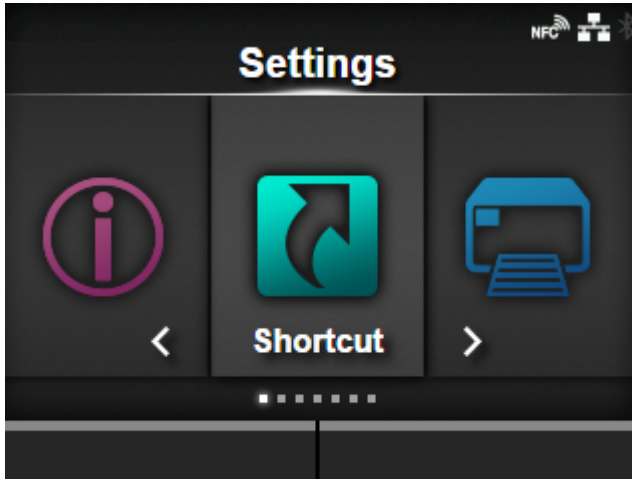

The item list appears.

3. Select an item using the ▲ / ▼ buttons.
4. Press the ◀ button.

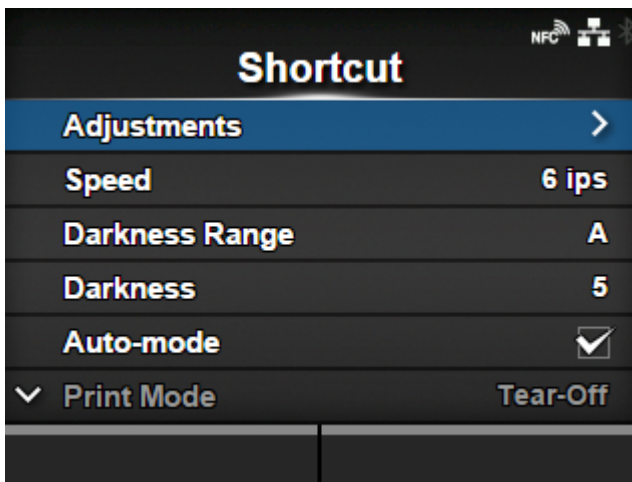

If the selected item is a setting item, the setting screen appears.

If the selected item is a handling item such as the auto calibration, copy, or delete, the starting screen or confirmation screen appears.

Items with a [>] indicated on the right side have more items in the next layer of the submenu.

Press the ▶ or ◀ button to show the next layer.

Similarly, select an item using the ▲ / ▼ and ◀ buttons.

Press the ↶ button to return to the previous screen.

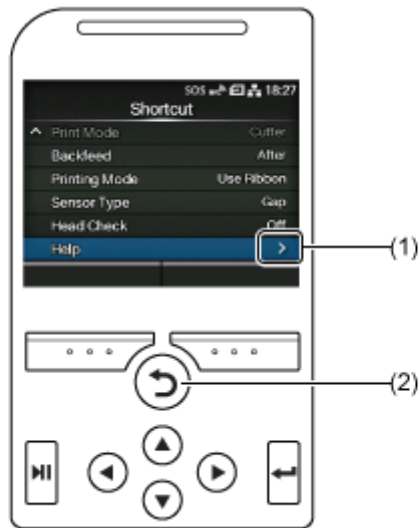

(1) There are more items in the next layer.

(2) Return to the previous screen.

Setting Value Input or Selection

This topic describes the character and number input on the setting screen and how to select an item from the list.



- You can also input characters and numbers from a USB keyboard by connecting it to the product.

- [Character Input](#)
- [Numeric Input](#)
- [Selection from the List](#)
- [Selection from the Box](#)
- [IP Address Input](#)

- **Character Input**

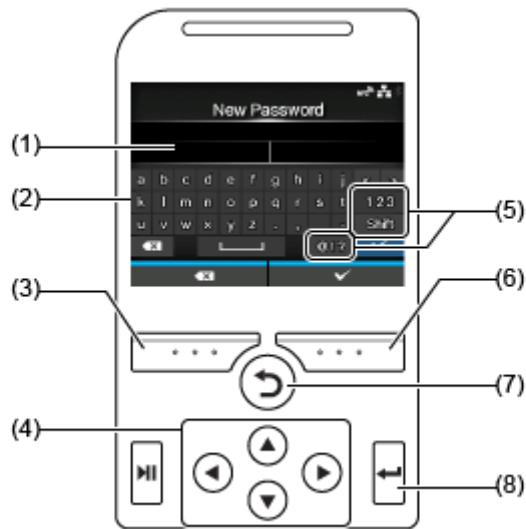

- (1) Text box
- (2) Selection area
- (3) Delete the character displayed to the left of the cursor in the text box.
- (4) Select the character for input using the arrow buttons. The selected character will be highlighted in the selection area.
- (5) Change the input mode.
- (6) Save the character you enter in the text box and return to the item list.
- (7) Cancel the character you enter in the text box and return to the item list.
- (8) Enter the selected character into the text box.

- **Numeric Input**

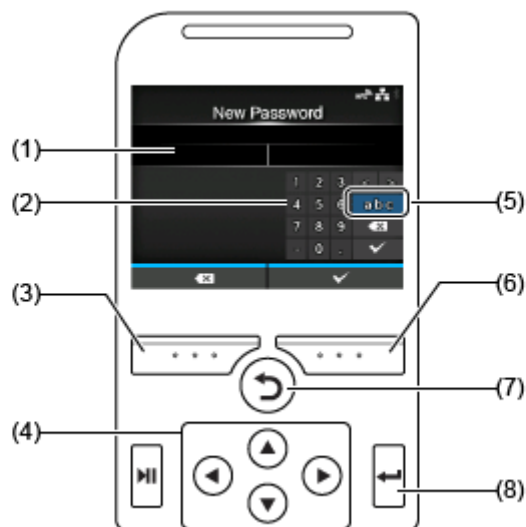

- (1) Text box

- (2) Selection area
- (3) Delete the number displayed to the left of the cursor in the text box.
- (4) Select the number for input using the arrow buttons. The selected number will be highlighted in the selection area.
- (5) Change the input mode.
- (6) Save the number you enter in the text box and return to the item list.
- (7) Cancel the number you enter in the text box and return to the item list.
- (8) Enter the selected number into the text box.

- **Selection from the List**



- (1) Selection area
- (2) Select an item using the ▲ / ▼ buttons. The selected item will be highlighted in the selection area.
- (3) Save the selection from the list and return to the item list.
- (4) Cancel the selection from the list and return to the item list.

- **Selection from the Box**

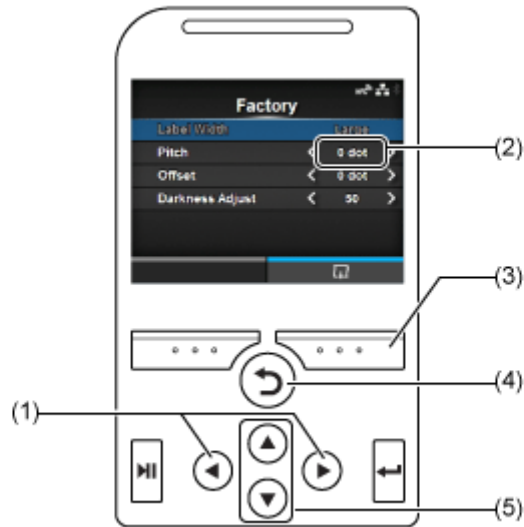

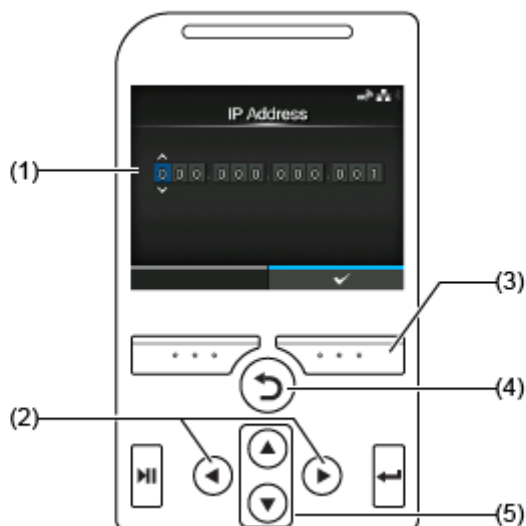

- (1) Change the value in the selection box using the ◀/▶ buttons.
- (2) Selection box
- (3) Perform the function as shown on the screen above.
- (4) Return to the previous screen.
- (5) Select an item using the ▲/▼ buttons. The selected item will be highlighted in the selection area.

- **IP Address Input**



- (1) Text box
- (2) Select the digit for input using the ◀/▶ buttons.
- (3) Save the IP address you enter in the text box and return to the item list.

- (4) Cancel the IP address you enter in the text box and return to the item list.
- (5) Select the number to input using the  /  buttons.

Product Memory and USB Memory

The memory of the user area of the product is a maximum of 679 MB.

However, you cannot use the whole memory of the user area, because this area is also used for the log data and HEX dump functions.

USB memory can be connected to the product. There is no capacity limit for USB memory.

There are two USB connectors (Type A) at front and back of the product. USB memory can be connected to either connector.

What you can do with this product while it is connected to USB memory is as follows:

- Get the HEX dump data
- Install certificates used for Wi-Fi authentication and for HTTPS
- Get the barcode check log data
- Create clone data (copy the product's settings information)
- Get the support information



- Be sure to perform a virus check on the USB memory before connecting it to the product. SATO Corporation shall not be held responsible for any product malfunctions caused by a virus spread via USB memory.



- The product does not support USB memory with security functions such as fingerprint authentications.
 - The product does not support connection through the USB HUB.
-

Getting Started

Installation

Installation Precautions

Install the product in a location as follows:

- A location that is horizontal and stable.
- A location that has sufficient space for operating the product.

Do not install the product in a location as follows. Doing so could cause the product to malfunction.

- A location that is subject to vibration.



- A location with high temperature and humidity.



- A dusty location.



- A location exposed to direct sunlight.



- A location with a lot of electrical noise.

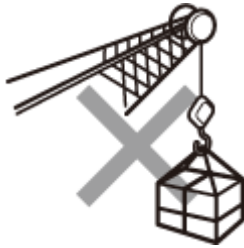

- A location with a large fluctuation in power.



- A location with an explosive atmosphere (flammable gas or vapor).
- A location with high-temperature, near heating equipment such as a cooking appliance or heater.

Installation Space

Front View

Make sure that there is sufficient space around the product so that the top cover can be fully opened when operating or cleaning the product, or replacing consumables.

The dimensions of the front view of the product are as follows:

CL4NX Plus

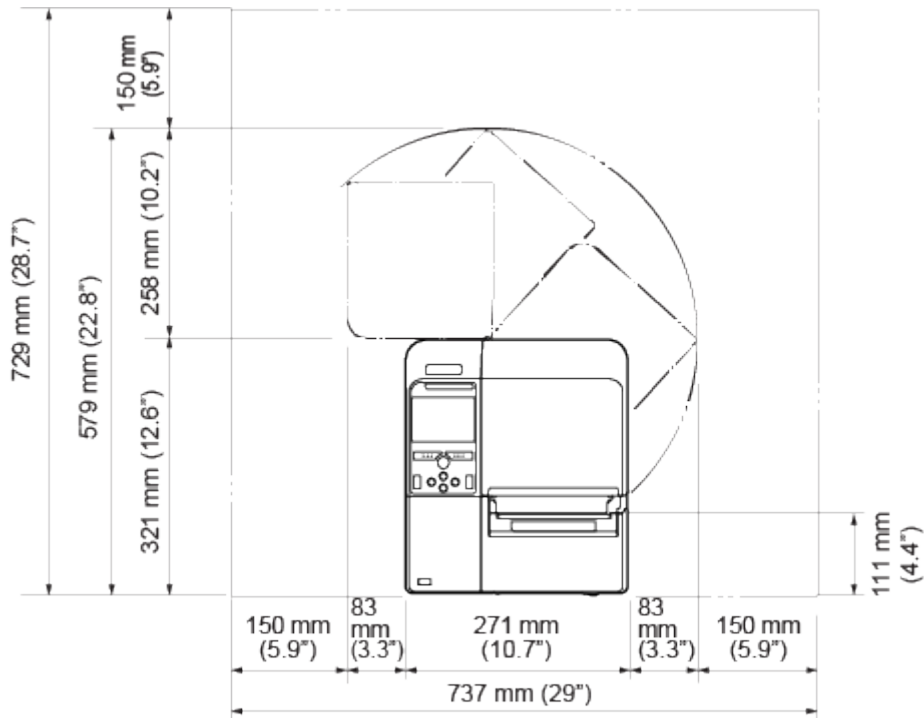

- The image above is the standard model.

CL6NX Plus

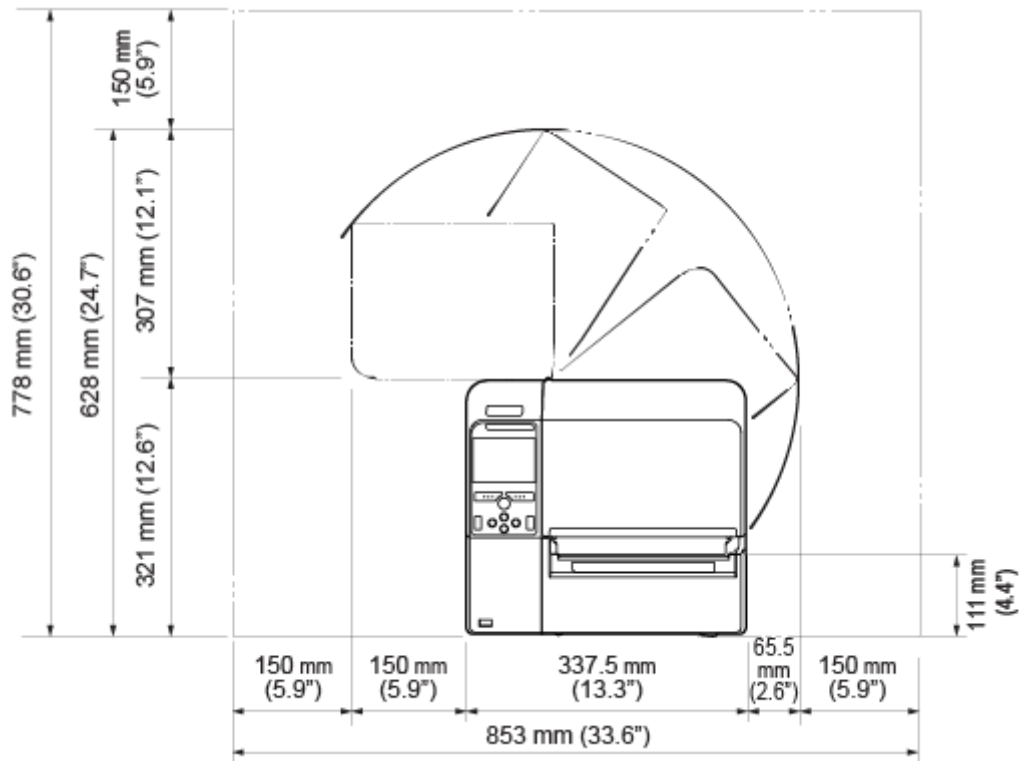

- The image above is the standard model.

Side View

Make sure that there is sufficient space around the product so that the top cover can be fully opened when operating or cleaning the product, or replacing consumables.

Make sure that there is sufficient space on the rear side of the product so that no stress is applied to the power cord or cables connected to the product.

The dimensions of the side view of the product are as follows:

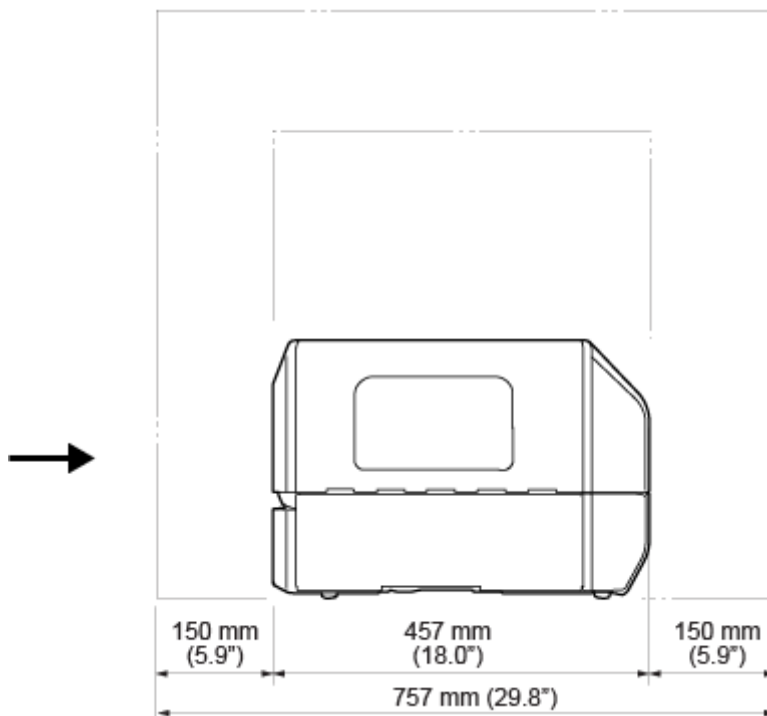

- The arrow indicates the front of the product.

Bottom View

The bottom surface dimensions of the product are as follows:

CL4NX Plus

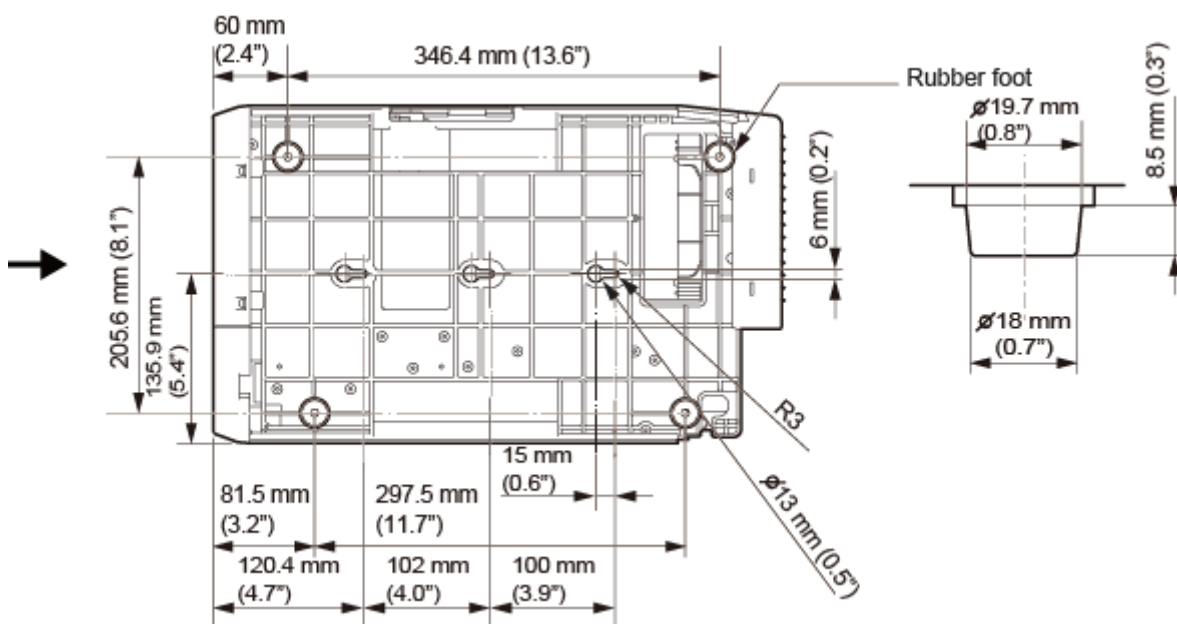

- The arrow indicates the front of the product.

CL6NX Plus

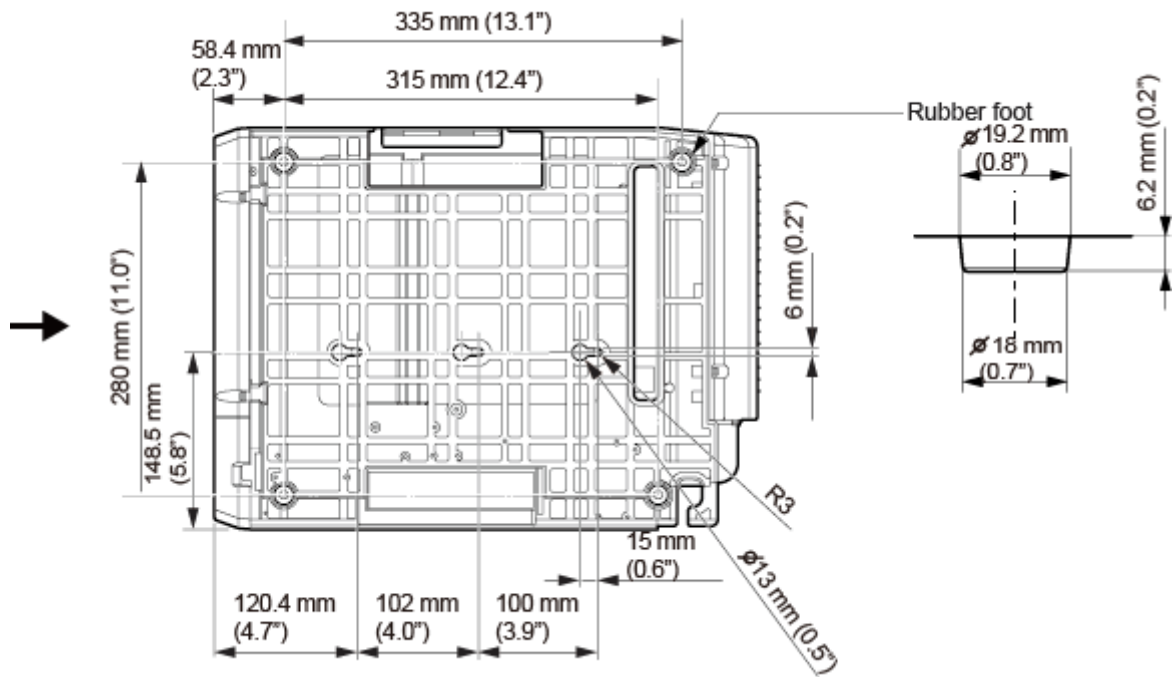

- The arrow indicates the front of the product.

Powering On/Off the Product

Connecting the Power Cord



- Do not power on or off the product, connect or disconnect the power cord while your hands are wet. Doing so could cause an electric shock.
- Always connect the ground wire to a ground terminal. Electric shock could occur if you do not.
- Make sure that the AC voltage of your region is in the range of AC 100 - 240 V, 50 - 60 Hz. If your local voltage is not in the stated range, contact your SATO reseller or technical support.



- The attached power cord is designed exclusively for this product. Do not use it with other devices.

1. Connect the power cord to the AC input terminal (1) at the rear of the product.

Take note of the orientation of the connector. Secure the product with one hand, and insert the connector tightly.

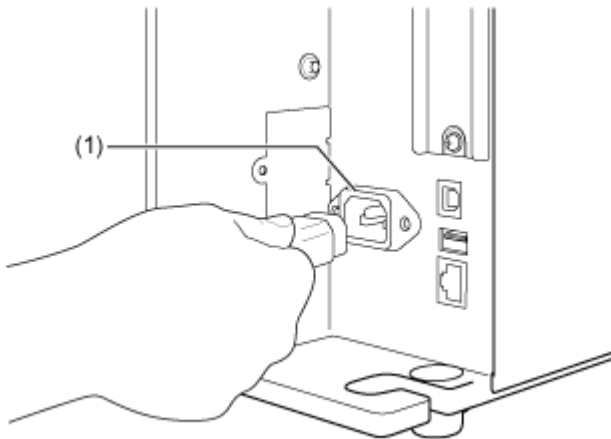

2. Insert the power plug into an AC outlet.

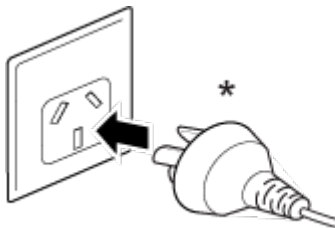



* The shape of the power plug varies depending on the region in which it was purchased.



- This product is also designed for IT power distribution system with phase-to-phase voltage 230 V.
-

Powering On the Product

-
- 
 Do not power on or off the product, connect or disconnect the power cord while your hands are wet. Doing so could cause an electric shock.
-

- 
 You can power on/off the product from the main power source by enabling [Start on AC] under the [System] menu.
-

- Press the  power button of the operator panel until the LED lights up in blue to power on the product.

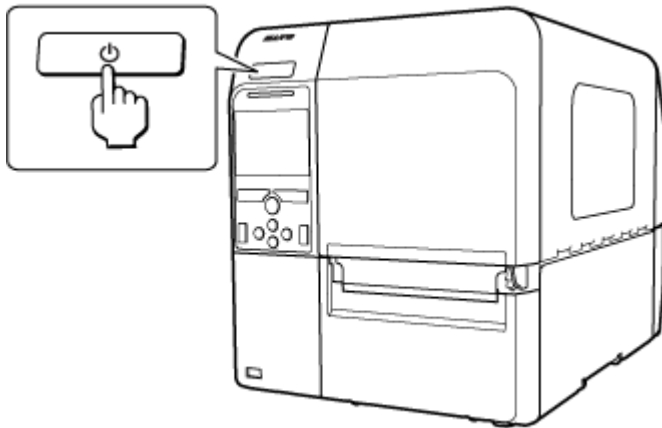

"Online" appears on the screen.



Powering Off the Product



- Do not power on or off the product, connect or disconnect the power cord while your hands are wet. Doing so could cause an electric shock.
-



- Do not power off the product during operation, such as when printing or updating. Doing so could cause a malfunction of the product.
 - Do not disconnect the power cord until the powering off process is completed on the product.
 - An incorrect power on/off operation may damage the product settings. In such a case, the product settings are reset to their initial values. It is always recommended to use the power button to allow proper shutdown of the product and ensure changes made to menu settings are saved appropriately.
-



- You can power on/off the product from the main power source by enabling [Start on AC] under the [System] menu.
-

1. Make sure that the product is in Offline mode before you power off.



If "Online" appears on the screen, press the  button to change to Offline mode.

2. Press the  power button for more than two seconds to power off the product.

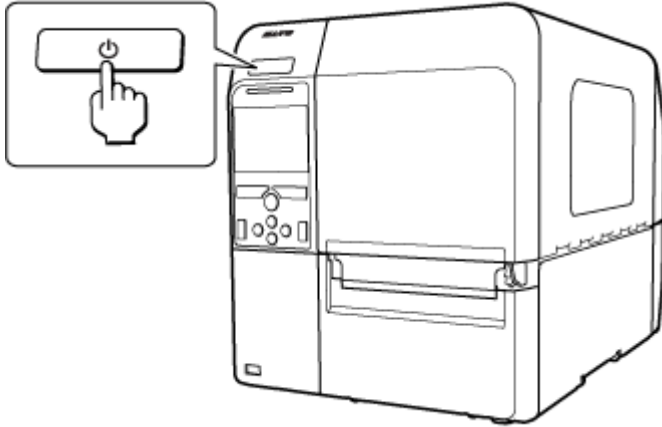

Initial Setup (Startup Guide)

The topics here explain how to complete the startup guide that appears when you power on the product for the first time after purchase.

Overview of the Startup Guide

When you power on the product for the first time after purchase, the display shows the startup guide. The startup guide is a function to help you through the initial product settings, such as setting date and time, and loading the ribbon and media.

You can cancel the startup guide and perform the configuration later from the menu.



- If you have installed the optional RTC (Real Time Clock) kit, the time zone, date and time setting screens appear.

The startup guide lets you configure the product by the following flow:

1. Startup Screen

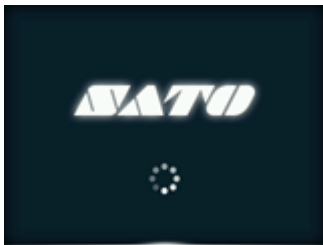

2. Language Selection

Select the display language.

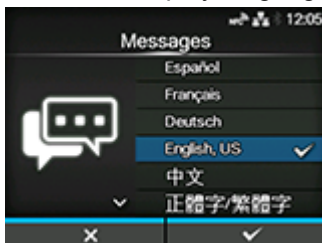

3. Region Setting with Optional RTC Kit

Set the region (time zone).

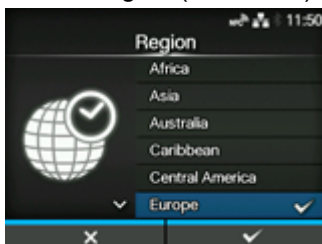

4. City Setting with Optional RTC Kit

Set the city (time zone).



5. Date Setting with Optional RTC Kit

Set the date.

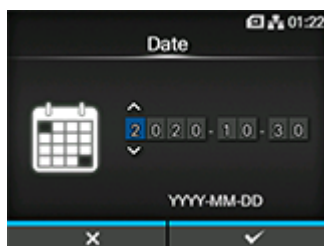

6. Time Setting with Optional RTC Kit

Set the time.

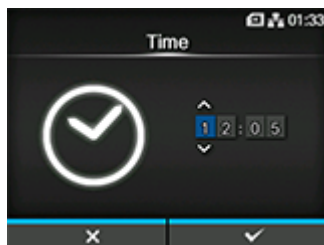

7. Print Method Setting

Set whether to use the ribbon or direct thermal media to print.

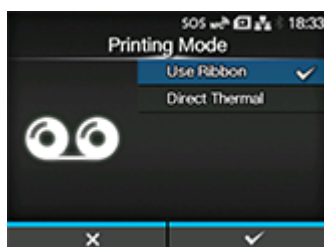

8. Ribbon Setting

Load the ribbon.

Appears if you have selected [Use Ribbon] in the print method setting.

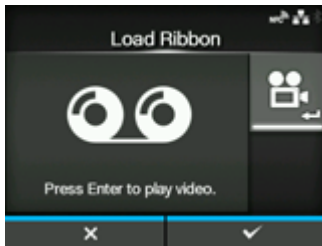

9. Media Sensor Type Setting

Set the sensor type for detecting the media.

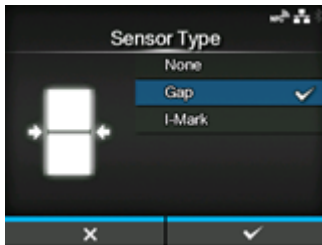

10. Media Setting

Load the media.

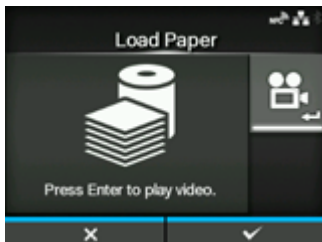

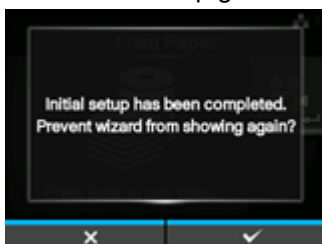

11. Completion of Initial Setup Screen

Finish the startup guide.



Startup Guide Cancellation

To cancel the startup guide in the middle of the configuration, press the  button.

Select whether or not to show the startup guide during the next startup, and press the  button to confirm.

Startup Screen

When you power on the product for the first time after purchase, the display shows the startup guide.

1. Press the  power button of the operator panel until the LED lights blue to power on the product.

The startup screen appears.

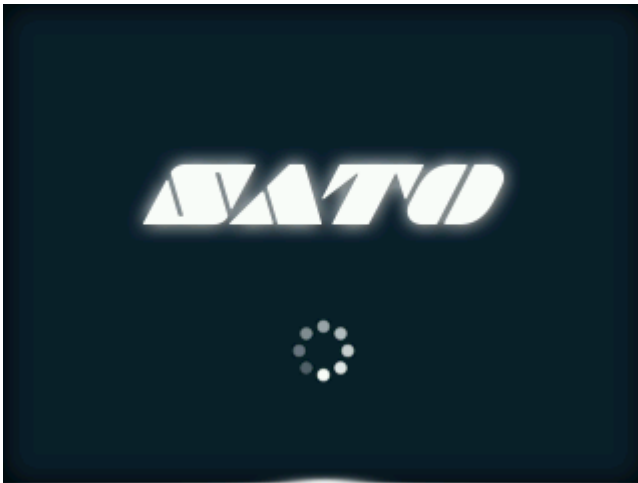

Language Selection

Select the display language.

1. Select the language name using the ▲ / ▼ buttons.



2. Press the  button or  button to confirm.

Region Setting with Optional RTC Kit

Set the region (time zone).

1. Select the region using the ▲ / ▼ buttons.

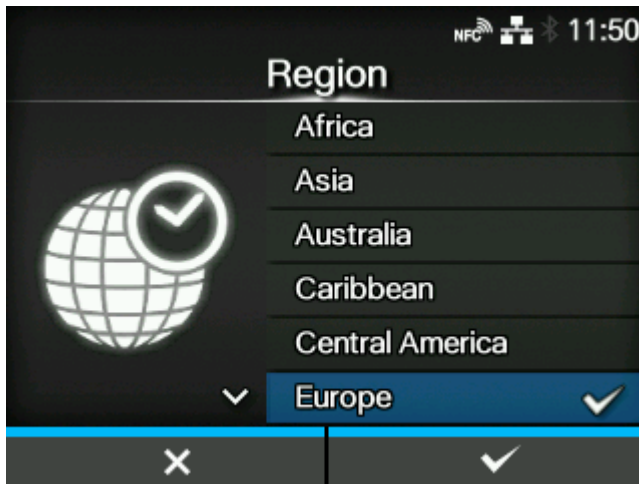

2. Press the  button or  button to confirm.

City Setting with Optional RTC Kit

Set the city (time zone).

1. Select the city using the ▲ / ▼ buttons.



2. Press the  button or  button to confirm.

Date Setting with Optional RTC Kit

Set the date.

1. Select the current value using the ▲ / ▼ buttons, and move the cursor using the ◀ / ▶ buttons.

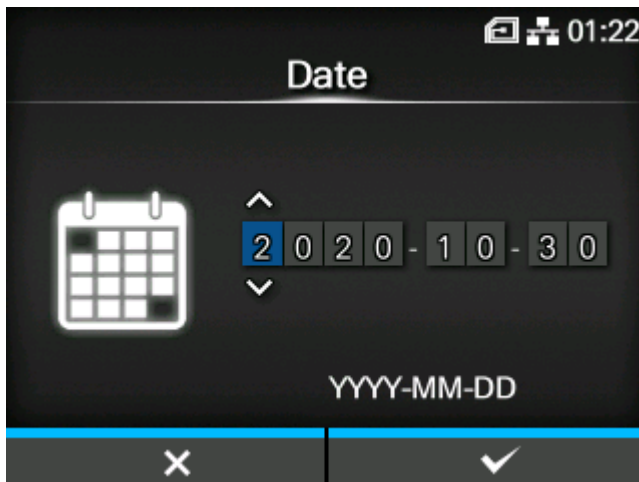

2. When you have completed the date setting, press the  button or  button.

The confirmation screen appears.

3. Press the  button to confirm.

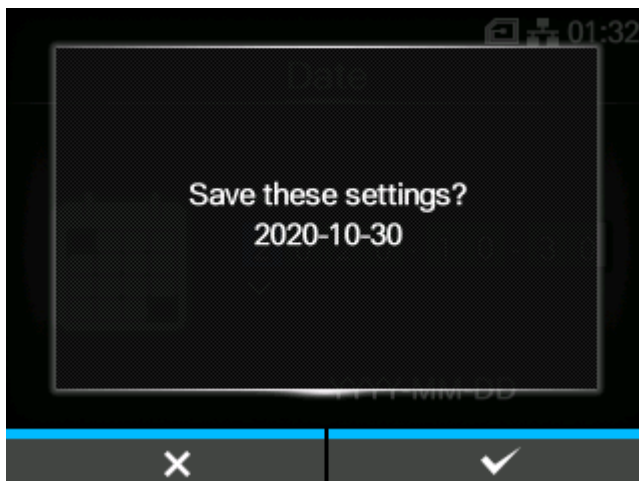

Time Setting with Optional RTC Kit

Set the time.

1. Select the current value using the ▲ / ▼ buttons, and move the cursor using the ◀ / ▶ buttons.

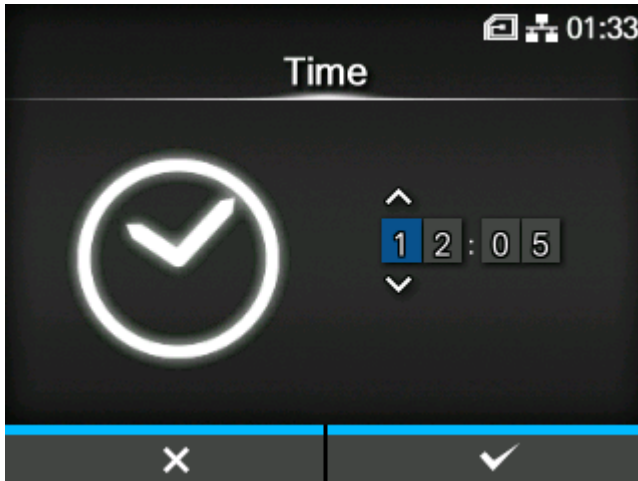

2. When you have completed the time setting, press the  button or  button.



- The time is set in 24-hour format.

The confirmation screen appears.

3. Press the  button to confirm.

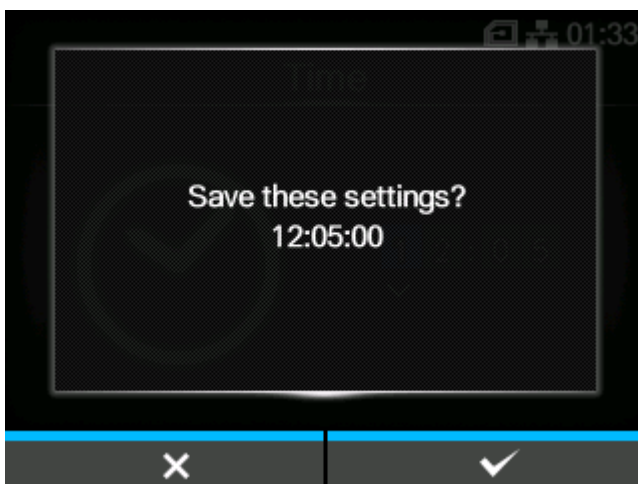

Print Method Setting

Set whether to use the ribbon or direct thermal media to print.

1. Select the print method using the ▲ / ▼ buttons.



[Use Ribbon]

Print using a ribbon.

[Direct Thermal]

Print using direct thermal media.

2. Press the  button or  button to confirm.

If you have selected [Use Ribbon], the ribbon setting screen appears.

If you have selected [Direct Thermal], the media sensor type setting screen appears.

Ribbon Setting

Load the ribbon. You can check the loading method of the ribbon through the video.

- Appears if you have selected [Use Ribbon] in the print method setting.

1. Press the  button to play the video.

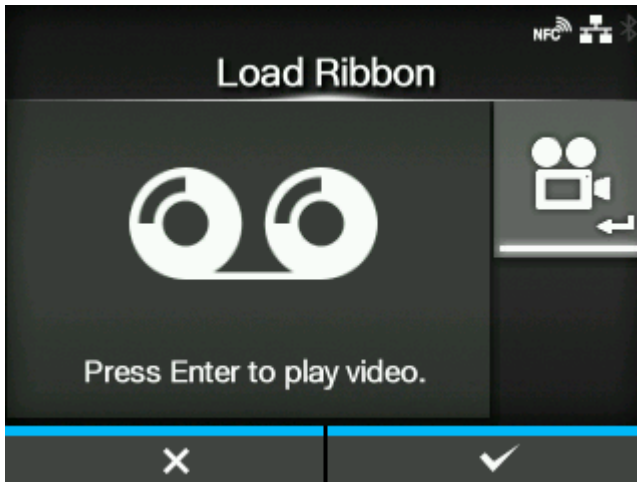

The video starts.



2. Load the ribbon while checking the video.
3. After you complete the ribbon setting, press the  button to stop the video.

The display returns to the previous screen.

4. Press the  button to go to the next screen.

Media Sensor Type Setting

Set the sensor type for detecting the media.

1. Select the media sensor type using the  /  buttons.

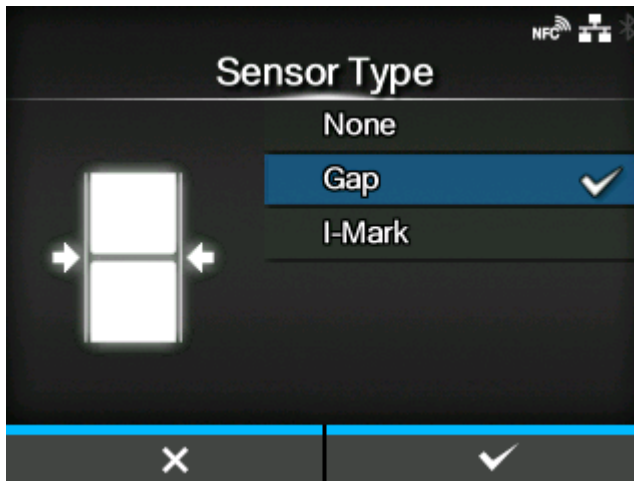

[None]

Disable the media sensor.

[Gap]

Select this option when using gap type media. Use the transmissive type sensor.

[I-Mark]

Select this option when using I-mark type media. Use the reflective type sensor.



- The available options will vary depending on the [Print Mode] set on the product. The initial value of [Print Mode] differs depending on the options installed on the product.
 - If [Print Mode] is set to [Tear-Off], [Dispenser], or [Cut & Print], only [Gap] and [I-Mark] will be available.
 - For CL4NX Plus, if [Print Mode] is set to [Linerless], only [None] and [I-Mark] will be available.

2. Press the  button or  button to confirm.

Media Setting

Load the media. You can check the loading method of the media through the video.

1. Press the  button.

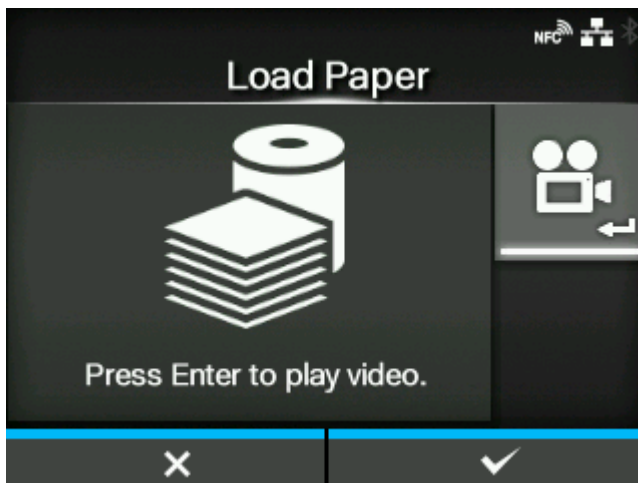

For the models other than the CL4NX Plus linerless model, the selection screen of the video for playback appears. Proceed to step 2.

For the CL4NX Plus linerless model, the video appears immediately after the  button is pressed. Proceed to step 4.

2. Select the video to playback using the  /  buttons.

For Standard Model and Cutter Model

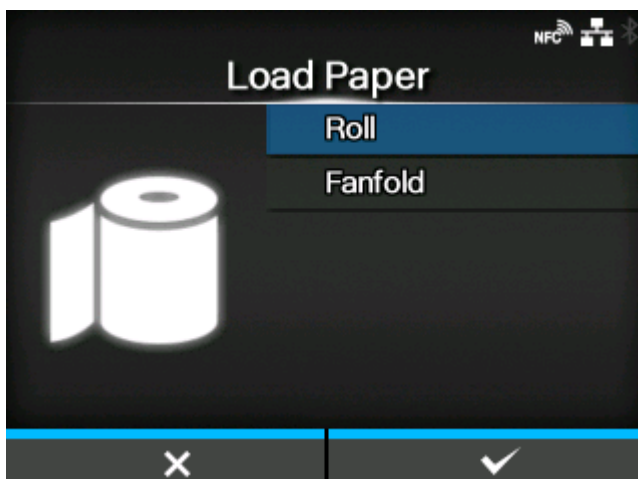

[Roll]

Shows the video on how to load the media roll.

[Fanfold]

Shows the video on how to load the fan-fold media.

For Dispenser Model

**[Dispenser]**

Shows the video on how to eject the liner out of the product.



[Rewinder]

Shows the video on how to rewind the liner in the product.

3. Press the  button or  button.

The video starts.



4. Load the media while checking the video.
5. After you complete the media setting, press the  button to stop the video.
The display returns to the previous screen.
6. Press the  button to go to the next screen.

Completion of Initial Setup Screen

When the startup guide completes, the completion of initial setup screen appears.

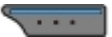
1. If you want the startup guide to show the next time you start up, press the  button. If not, press the  button.

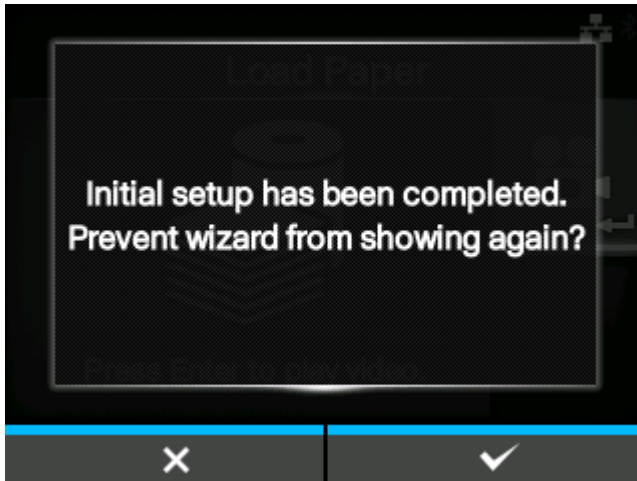

When you press one of the soft buttons, the product automatically feeds the media (to the print head position) and changes to Online mode.



- You can enable or disable the startup guide in [Startup Guide] under the [Tools] menu.
-

Startup Guide Cancellation

You can cancel the startup guide at any time.

1. Press the  button while configuring the startup guide.

The screen to confirm whether or not to show the startup guide again appears.

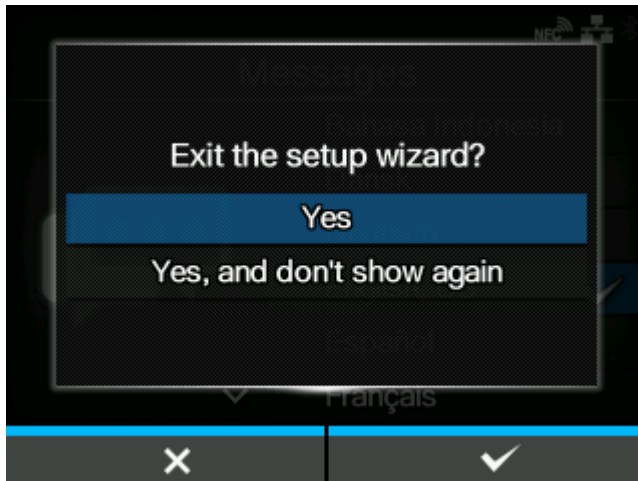

2. Select whether or not to show the startup guide during the next startup using the  /  buttons, and press the  button to confirm.

Press the  button to return to the startup guide setting without canceling it.



- You can enable or disable the startup guide in [Startup Guide] under the [Tools] menu.
 - Even if you cancel the startup guide before completing it, the product will save the settings you have changed.
-

Configuring the Product According to Media and Options

Before starting to print with the product, configure the product according to the media to be used and the installed options.

Print Method

The product supports two types of print methods, thermal transfer and direct thermal.

Thermal transfer

Prints using a ribbon.

Direct thermal

Prints using direct thermal media.



- Ribbon is not necessary if you are using direct thermal media.
-

Change the print method according to the following procedure:

1. Press the  button in Online mode.



The product changes to Offline mode.

2. Press the  button.



The product changes to Settings mode.

3. Select [Printing] using the  buttons.

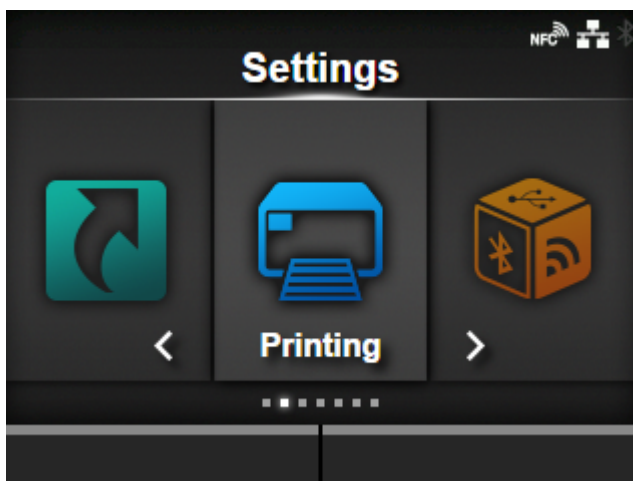

4. Press the  button.

The item list appears.



5. Select [Printing Mode] using the ▲ / ▼ buttons.



6. Press the ← button.

The [Printing Mode] screen appears.

7. Select the print method using the ▲ / ▼ buttons.

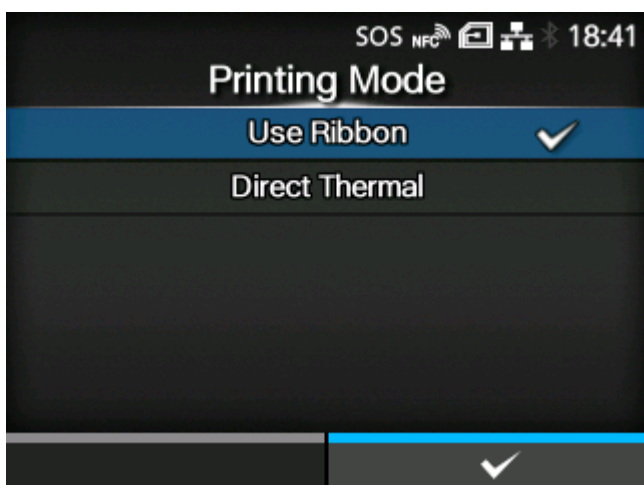

[Use Ribbon]

Prints using a ribbon.

[Direct Thermal]

Prints using direct thermal media.

8. Press the ⏹ button to confirm.

Media Sensor Type

The product adjusts the print position precisely by detecting I-marks or gaps on the media (label) using media sensors.

The I-marks or gaps on each type of media are as follows:

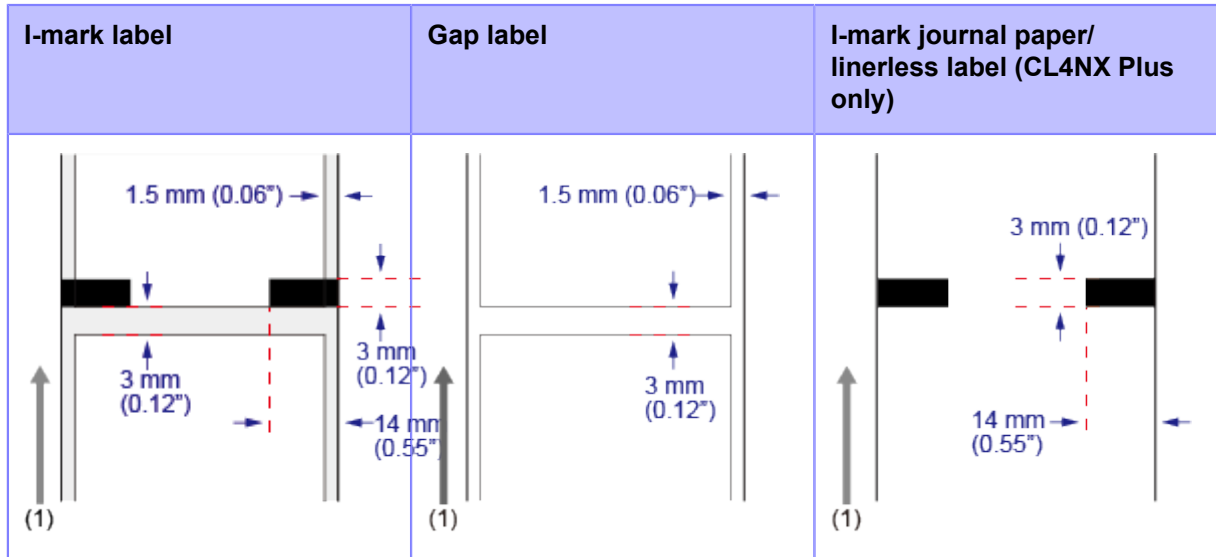

(1) Media feed direction

Set the sensor type to detect the print position according to the media to be used.

Set the sensor type according to the following procedure:

1. Press the  button in Online mode.



The product changes to Offline mode.

2. Press the  button.



The product changes to Settings mode.

3. Select [Printing] using the  /  buttons.

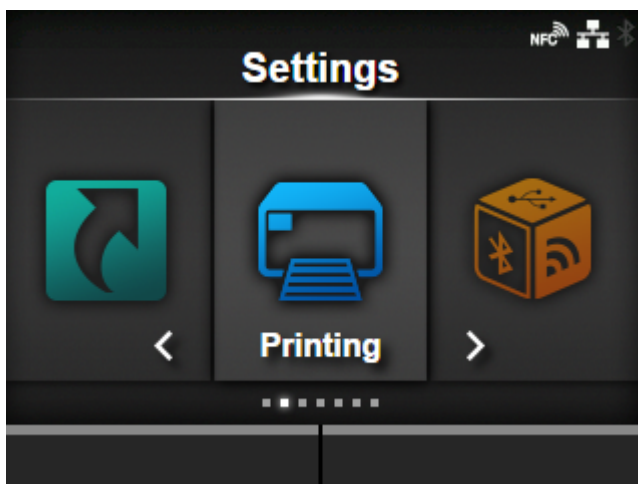

4. Press the  button.

The item list appears.



5. Select [Sensor Type] using the ▲ / ▼ buttons.

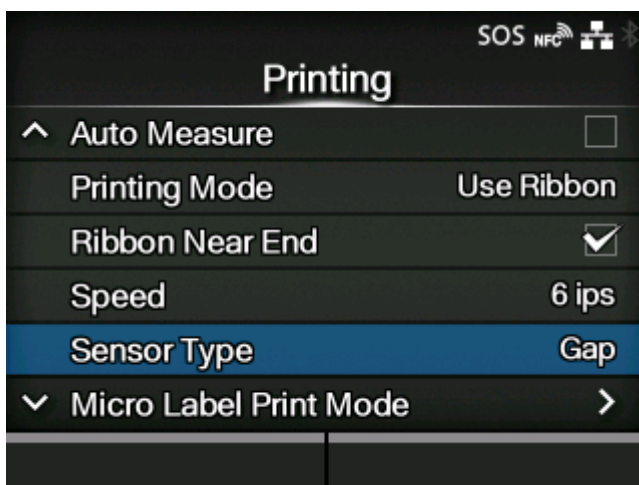

6. Press the ← button.

The [Sensor Type] screen appears.

7. Select the sensor type to detect the print position using the ▲ / ▼ buttons.

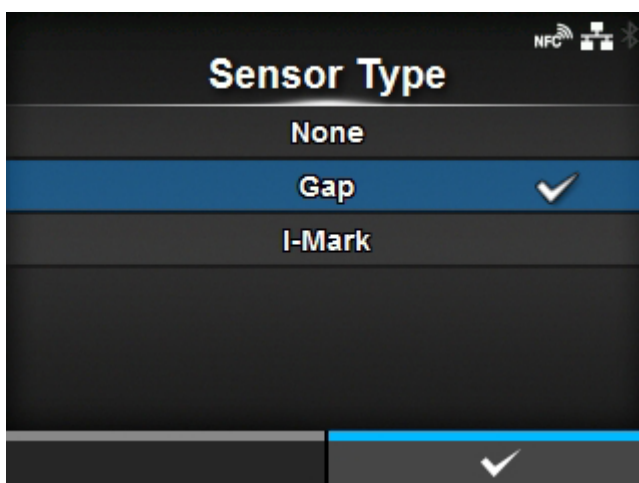

[None]

Disables the media sensor.

[Gap]

Select when using gap type media. Use the transmissive type sensor.

[I-Mark]

Select when using I-mark type media. Use the reflective type sensor.



- If you have selected [Tear-Off], [Dispenser], or [Cut & Print] in the [Print Mode] menu, only [Gap] and [I-Mark] will be available.
- If you have selected [Linerless] in the [Print Mode] menu (CL4NX Plus only), only [None] and [I-Mark] will be available.

8. Press the  button to confirm.

Print Mode

You can change the print mode of the product according to its usage and installed options.

The product has the following print modes:

[Continuous]

Prints the specified number of media. The media remains in position for printing at all times.

[Tear-Off] (Feeding media to the position for manual cutting)

After printing the specified number of media, the product feeds the last printed media so that it is fully extended out of the product's front for removal. After printing, tear off the media manually. The media will be back to the print head position to start the next printing.

[Cutter]

Cuts each media while printing the specified number of media. You can specify this option if you have installed the cutter unit or the rotary cutter unit.

[Cut & Print]

Allows you to continuously print and cut at the specified media repeat. If no print data is received within the period specified for [Eject Cut], the product will feed the media to the cut position and cut the last printed media. Media errors do not occur when using cut & print mode. You can specify this option if you have installed the cutter unit or the rotary cutter unit.

[Dispenser]

Peels the liner from the printed label as the label is fed to the product's front. Once the printed label has been removed from the product for application, the next label will retract and position itself for printing. You can specify this option if you have installed the dispenser unit.

[Linerless] (CL4NX Plus only)

Cuts each label while printing the specified number of labels. You can specify this option if you have installed the linerless cutter kit.



- You cannot set the [Print Mode] if [Auto-mode] is [Enabled].
-

Change the print mode according to the following procedure:

1. Press the  button in Online mode.



The product changes to Offline mode.

2. Press the  button.



The product changes to Settings mode.

3. Select [Printing] using the  /  buttons.

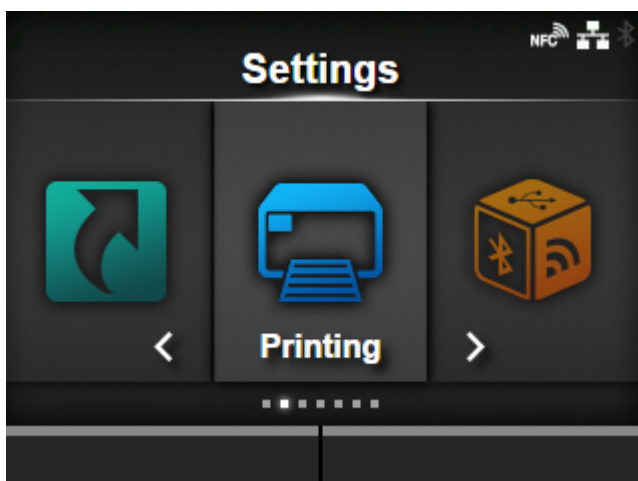

4. Press the  button.

The item list appears.



5. Select [Print Mode] using the  /  buttons.

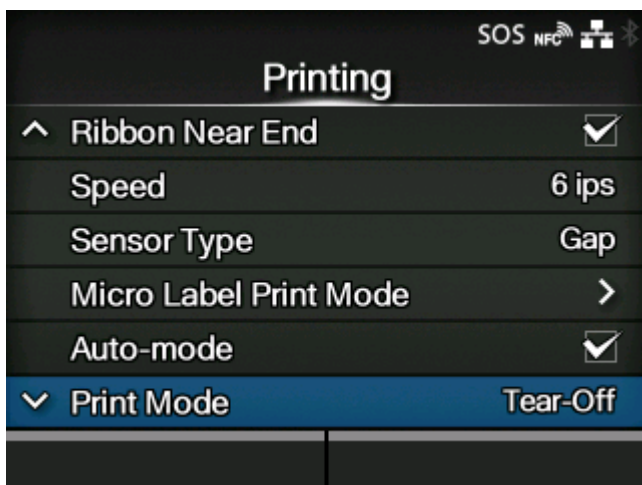

6. Press the  button.

The [Print Mode] screen appears.

7. Select the print mode using the ▲ / ▼ buttons.

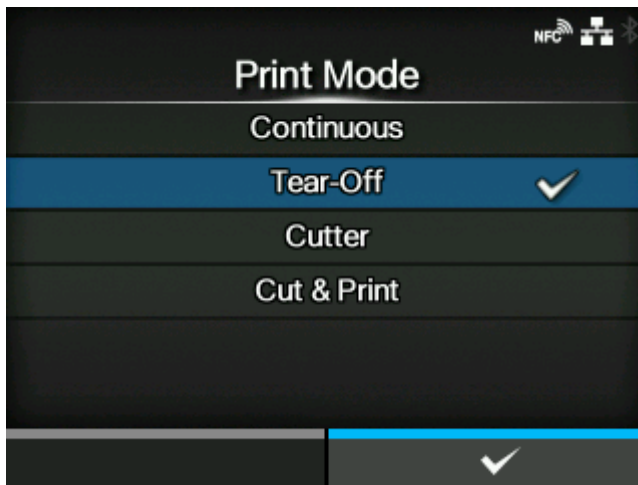

- Do not select Linerless Mode to use RFID tags on an RFID model. If you set Linerless Mode, you cannot use RFID tags.



- If no option is installed, [Continuous] and [Tear-Off] are available.
- If the optional cutter unit is installed, [Continuous], [Tear-Off], [Cutter], and [Cut & Print] are available.
- If the optional rotary cutter unit is installed to CL4NX Plus, [Cutter] and [Cut & Print] are available.
- If the optional dispenser unit is installed, [Continuous], [Tear-Off], and [Dispenser] are available.
- If the optional linerless cutter kit is installed to CL4NX Plus, only [Linerless] is available.

8. Press the  button to confirm.

Connecting the Product to a Computer

This section explains how to connect the product to a computer, and how to install the printer driver and the All-In-One Tool.

Procedure for Connecting the Product to a Computer

The product supports various interfaces and can be connected to a computer in an optimum way for your environment. When you have installed the printer driver to the computer, the data created with the computer (documents and illustrations) can be printed to a label through easy operations.

Also, you can print by sending a command directly to the product.

The product can be connected to a computer in the following way.

1. [Connecting Interfaces](#)



2. [Configuring the Interface Settings](#)

Set the product's interface from the Settings menu, which can be accessed from the product's display or the web configuration page.

Also, the settings can be done from the All-In-One Tool.

- When you connect them with a LAN or wireless LAN interfaces, configure the communication conditions, such as the IP address of the product.
- When you connect them with other interfaces, configure the communication conditions when needed to adapt to the computer to which you are connecting.
- To use the printer driver, the communication protocol must be set to Status4. (The initial value for the communication protocol for the product's interfaces is Status4.)



3. [Installing the Printer Driver](#) (Unnecessary when using commands)



- Use barcode fonts to create a barcode. Sometimes the barcode may not be read by a scanner if it is created with tools for creating images (such as BMP) and printed from this product. Because the tools create the barcode as an image only, the barcode may not be the correct data. Therefore, if the barcode cannot be read by a scanner, it is not a failure of the product or printer driver. Note that reading of the barcode is not guaranteed if it is created by such tools.
- The head check is just for a reference to check a broken element of the print head, and it is not a function to guarantee barcode readability. A regular barcode reader test is required.

Connecting Interfaces

Available Interfaces

The product supports the following interfaces.



- A product connected with multiple interface cables can continue to operate when receiving data. However, you cannot receive data from more than one interface at a time. Normally, do not use multiple interfaces at a time.
- The product prints the received data in order of reception. The next received data is stored in the receive buffer while the first data is printed.

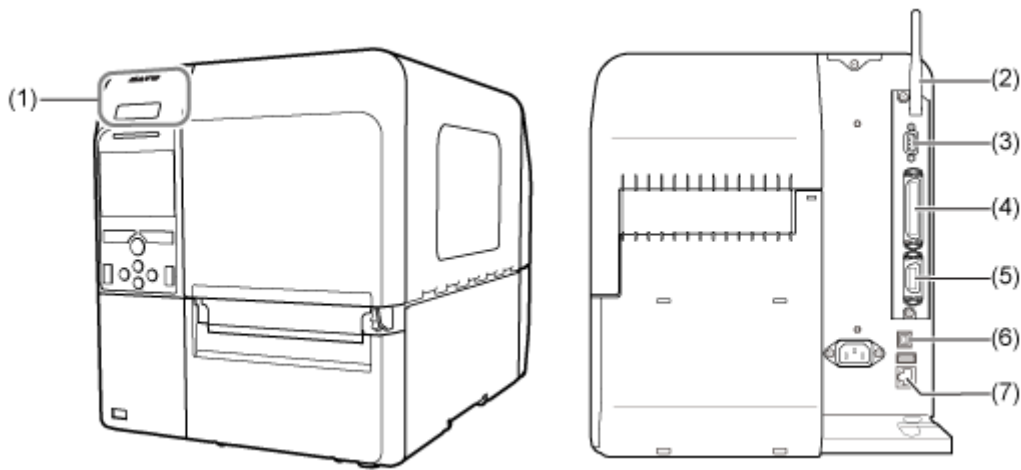

(1) NFC

(2) Wireless LAN

(3) RS-232C

(4) IEEE1284

(5) External signal (EXT)

(6) USB

(7) LAN

- Bluetooth



- The wireless LAN interface is optional.
- The NFC interface supports the handover function that simplifies the Bluetooth/Wi-Fi connection setup with Android devices. In addition, the NFC interface can be used for changing product settings with an Android device while the product is powered off and the power cord is not connected.



- Do not connect or disconnect the interface cables (or use a switch box) while power is supplied to either the product or computer. This may cause damage to the interface circuitry in the product or computer and is not covered by warranty.
-

USB Interface Connection (Standard)

Connect the interface cable when the product is powered off.

Connect the USB cable to the USB connector (Type B) (1) of the product.

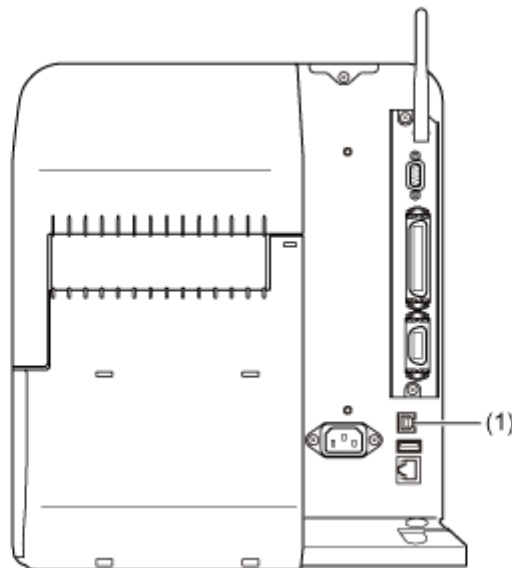

The USB interface is selected after connecting the USB cable to the computer and the product, and powering on the product while the computer is turned on.



- If the product is powered on without installing the printer driver, Windows' Plug & Play runs. When using the printer driver, do not power on the product while the USB cable is connected until instructed in the procedure for installing the printer driver.
 - We recommend a USB cable that is less than 2 m (6.6 feet) long.
-

LAN Interface Connection (Standard)

Connect the interface cable when the product is powered off.

Connect the LAN cable to the LAN connector (1) on the product.

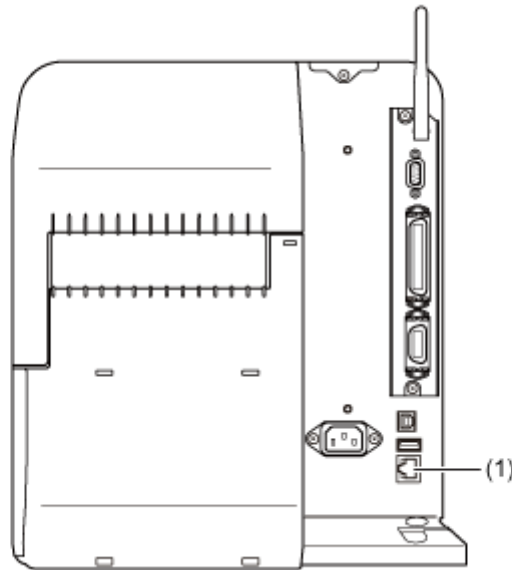

The communication condition settings must be configured according to your network environment. Set the IP address of the product.

The IP address of the product can be set through the product's [Interface] menu or the All-In-One Tool.



- To use the printer driver, the communication protocol must be set to Status4. (The initial value of the communication protocol for the product's LAN interface is Status4 ENQ.)

Bluetooth Interface Connection (Standard)

Wireless communications is possible with Bluetooth-compatible computers that are placed within about 10 m (32.8 feet) of the product.

Make sure that the Bluetooth function of the product and the computer are enabled, and then add the product as a Bluetooth device on the computer.

The product's Bluetooth function is enabled by default and can be configured from the [Interface] menu or the All-In-One Tool.



- Bluetooth connection may be unstable depending on a module spec or version of Bluetooth. When using Bluetooth connection, please test the operation beforehand in your usage environment (computer, print data, print quantity, print frequency, etc.).



- To use the printer driver, the communication protocol must be set to Status4. (The initial value of the communication protocol for the product's Bluetooth interface is Status4 Multi.)

NFC Interface Connection (Standard)

The NFC interface of the product supports a handover function that simplifies the Bluetooth/Wi-Fi connection setup with Android devices.

The handover function only performs the connection setup, such as the pairing and authentication with NFC, and passes the actual interface to the more advanced Bluetooth and Wi-Fi when communicating between NFC supported devices.

In general, the pairing and authentication require some procedures to enter authentication information, but the connection can be completed simply by holding the Android devices over the product while using NFC.

Touch the NFC antenna (1) of the product with the NFC mark on the Android device.

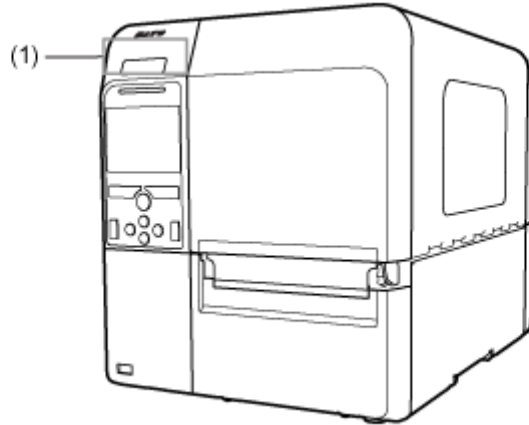

- If it does not communicate well, shift the Android device to the front, back, left and right, and then hold it up again.
- For the operation of the NFC for the Android device, refer to the user manual for the Android device.

RS-232C Interface Connection (Standard)

Connect the interface cable when the product is powered off.

Connect the RS-232C cable to the RS-232C connector (1).

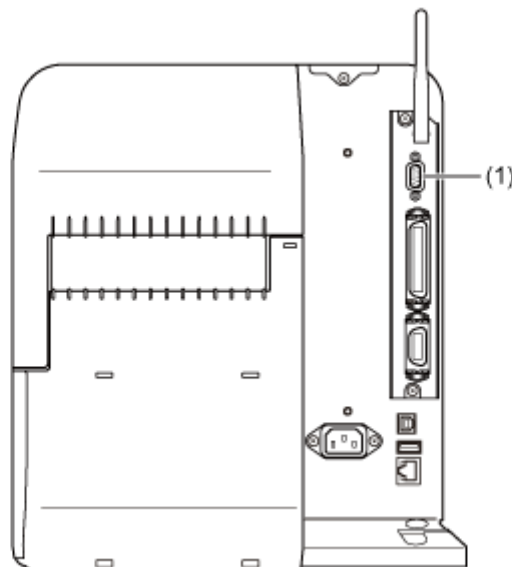

Configure the interface settings of the product according to the interface settings of the computer.

The communication conditions of the RS-232C interface can be set through the product's [Interface] menu or the All-In-One Tool.



- To use the RS-232C interface to connect with the computer, the product's [Tools] > [Barcode Checker] > [Test] > [Interface] menu must be set to [RS-232C].
- The interface settings of the computer can be confirmed by the following. In the Device Manager, right-click [Ports (COM & LPT)] > [Communications Port (COM1)] and select [Properties]. Then, check the [Port Settings] tab of the displayed Properties screen.
- For the RS-232C cable, note that the connection cable varies according to the communication protocol setting. If you use the wrong cable, it will not operate correctly.
- If the communication settings differ between the computer and product, it will not operate correctly. A communication error will be detected.
- To use the printer driver, the communication protocol must be set to Status4. (The initial value for the communication protocol for the product's RS-232C interface is Status4.)
- Be sure to use the recommended RS-232C cable.
- Printing using the USB serial conversion cable is not guaranteed. Also, no support for the connection procedure is provided.

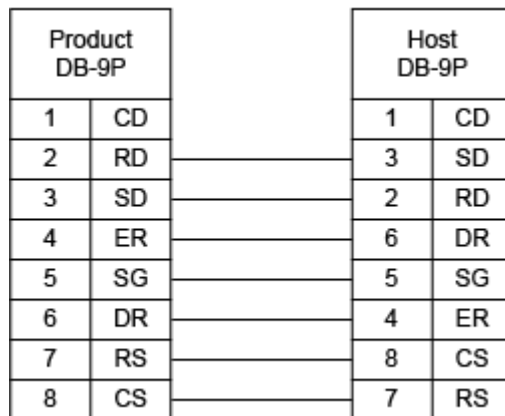

IEEE1284 Interface Connection (Standard)

Connect the interface cable when the product is powered off.

Connect the IEEE1284-compliant cable to the IEEE1284 connector (1) of the product.

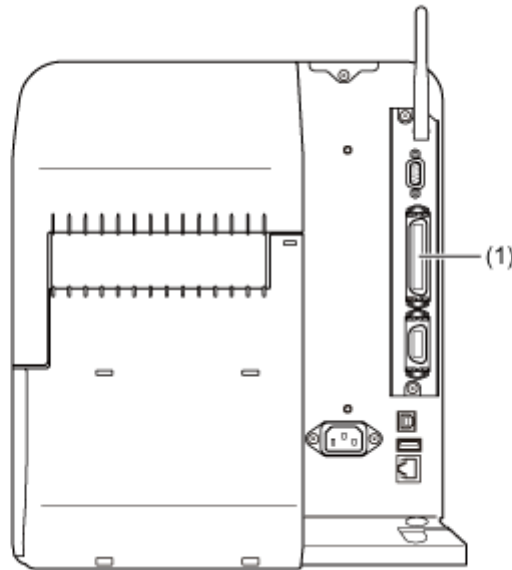

- If the product is powered on without installing the printer driver, Windows' Plug & Play runs. When you use the printer driver, do not power on the product while the cable is connected, until instructed in the procedure for installing the printer driver.
- Be sure to use the recommended IEEE1284-compliant cable. If you use cables other than the IEEE1284-compliant cable, your data may become corrupt.
- IEEE1284-compliant: compatible mode, ECP mode, and nibble mode are supported.
- Some computers may not support ECP mode.
- ECP mode is configured in the BIOS settings of the computer. Some computers may use the software tools for Windows.
- Some computer models may not perform ECP operations even if they are set to ECP mode. Contact the computer manufacturer.
- Printing using the USB parallel conversion cable is not guaranteed. Also, no support for the connection procedure is provided.

Wireless LAN Interface Connection (Optional)

Check if the wireless LAN antenna (1) is attached to the product.

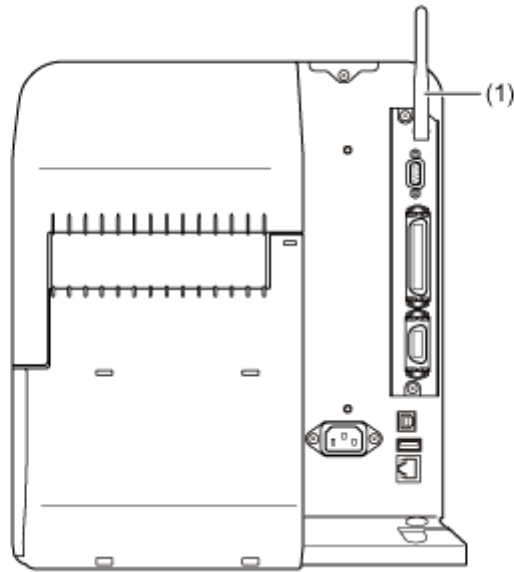

The printer driver performs data communication using the dedicated SOCKET interfaces.

The communication condition settings must be configured according to your network environment. Set the IP address of the product.

The IP address of the product can be set through the product's [Interface] menu or the All-In-One Tool.



- To use the printer driver, the communication protocol must be set to Status4. (The initial value of the communication protocol for the product's wireless LAN interface is Status4 ENQ.)
- The product does not support Atheros, SuperG, or XR functions.

Configuring the Interface Settings

Interface Setting Methods

Configure the interface settings of the product according to the communication conditions of the connected network and computer.

You can set the interface settings of the product doing either of the following.

- Set from the Settings mode of the product
- Set using the All-In-One Tool from the computer

Configuring the Interface Settings from the Interface Menu of the Product

Configure the settings related to the interfaces from the [Interface] menu in the Settings mode of the product.

1. Press the  button in Online mode.



The product changes to Offline mode.

2. Press the  button.



The product changes to Settings mode.

3. Select [Interface] using the  /  buttons.

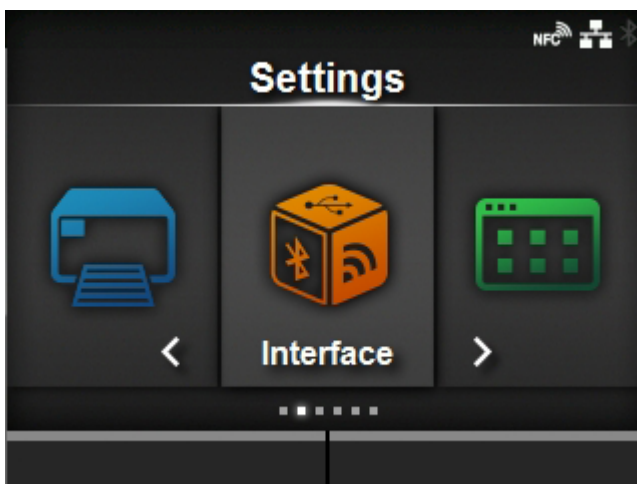

4. Press the  button.

The item list appears.

5. Select the interface using the ▲ / ▼ buttons.

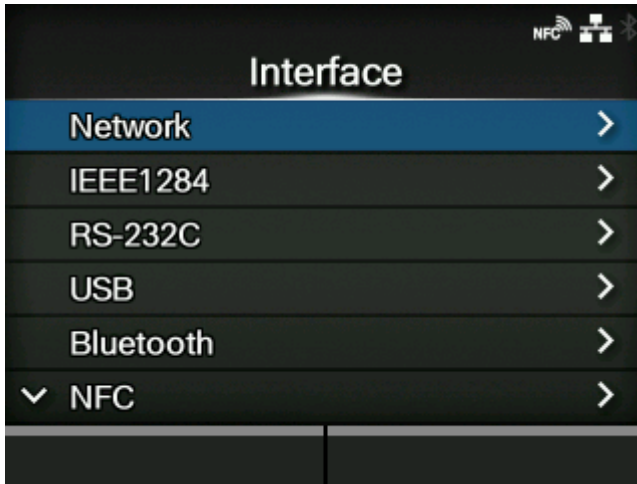

[Network]

Sets the LAN connection and wireless LAN connection.

[IEEE1284]

Sets the IEEE1284 connection.

Appears only if the combo interface board is installed.

[RS-232C]

Sets the RS-232C connection.

Appears only if the combo interface board is installed.

[USB]

Sets the USB connection.

[Bluetooth]

Sets the Bluetooth connection.

[NFC]

Sets the NFC connection.

[Ignore CR/LF]

Sets to ignore CR/LF codes.

[Ignore CAN/DLE]

Sets to ignore CAN/DLE codes.

[External I/O]

Sets the external signal (EXT).

Appears only if the combo interface board is installed.

[RFID] (RFID models only)

Sets the RFID.

Appears only for the RFID model.

6. Press the  button.

The settings items of the selected interface appear.

Change the settings according to the communication conditions of the connected network and computer.

Configuring the Interface Settings Using the All-In-One Tool

Installing the All-In-One Tool

When you use the All-In-One Tool, you can easily set and manage the product.

Download the All-In-One Tool and All-In-One Tool Manual from your local SATO website <https://www.sato-global.com/drivers/redirect.html>, and install the software to a computer. For the compatible OS, refer to the "System Requirements" section of the All-In-One Tool Manual.

Installing the Printer Driver

The printer driver is software that can send data created on the computer (documents and illustrations) to the product and print it to a label.

Download and use the printer driver from your local SATO website <https://www.sato-global.com/drivers/redirect.html>.

From the same site, you can download and refer to the Printer Driver Manual for details regarding how to install and the functions of the printer driver.

All-In-One Tool Features

When you add the product to the All-In-One Tool, you can easily set and manage the product.



- For details of the All-In-One Tool, download and read the All-In-One Tool Manual from your local SATO website. <https://www.sato-global.com/drivers/redirect.html>
-

Loading Media and Ribbon

Media, Ribbon and Print Methods

The product supports two types of print methods, thermal transfer and direct thermal.

The media or ribbon to be used varies depending on the print method.

Thermal transfer

Prints using a ribbon.

Direct thermal

Prints using direct thermal media.



- Ribbon is not necessary if you are using direct thermal media.
-

Loading Media

Usable Media

The product can print on the following two types of media.

- Media roll
- Fan-fold media

The product uses media sensors to detect I-marks or gaps on the media in order to precisely print the content.

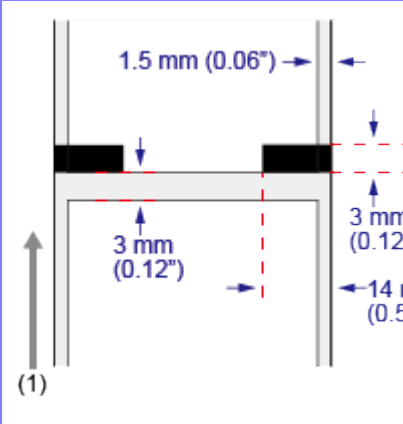
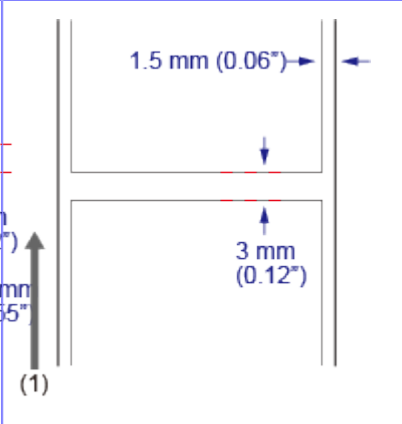
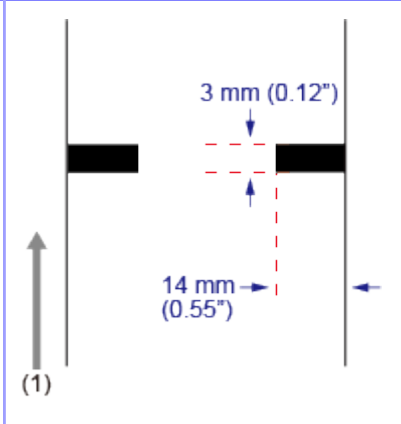
I-mark label	Gap label	I-mark journal paper/ linerless label (CL4NX Plus only)
		



(1) Media feed direction

Adjusting the Position of the Media Sensor

When you use nonstandard media (for example, media with printing on the underside, or media with a special shape), the media sensor cannot detect the I-mark or gap of the media correctly. In such a case, adjust the position of the media sensor to detect the I-mark or gap correctly.

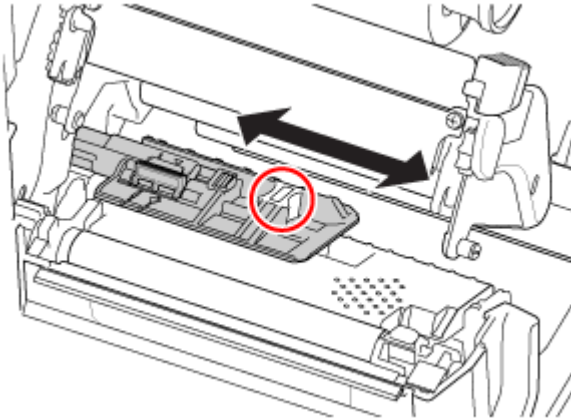
- **Adjust the media sensor guide to the position where it can detect the I-mark or gap of the media.**



- **The I-mark sensor (reflective type) is below the  mark, and the Gap sensor (transmissive type) is below the  mark.**

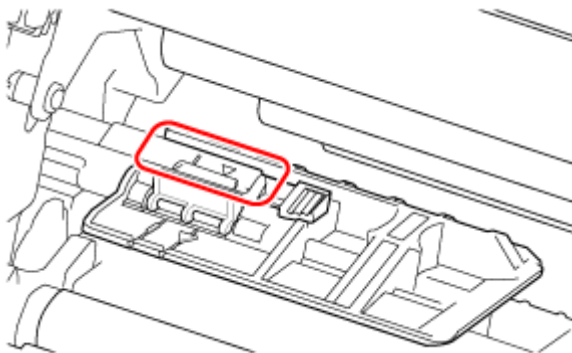

Loading the Media

Precautions for Loading the Media

Use our specified supply products for the product, for optimum print quality.



- The print head and its surroundings are hot after printing. Be careful not to get burned.
 - Touching the edge of the print head with your bare hand could cause injury.
-



- The usable media sizes and print quality depends conditions such as print speed, media, media/ribbon combination, product settings and used environment. It is highly recommended to check the performance based on actual usage conditions in advance.
-

Loading the Media Roll



- The routing path of the media is shown in the below picture.

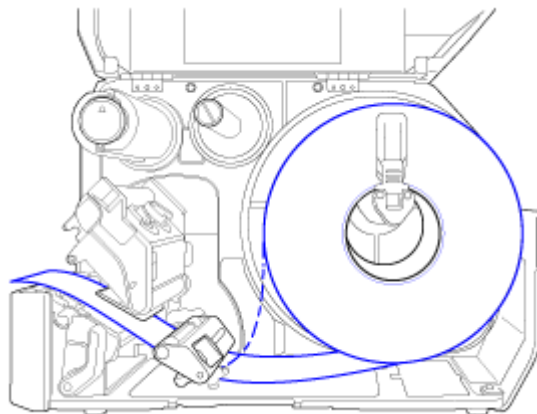

—
Face-in media

- - -
Face-out media

1. Open the top cover (1).



- Open the top cover fully to prevent accidental drop of the cover.

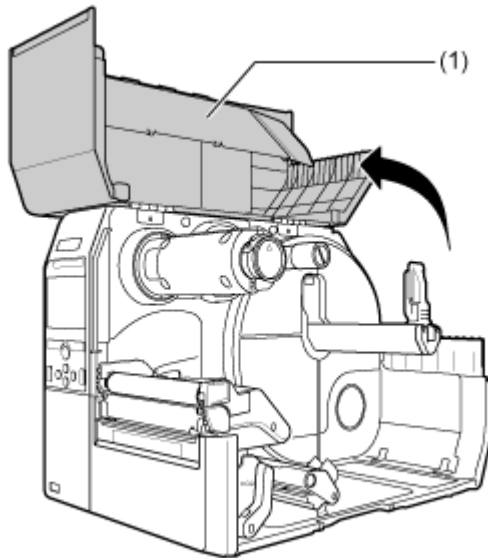

2. Push the head lock lever (2) towards the rear.

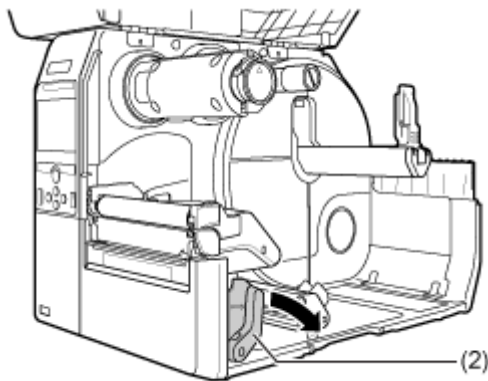

3. Pull the media holder guide (3) and media guide (4) away from the product.

Turn the knob (5) counterclockwise to release the media guide.

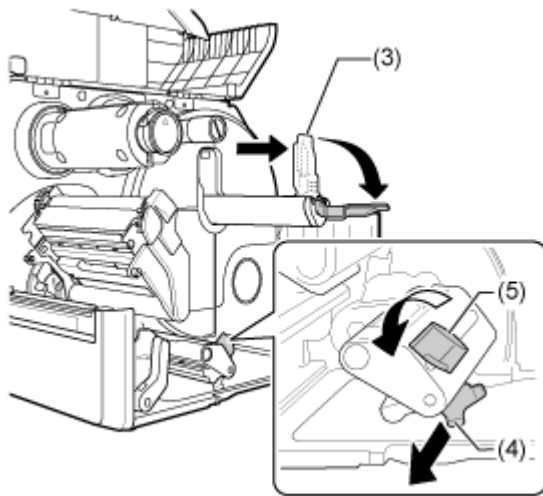

4. Load the media in the media holder (6).

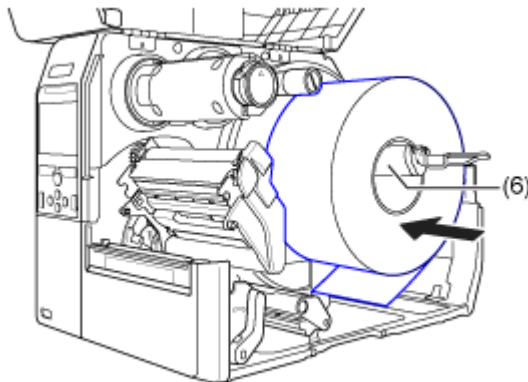

Make sure that the media roll is all the way in towards the inside of the product.

5. Push the media holder guide (3) lightly against the media roll.

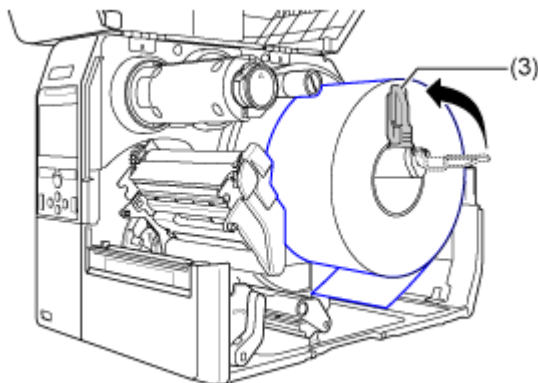

6. Pass the media below the media damper (7) and the media sensor guide (8) while pushing the media to inside of the product.

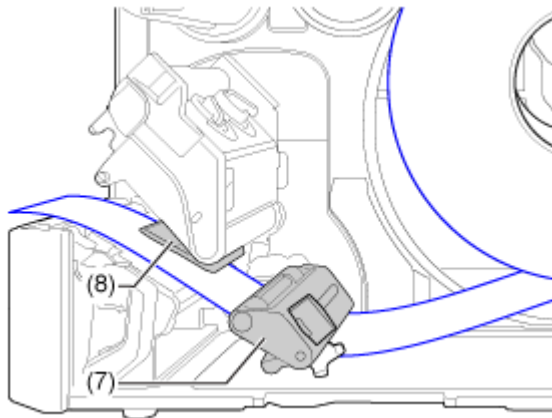

Make sure that the end of the media extends out the front of the product.

7. Press the print head down until the head lock lever is locked.

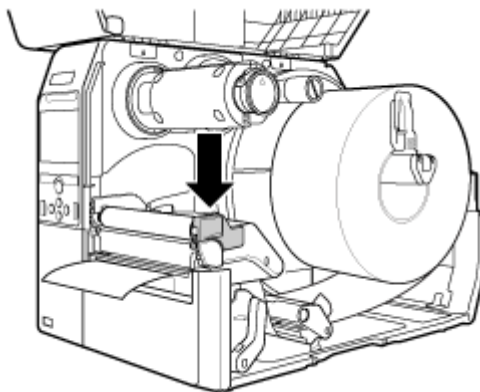

8. Press the media guide (4) lightly against the end of the media, and turn the knob (5) to lock the media guide.

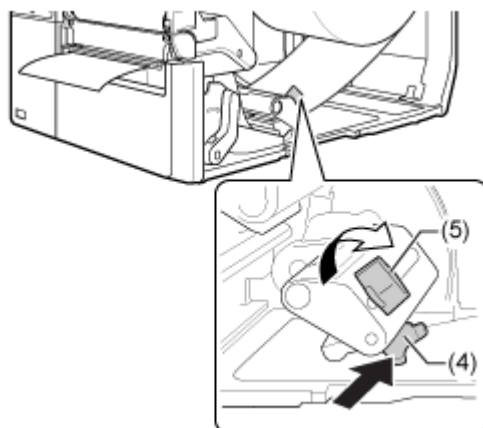

9. Close the top cover.



- When closing the top cover, be careful not to pinch your fingers.
-

10. Press the  button (FEED) in Offline mode to feed the media.

11. Press the  button (ONLINE) to change to Online mode.



- You need to load the ribbon when printing using thermal transfer.
-

Loading the Fan-fold Media

1. Open the top cover (1).



- Open the top cover fully to prevent accidental drop of the cover.
-

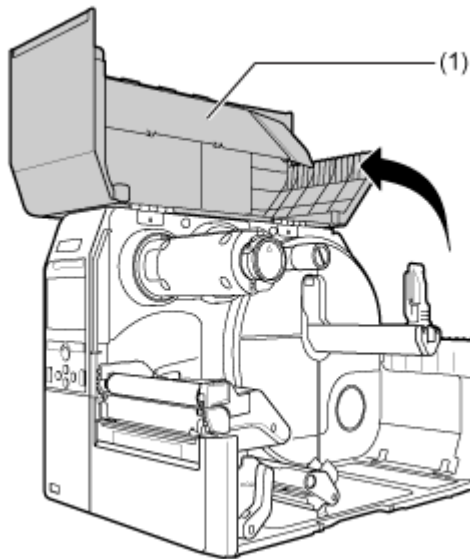

2. Push the head lock lever (2) towards the rear.

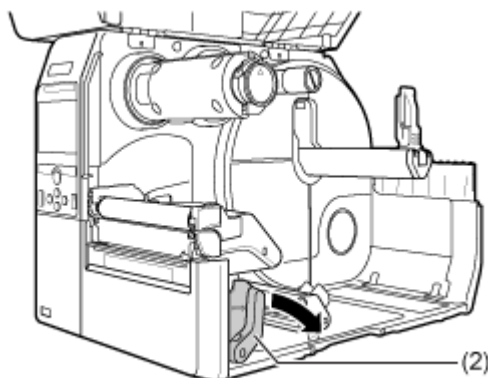

3. Place the fan-fold media on a flat location, and load the media from the media slot on the rear or the bottom of the product.

The routing path of the media is shown in the below picture.

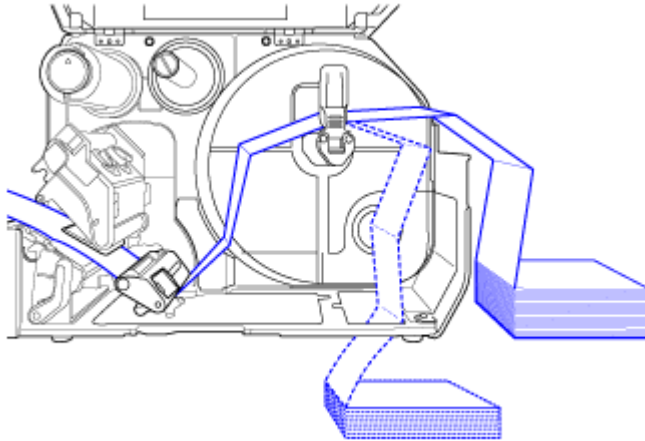

Load the media from the rear of the product

Load the media from the bottom of the product.



- When loading the media, make sure that the print side faces up.

-
4. After passing the media through the slot, refer to the same steps as the Media Roll to load the media.



- You need to load the ribbon when printing using thermal transfer.
- If a media jam frequently occurs with the media being loaded from the bottom of the product, change the load location to the rear of the product.

Loading the Media with the Optional Cutter Unit



- Be careful not to touch the cutter blade.

-
1. Open the top cover (1).



- Open the top cover fully to prevent accidental drop of the cover.
-

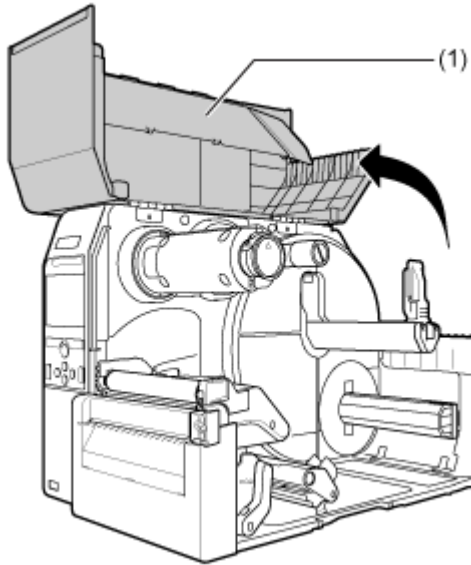

- 2. Push the head lock lever (2) towards the rear.**

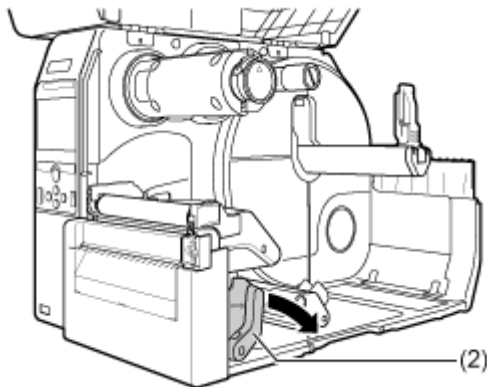

3. Pull the media holder guide (3) and media guide (4) away from the product.

Turn the knob (5) counterclockwise to release the media guide.

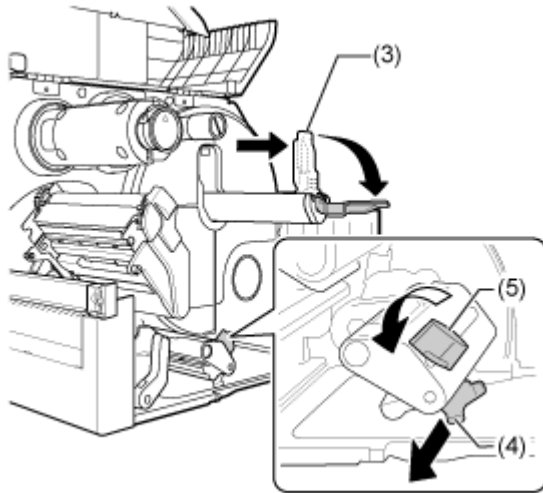

4. Load the media roll or the fan-fold media.

For Media Roll

The routing path of the media is shown in the below picture.

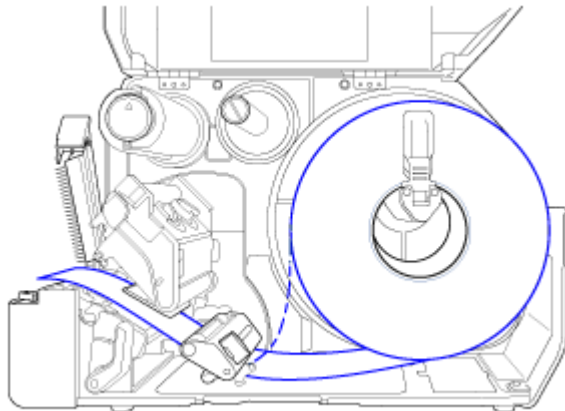

— Face-in media

- - - Face-out media

- a. Load the media in the media holder (6).

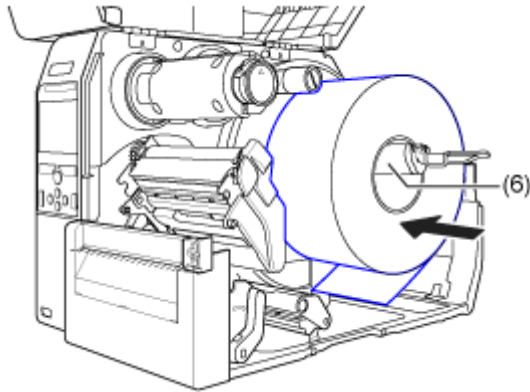

Make sure that the media roll is all the way in towards the inside of the product.

- b. Push the media holder guide (3) lightly against the media roll.

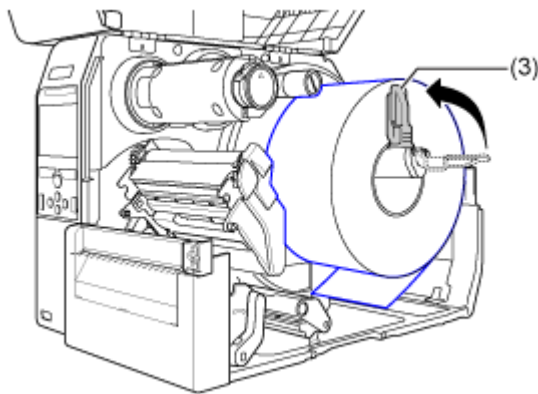

For Fan-fold Media

- a. Place the fan-fold media on a flat location, and then load the media from the rear of the product or from the media slot on the bottom of the product.

The routing path of the media is shown in the below picture.

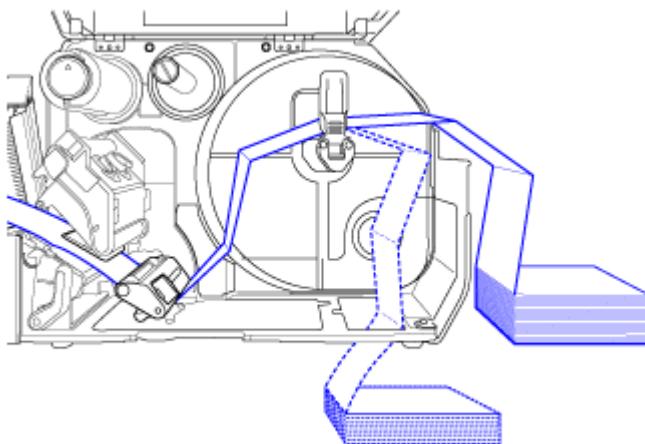

Load the media from the rear of the product

Load the media from the bottom of the product.



- When loading the media, make sure that the print side faces up.
-

- 5. Pull the tab (7) of the cutter unit in the direction A, and then open up the cutter-open lever to (B).**

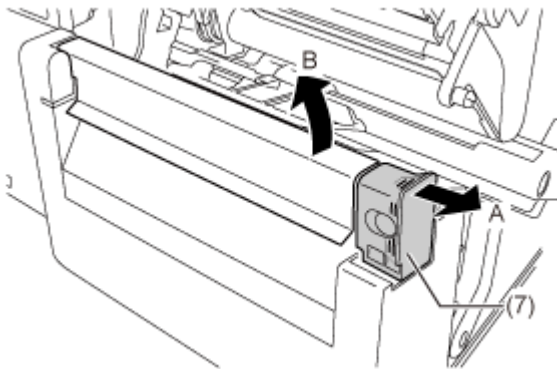

- 6. Pass the media below the media damper (8) and media sensor guide (9) and through the cutter unit while pushing the media to inside of the product.**

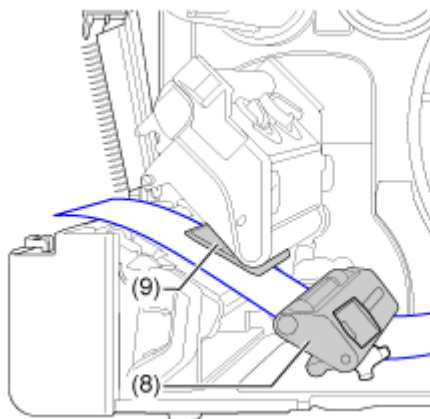

Make sure that the end of the media extends out the front of the product.

7. Press the print head down until the head lock lever is locked.

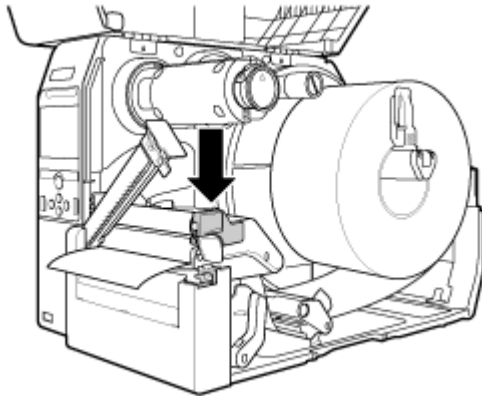

8. Close the cutter and then push the tab (7) in the reverse direction to lock it.

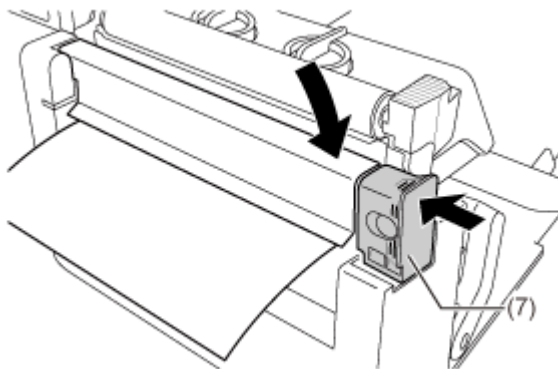

9. Press the media guide (4) lightly against the end of the media, and then turn the knob (5) to lock the media guide.

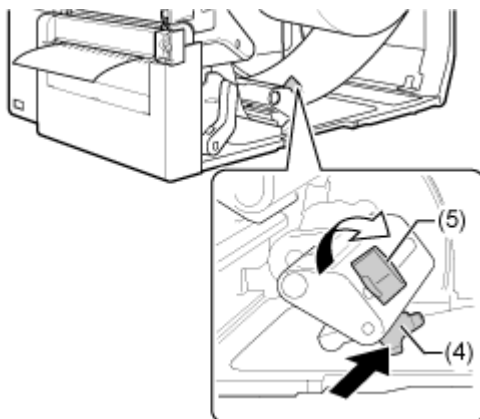

10. Close the top cover.



• When closing the top cover, be careful not to pinch your fingers.

11. Press the  button (FEED) in Offline mode to feed the media.

12. Press the  button (ONLINE) to change to Online mode.



- You need to load the ribbon when printing using thermal transfer.
-

Loading the Media with the Optional Rotary Cutter Unit (CL4NX Plus Only)



- Be careful not to touch the cutter blade.
-

1. Open the top cover (1).



- Open the top cover fully to prevent accidental drop of the cover.
-

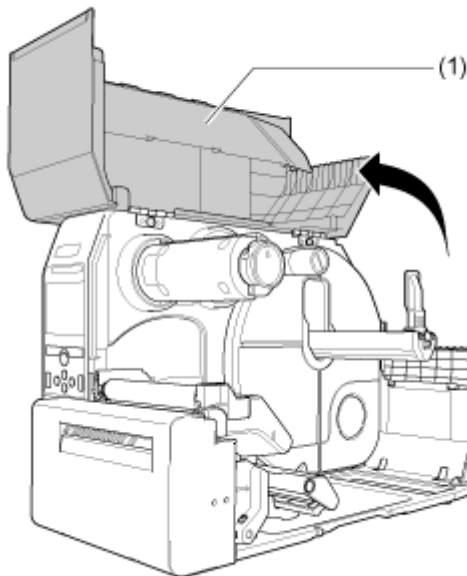

2. Push the head lock lever (2) towards the rear.

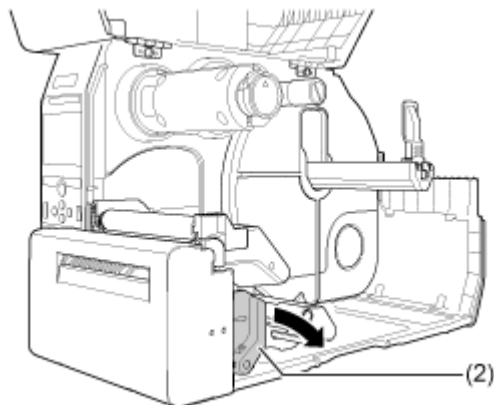

3. Pull the media holder guide (3) and media guide (4) away from the product.

Turn the knob (5) counterclockwise to release the media guide.

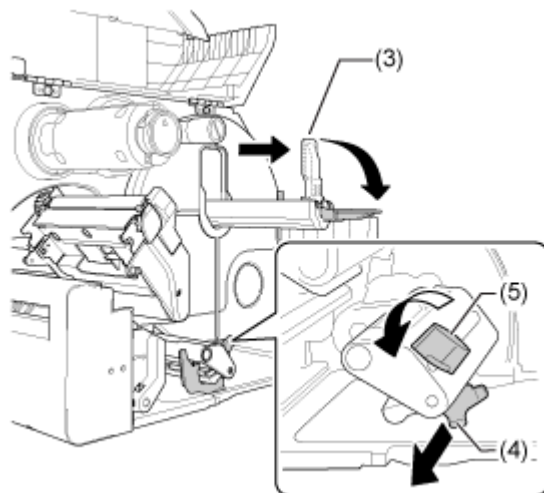

4. Load the media roll or the fan-fold media.

For Media Roll

The routing path of the media is shown in the below picture.

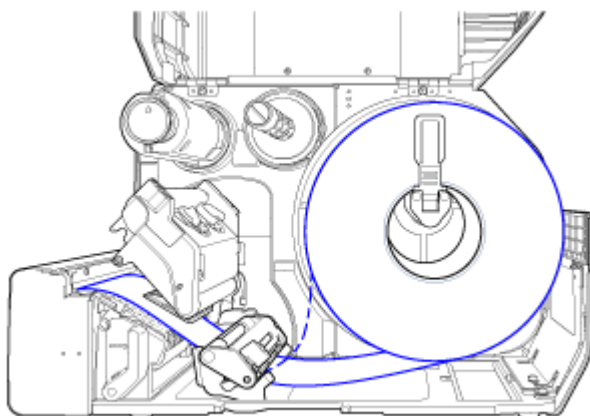

— Face-in media

- - - Face-out media

- a. Load the media in the media holder (6).

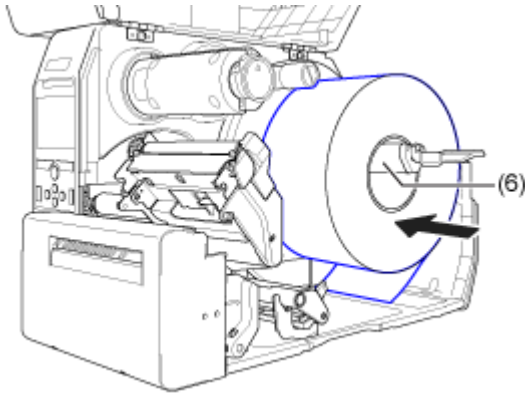

Make sure that the media roll is all the way in towards the inside of the product.

- b. Push the media holder guide (3) lightly against the media roll.

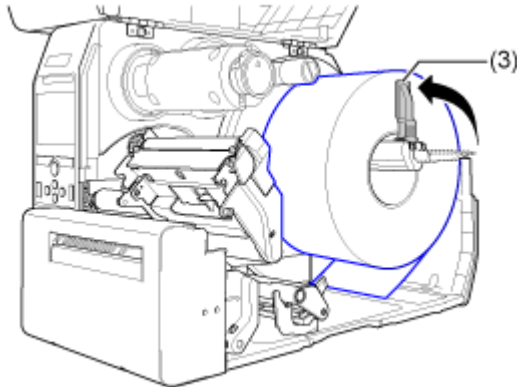

For Fan-fold Media

- a. Place the fan-fold media on a flat location, and then load the media from the rear of the product or from the media slot on the bottom of the product.

The routing path of the media is shown in the below picture.

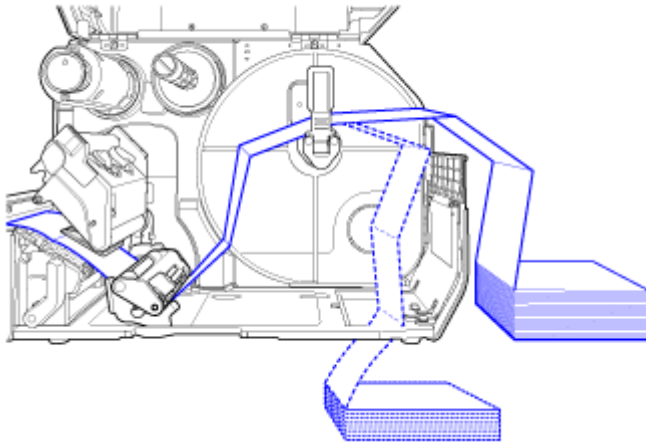

Load the media from the rear of the product.

Load the media from the bottom of the product.



- When loading the media, make sure that the print side faces up.
-

5. Pass the media below the media damper (7) and media sensor guide (8) while pushing the media to inside of the product.

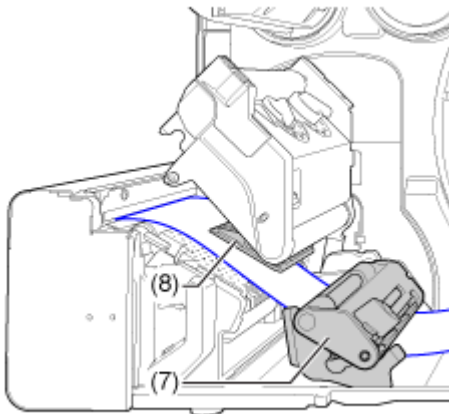

6. Insert the media from inside of the product into the media discharge outlet (9).

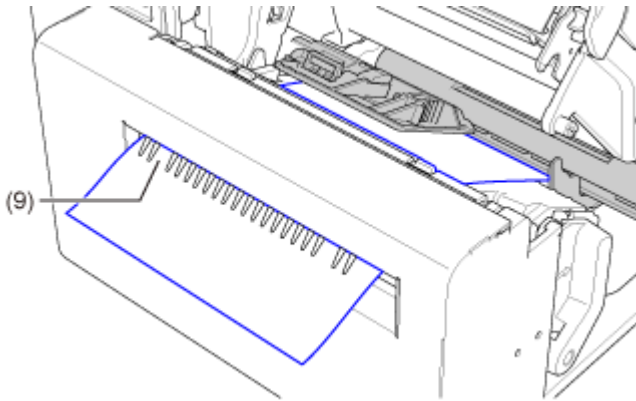

7. Press the print head down until the head lock lever is locked.

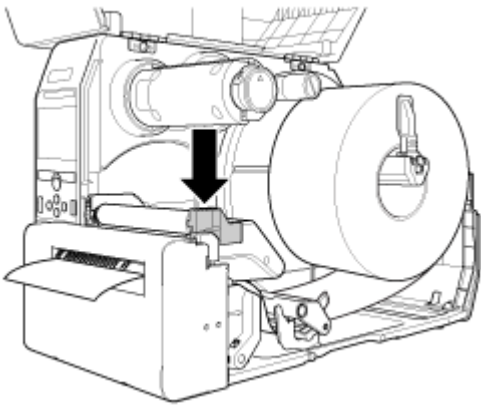

8. Press the media guide (4) lightly against the end of the media, and then turn the knob (5) to lock the media guide.

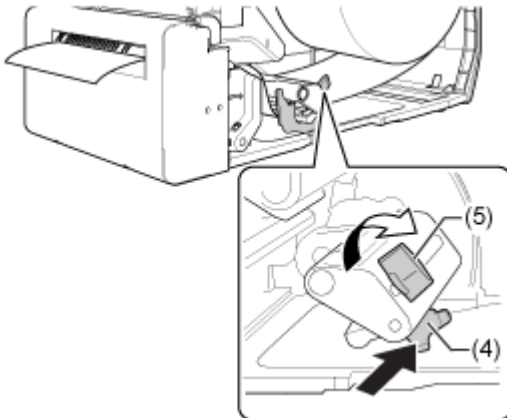

9. Close the top cover.



- When closing the top cover, be careful not to pinch your fingers.

10. Press the  button (FEED) in Offline mode to feed the media.

11. Press the  button (ONLINE) to change to Online mode.



- You need to load the ribbon when printing using thermal transfer.
-

Loading the Media with the Optional Dispenser Unit and Liner Discharge Outlet

The below topic describes the procedure to dispense the label and eject the liner out of the product.

1. Open the top cover (1).



- Open the top cover fully to prevent accidental drop of the cover.
-

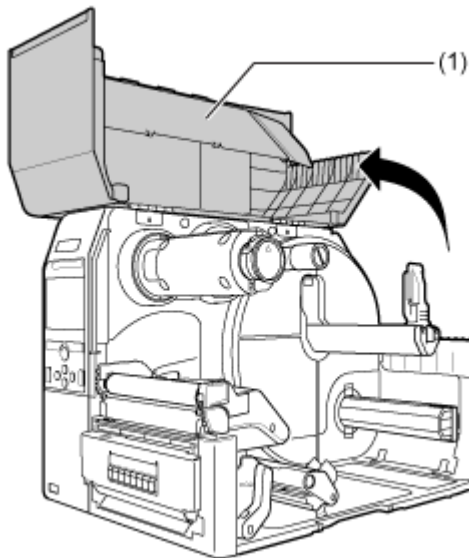

2. Push the head lock lever (2) towards the rear.

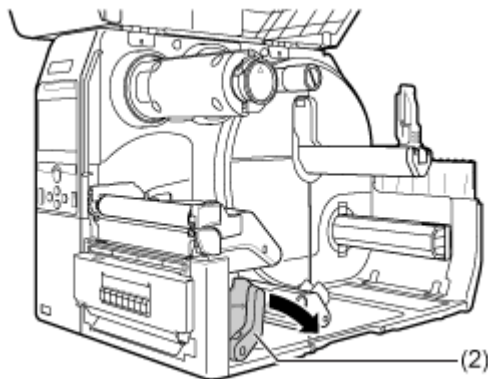

3. Pull the media holder guide (3) and media guide (4) away from the product.

Turn the knob (5) counterclockwise to release the media guide.

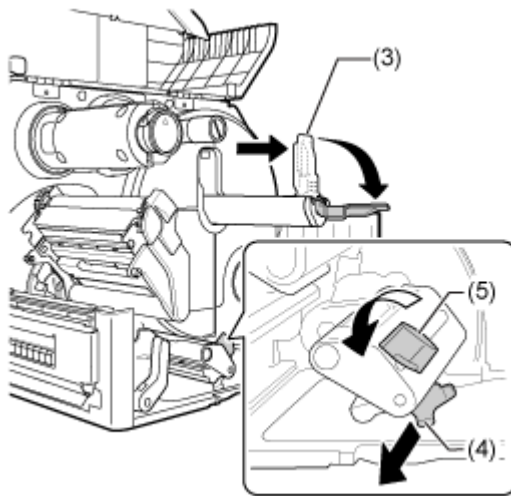

4. Load the media in the media holder (6).

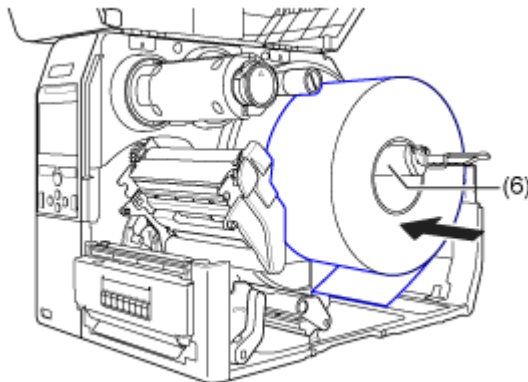

Make sure that the media roll is all the way in to inside of the product.

5. Push the media holder guide (3) lightly against the media roll.

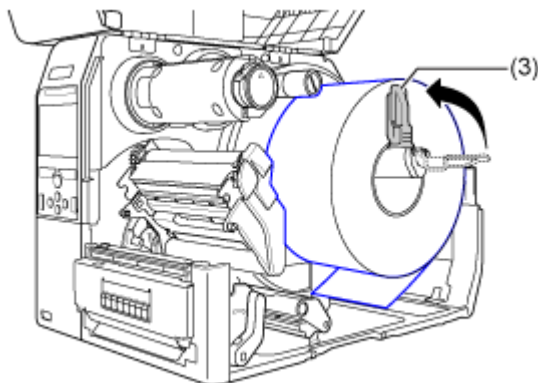

6. Pass the media below the media damper (7) and the media sensor guide (8) while pushing the media to inside of the product.

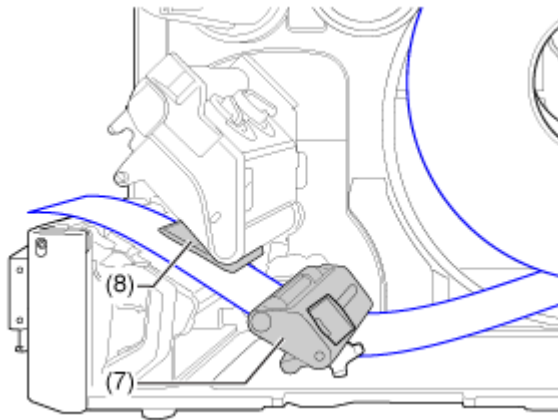

Make sure that the end of the media extends out the front of the product.

7. Press the tab (9) at the front of the product to open the dispenser unit (10).

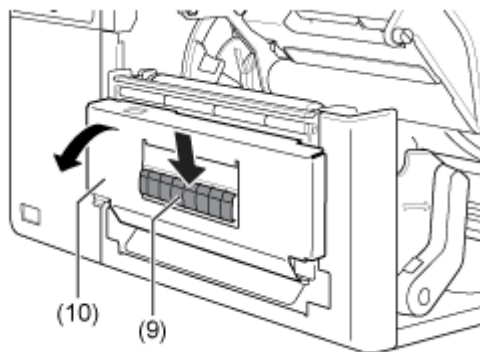

8. Remove about 30 cm (11.8") of labels (11) from the liner (12).

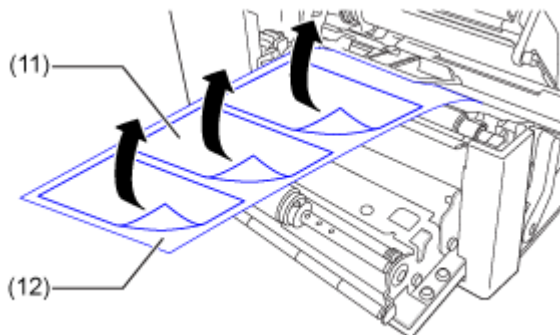

9. Pass the liner (12) through the gap of the dispenser unit to the outside of the product.

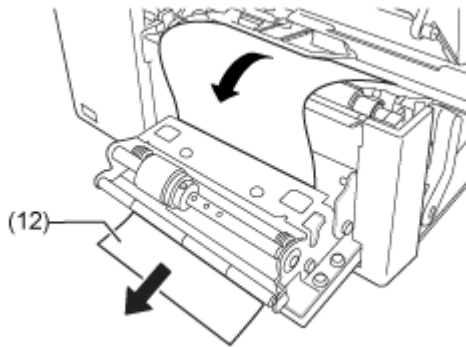

10. Adjust the dispenser roller (13) to the center of the label.

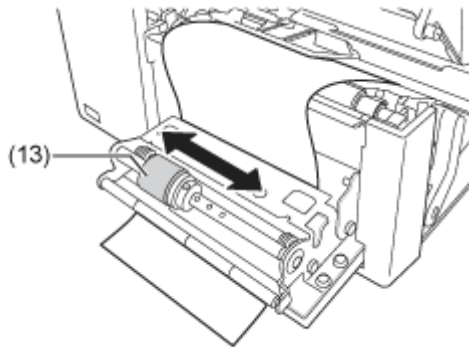

11. Close the print head.

12. Close the dispenser unit.

13. Press the media guide lightly against the end of the media, and then turn the knob to lock the media guide.

14. Close the top cover.



- When closing the top cover, be careful not to pinch your fingers.

15. Press the  button (FEED) in Offline mode to feed the media.

16. Press the  button (ONLINE) to change to Online mode.



- You need to load the ribbon when printing using thermal transfer.



- When not using the product for a long time, keep the dispenser unit open to protect the roller.

Loading the Media with the Optional Dispenser Unit and Liner Discharge Rewinder

The below topic describes the procedure to dispense the label and rewind the liner in the product.



- The maximum diameter of the liner that can be rewound in the product is $\varnothing 120$ mm (4.72").
- The routing path of the media is shown in the below picture.

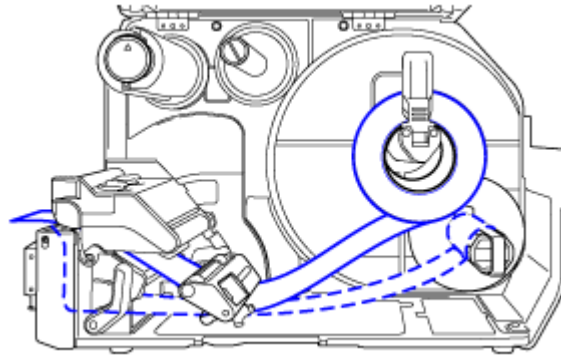

—————
Label

- - - - -
Liner

1. Open the top cover (1).



- Open the top cover fully to prevent accidental drop of the cover.

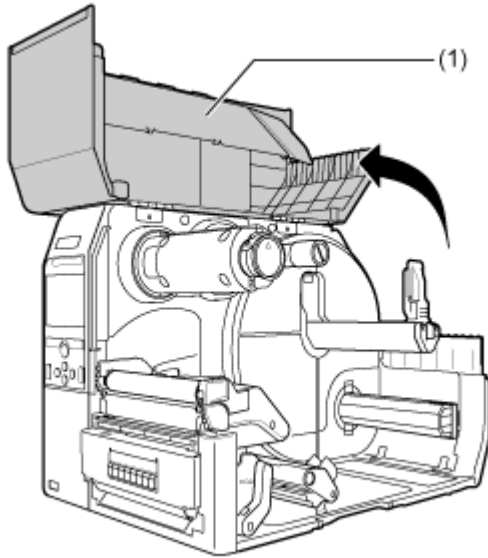

2. Push the head lock lever (2) towards the rear.

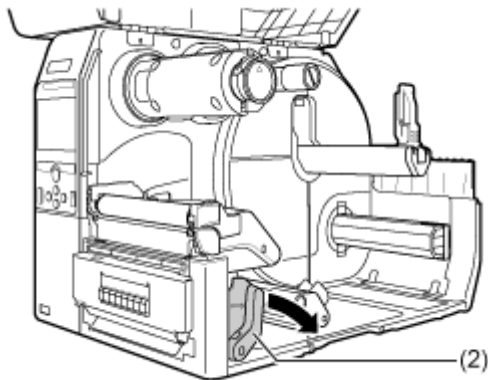

3. Pull the media holder guide (3) and media guide (4) away from the product.

Turn the knob (5) counterclockwise to release the media guide.

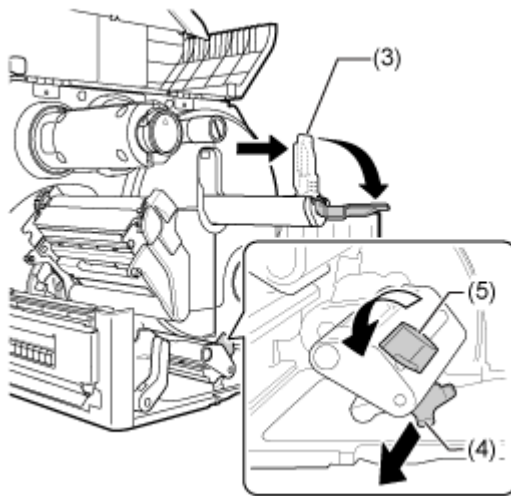

4. Load the media in the media holder (6).

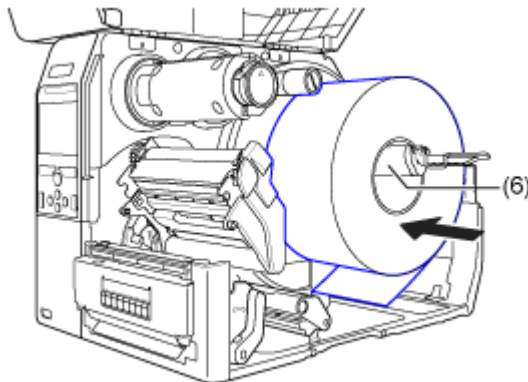

Make sure that the media roll is all the way in to inside of the product.

5. Push the media holder guide (3) lightly against the media roll.

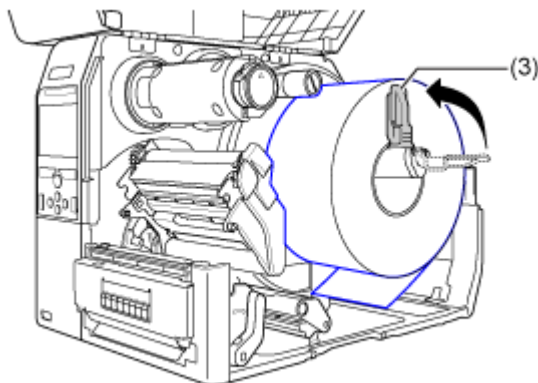

6. Pass the media below the media damper (7) and the media sensor guide (8) while pushing the media to inside of the product.

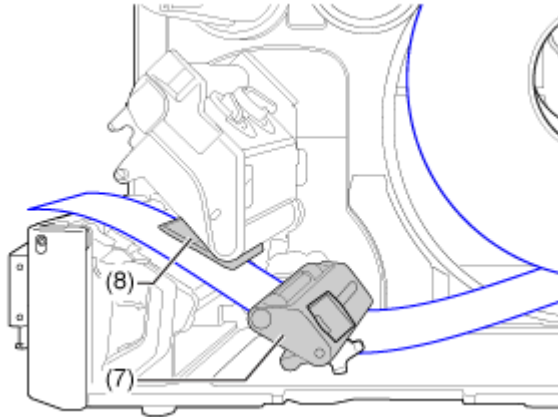

Make sure that the end of the media extends out the front of the product.

7. Press the tab (9) at the front of the product to open the dispenser unit (10).

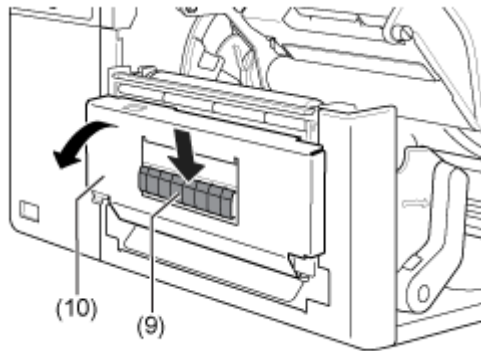

8. Remove about 80 cm (31.5") of labels (11) from the liner (12).

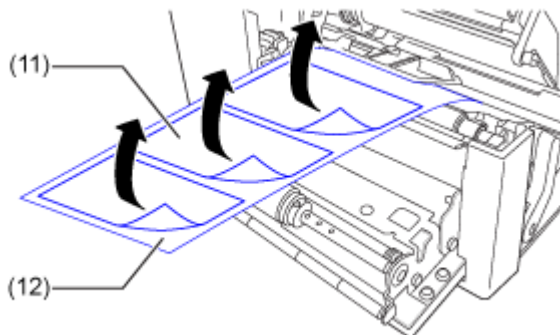

9. Pass the liner (12) through the gap of the dispenser unit to the inside of the product.

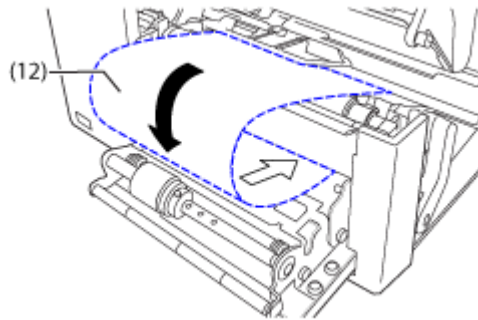

10. Adjust the dispenser roller (13) to the center of the label.

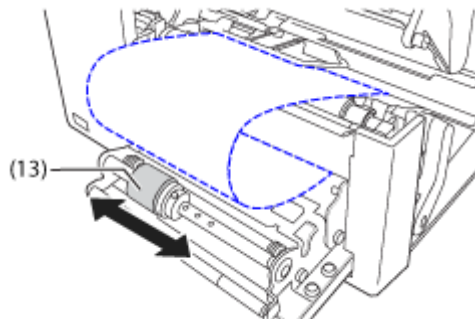

11. Pass the liner (12) below the liner rewriter (14), and attach it with the clip (15).

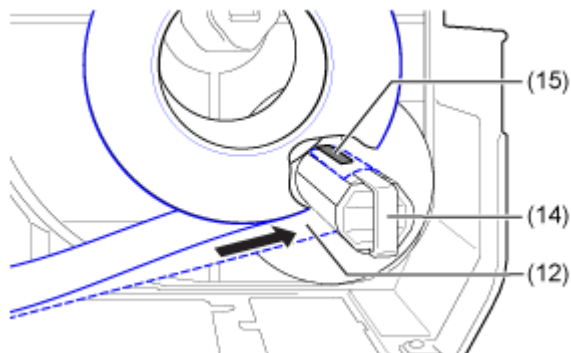

12. Rotate the liner rewriter (14) counterclockwise by hand, to wind the liner.

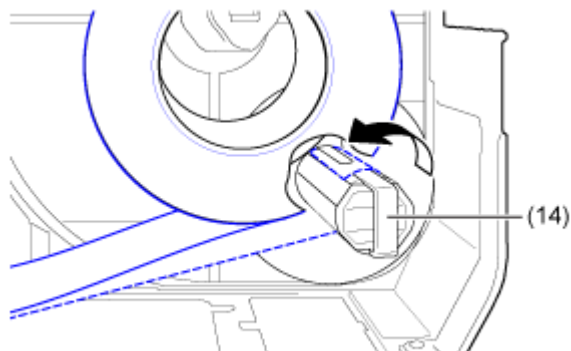

13. Close the print head.

14. Close the dispenser unit.

15. Press the media guide lightly against the end of the media, and then turn the knob to lock the media guide.

16. Close the top cover.



- When closing the top cover, be careful not to pinch your fingers.

17. Press the  button (FEED) in Offline mode to feed the media.

18. Press the  button (ONLINE) to change to Online mode.



- You need to load the ribbon when printing using thermal transfer.



- When not using the product for a long time, keep the dispenser unit open to protect the roller.

Removing the Liner from the Rewinder



- The rewriter can take up maximum a diameter of 120 mm (4.72") of liner.

1. Confirm that the liner (1) has been cut, pull the clip (2) towards you, and pull out the liner (1).

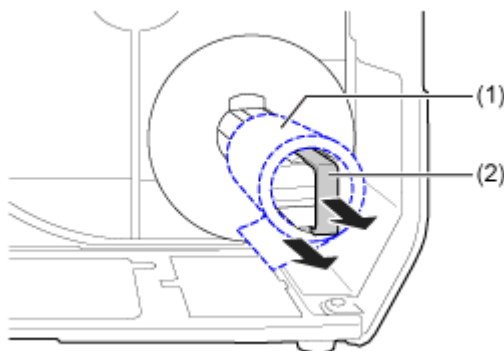

2. Place the clip back to its original position.

Loading Ribbon (Thermal Transfer Only)

You need to load the ribbon when printing using thermal transfer. The topics here explain how to load and replace the ribbon.

Checking the Ink Side of the Ribbon

There are two wind directions for the ribbon. Face-out means the ink is on the outer side and Face-in means the ink is on the inner side. The product supports both wind directions. You can examine the ink side of the ribbon using the following procedure.

1. Place the outer side of the ribbon onto the media (touching).

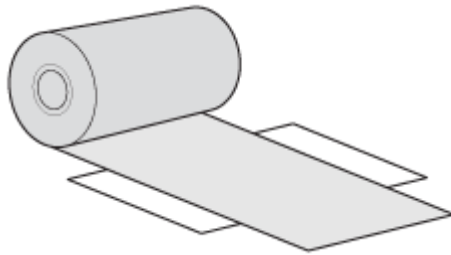

2. Scratch the inner side of the ribbon with your fingernail or a pointed object.

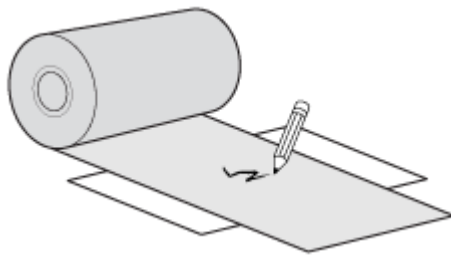

If there is a mark on the media, the ink is coated on the outer side of the ribbon.

- The ink is coated on the outer side. (Face-out ribbon)

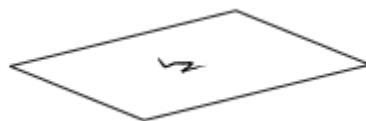

- The ink is coated on the inner side. (Face-in ribbon)

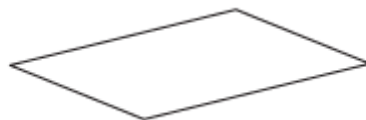

Loading the Ribbon



- The print head and its surroundings are hot after printing. Be careful not to get burned.
 - Touching the edge of the print head with your bare hand could cause injury.
-



- Use genuine SATO media and ribbons for the product, for optimum print quality.
- The routing path of the ribbon is shown in the below picture.

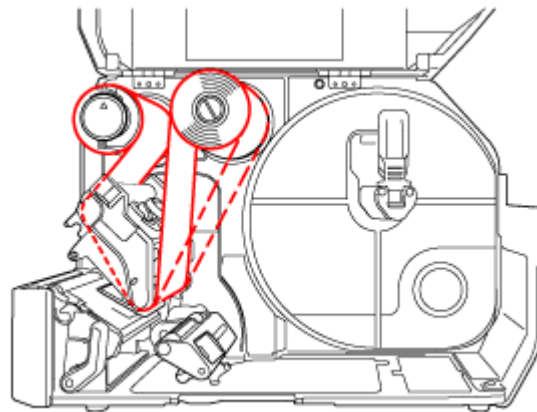

—
Face-in ribbon

- - -
Face-out ribbon

- You can also refer to the sticker located on the inner side of the top cover.
-

1. Open the top cover (1).



- Open the top cover fully to prevent accidental drop of the cover.

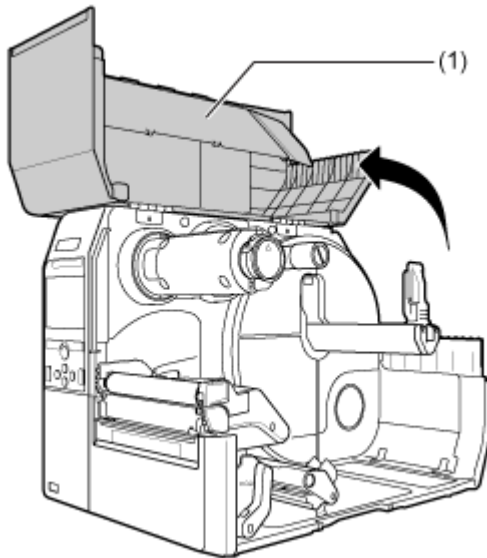

2. Push the ribbon rewind spindle (2) all the way in.

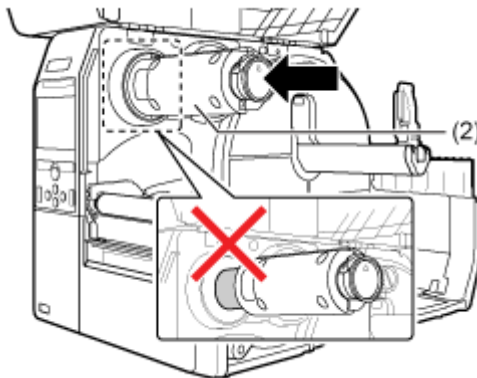

If there is any ribbon on the ribbon rewind spindle, remove it from the spindle before installing new ribbon.

3. Push the head lock lever (3) towards the rear.

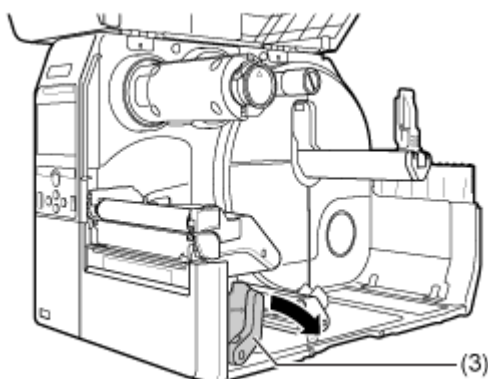

4. Load the ribbon (4) onto the ribbon supply spindle (5).

While taking note of the wind direction, insert the ribbon all the way in.

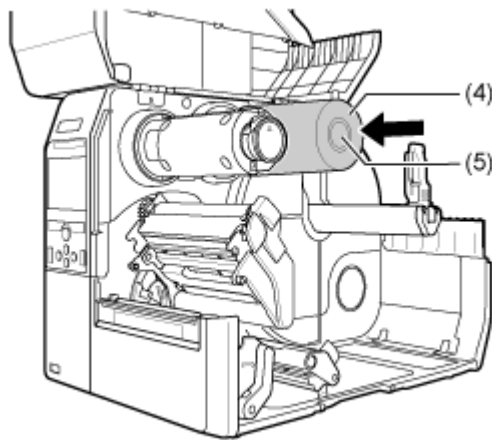

5. From the ribbon supply spindle (5), pass the ribbon below the print head (6).

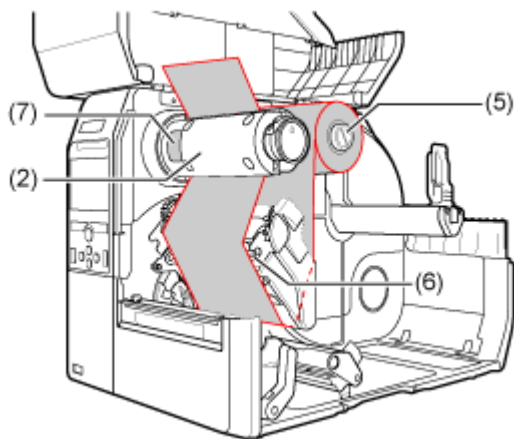

6. Wind the ribbon counterclockwise to the ribbon rewind spindle (2) and grip sheet (7).

Turn the ribbon rewind spindle counterclockwise for several rounds, to wind the ribbon.

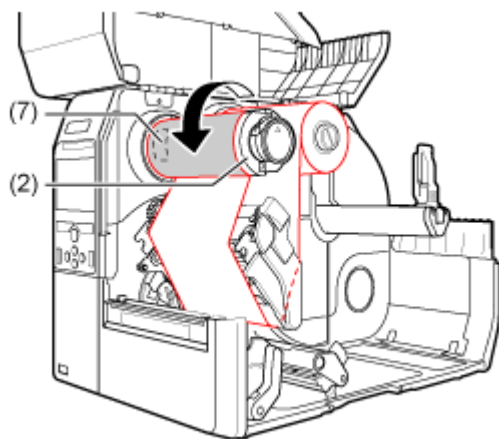

7. If the media is already loaded, press the print head down until the head lock lever is locked.

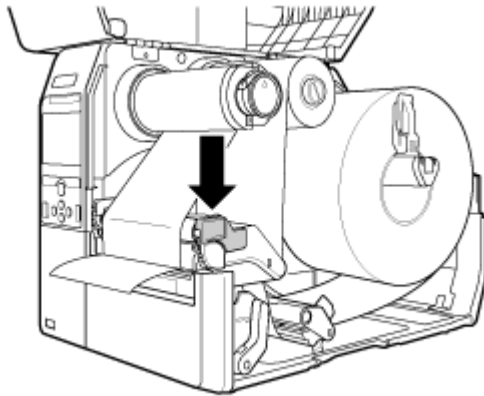

If the media is not loaded, load the media.

8. **Close the top cover.**



- When closing the top cover, be careful not to pinch your fingers.
-

Replacing the Ribbon

1. Open the top cover (1).



- Open the top cover fully to prevent accidental drop of the cover.

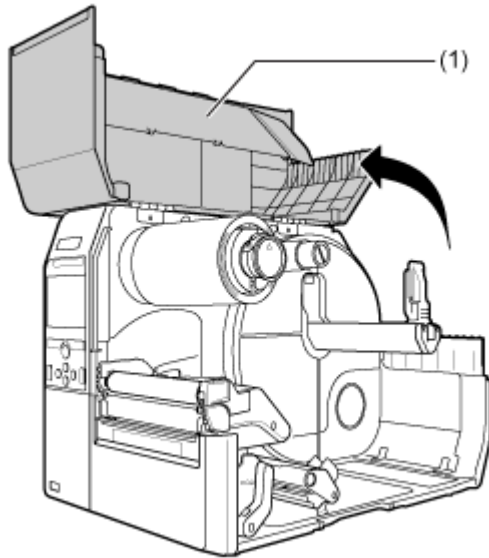

2. Push the head lock lever (2) towards the rear.

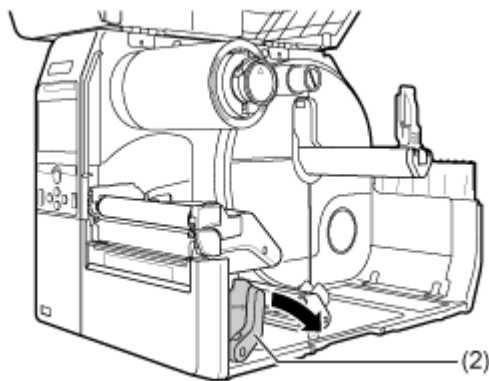

3. Press the tab (3) on the tip of the ribbon rewind spindle to pull it out.

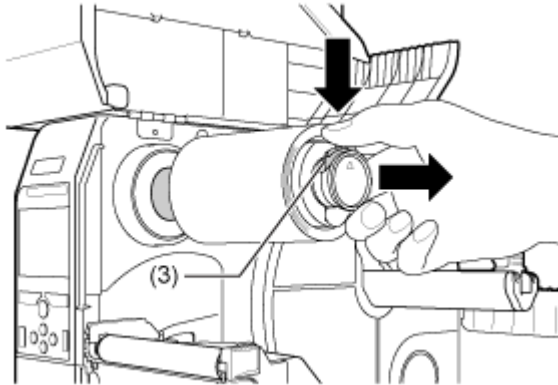

4. Pull to remove the used ribbon from the ribbon rewind spindle.

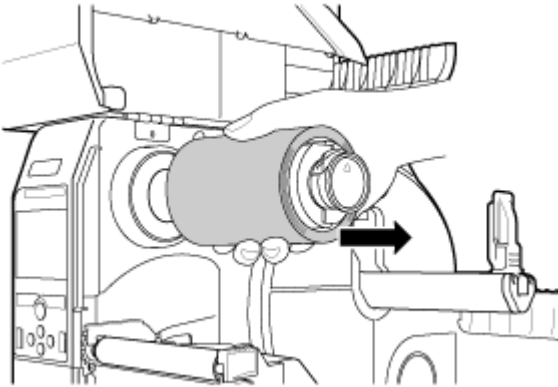

5. Push the ribbon rewind spindle (4) all the way in.

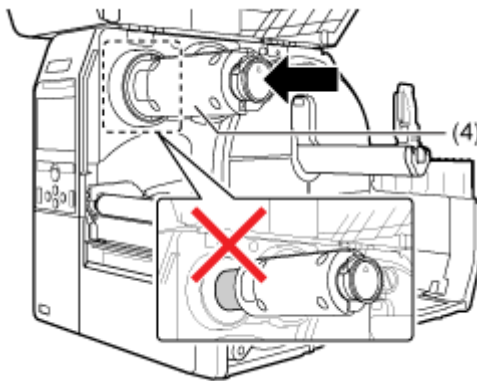

6. Remove the used ribbon core from the ribbon supply spindle.

7. Load the ribbon (5) onto the ribbon supply spindle (6).

While taking note of the wind direction, insert the ribbon all the way in.

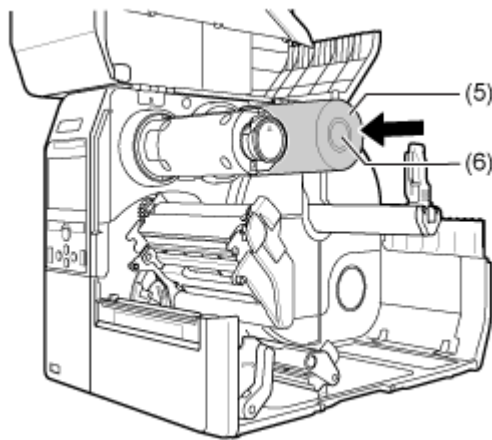

8. From the ribbon supply spindle (6), pass the ribbon below the print head (7).

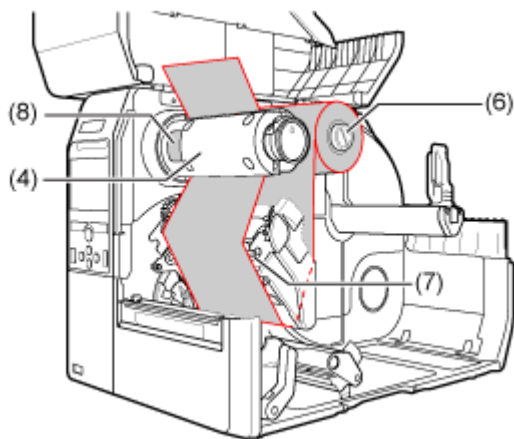

9. Wind the ribbon counterclockwise to the ribbon rewind spindle (4) and grip sheet (8).

Turn the ribbon rewind spindle counterclockwise for several rounds, to wind the ribbon.

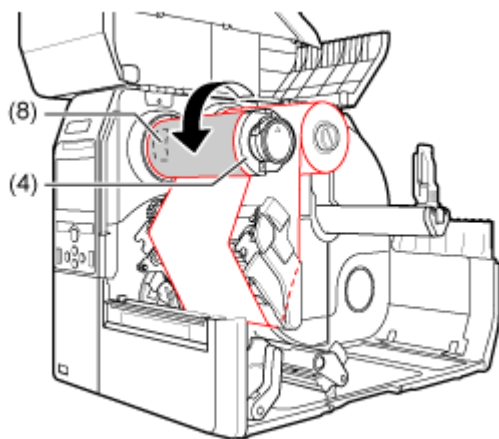

10. Press the print head down until the head lock lever is locked.

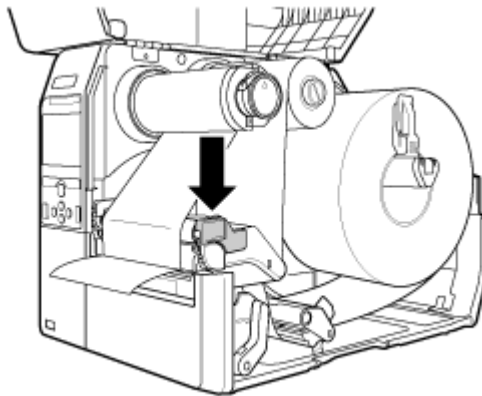

11. Close the top cover.



- When closing the top cover, be careful not to pinch your fingers.
-

12. Press the  button (FEED) in Offline mode to feed the media.

13. Press the  button (ONLINE) to change to Online mode.

When to Replace Media and Ribbon

Checking the Remaining Amount of Media and Ribbon

You can check the remaining amount of media and ribbon according to the following procedure.

- **Checking through the window on the right side of the product**

You can visually check the remaining amount of media and ribbon in the product through the window on the right side of the product (1).

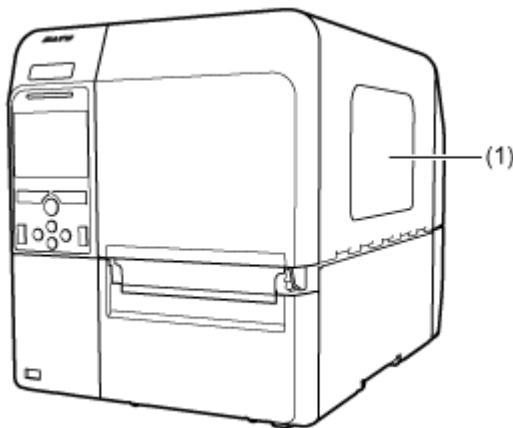

- **Checking through the notifications of the product**

The product has Near End and End detection functions for the media and ribbon.

With icons and error messages on the display of the product, you can check if you need to replace the media or ribbon soon, or if the remaining amount of media and ribbon is scarce.

Conditions That Trigger Paper End

The conditions that trigger paper end vary depending on the operation of the product.

Conditions That Trigger Paper End in the Feeding Operation

A paper-end occurs if the no-paper condition persists even after the paper-end sensor detects the no-paper condition when 15 mm (0.59") continues to be fed.

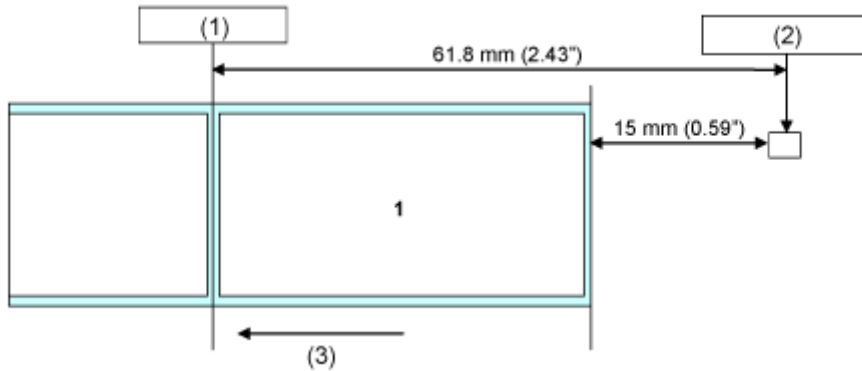

(1) Print head position

(2) Paper end sensor: I-mark sensor/Gap sensor

Select in [Printing] > [Advanced] > [Paper End] menu, or specify by command.

(3) Media feed direction

Conditions That Trigger Paper End in the Printing Operation

1. The paper end sensor detects a no-paper condition at the position where 15 mm (0.59") has been fed.
2. If the amount of printing remaining is less than the distance between the print head position and paper end sensor -15 mm (-0.59"), a paper end error occurs after completing the output of 1.
If the amount of media remaining is more than the distance between the print head position and paper end sensor -15 mm (-0.59"), a paper end error occurs right after detecting the paper end, and the product will reprint after clearing the paper end error.

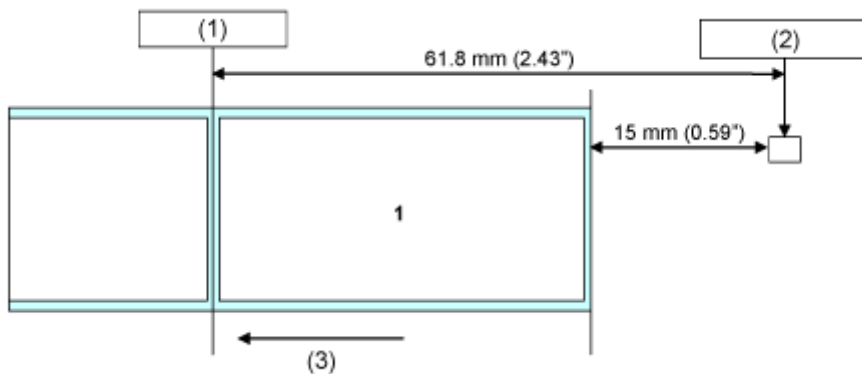

(1) Print head position

(2) Paper end sensor: I-mark sensor/Gap sensor

Select in [Printing] > [Advanced] > [Paper End] menu, or specify by command.

(3) Media feed direction

If a paper end error is detected while printing, operation varies depending on the amounts of printing and media remaining when the error was detected.

The amount of media remaining can be calculated as follows:

Amount of media remaining = distance between print head position and paper end sensor -15 mm (-0.59")

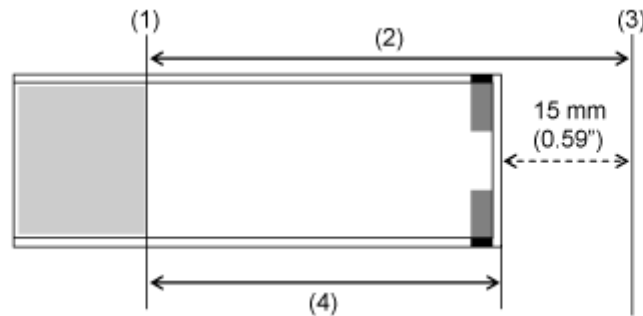

(1) Print head position

(2) Distance between the print head position and paper end sensor

(3) Paper end sensor

(4) Amount of media remaining

- **When the Amount of Printing Remaining Is More Than the Amount of Media Remaining**

If the amount of printing remaining is more than the amount of media remaining when a paper end error is detected, the product cannot finish the print job. Printing stops immediately and a paper end error occurs.

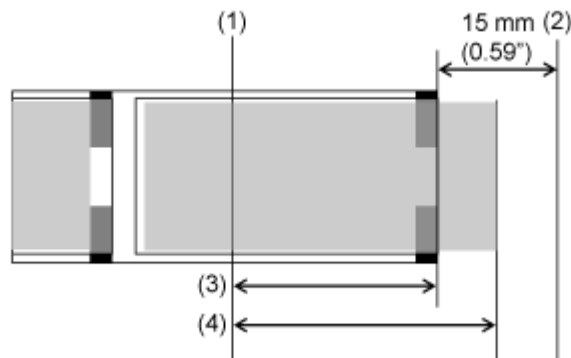

(1) Print head position

(2) Paper end sensor

(3) Amount of media remaining

(4) Amount of printing remaining

- **When the Amount of Printing Remaining Is Less Than the Amount of Media Remaining**

If the amount of printing remaining is less than the amount of media remaining, the product will finish the print job and a paper end error will occur.

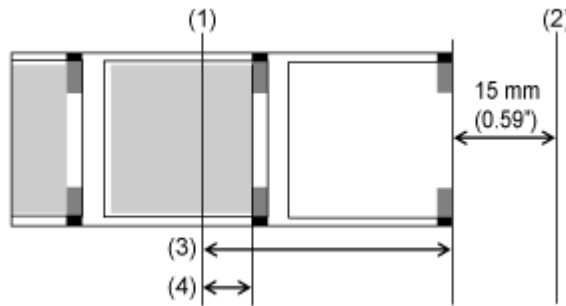

(1) Print head position

(2) Paper end sensor

(3) Amount of media remaining

(4) Amount of printing remaining

If there are multiple sheets between the print head and paper end sensor when a paper end error is detected, a paper end error will occur only after finishing the label currently being printed.

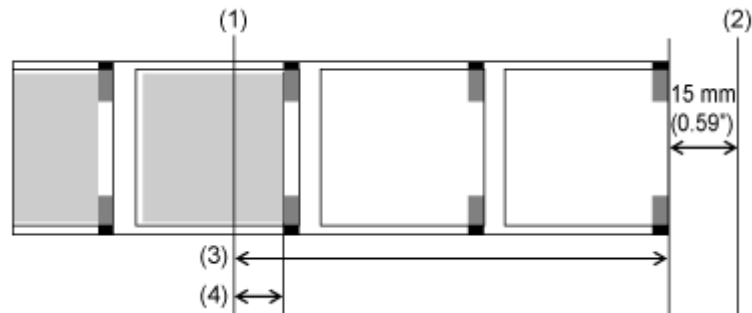

(1) Print head position

(2) Paper end sensor

(3) Amount of media remaining

(4) Amount of printing remaining

Conditions That Trigger Label Near End

Label near end is detected by the label near end sensor.

Label near end occurs when the amount of label remaining is less than approximately 12 meters (39.4 feet) (media thickness: 160 μm (0.0063"), label diameter: approximately $\phi 96$ mm (3" core)).



- Detection of the label near end is only for reference. The timing of label near end and paper end may overlap, or the paper end may occur before the label near end occurs depending on the label thickness and the top and bottom fluttering of the paper core.
-

Conditions That Trigger Ribbon End

Ribbon end error is detected by the ribbon sensor in the ribbon supply spindle. Ribbon end error occurs when the product detects that the ribbon in the ribbon supply spindle has not moved (rolled) more than 15 mm (0.59") after feeding the media.

Conditions That Trigger Ribbon Near End

Ribbon near end is detected by the ribbon sensor in the ribbon supply spindle. Ribbon near end occurs when the amount of ribbon remaining is approximately less than 15 meters (49.2 feet) (ribbon diameter: approximately 36 mm (1.42")).



- The amount of ribbon remaining (15 meters (49.2 feet)) is only for reference. The timing of ribbon near end varies depending on the ribbon thickness and the reading status of the ribbon sensor.
-

Various Settings of the Product

The Product's [Settings] Menu



[Shortcut] Menu

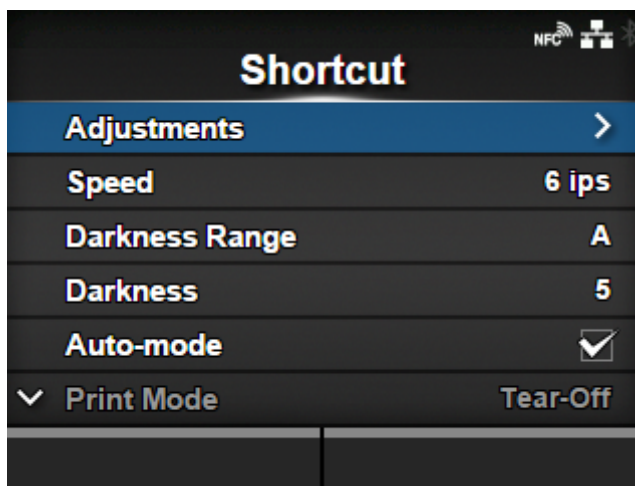

Frequently used settings are listed in the [Shortcut] menu.



[Printing] Menu



The following settings are available in the [Printing] menu:

[Label Length](#)

Set the length of the media.

[Label Width](#)

Set the width of the media.

[Auto Measure](#)

Automatically measure the length of the media.

[Printing Mode](#)

Set whether to print using a ribbon or direct thermal media.

[Ribbon Near End](#)

Enable or disable the warning when the ribbon is about to run out.

- Appears if you have selected [Use Ribbon] in the [Printing Mode] menu.

[Speed](#)

Set the print speed.

[Sensor Type](#)

Set the media sensor type.

[Micro Label Print Mode](#)

Set the micro label print mode.

[Auto-mode](#)

Automatically set the print mode.

[Print Mode](#)

Manually set the print mode.

[Backfeed](#)

Set the backfeed operation.

[Eject Cut](#)

Set the time from the print completion until the print cut.

- Appears if you have selected [Cut & Print] in the [Print Mode] menu.

[Darkness Range](#)

Set the range of the print darkness.

[Darkness](#)

Set the print darkness.

[Imaging](#)

Set the print reference position in the vertical and horizontal directions.

[Advanced](#)

Set the sensor operation and print motion.

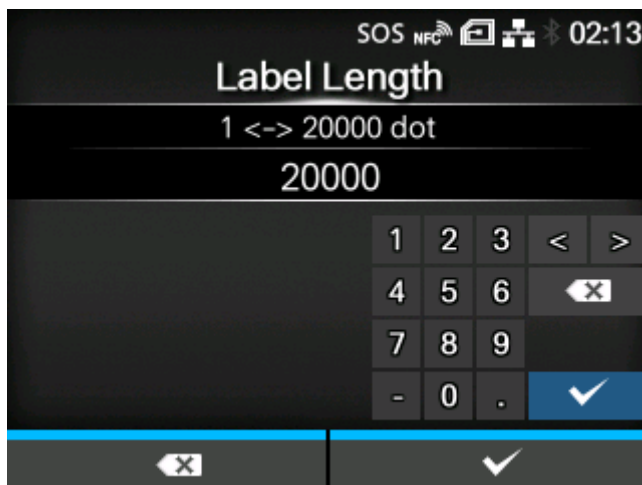
[\[Label Length\]](#)

Set the length of the media.

The setting range varies depending on the print resolution of the product.

The setting range of the label length is as follows:

Resolution	CL4NX Plus	CL6NX Plus
203 dpi (1 dot = 0.125 mm (0.0049"))	1 to 20000 dots	1 to 20000 dots
305 dpi (1 dot = 0.083 mm (0.0033"))	1 to 18000 dots	1 to 18000 dots

Resolution	CL4NX Plus	CL6NX Plus
609 dpi (1 dot = 0.042 mm (0.0017"))	1 to 9600 dots	-



- Set the label size to a value that includes the liner.

[Label Width]



Set the width of the media.

The setting range varies depending on the print resolution of the product.

The setting range of the label width is as follows:

Resolution	CL4NX Plus	CL6NX Plus If [Head Base Position] is [Standard]	CL6NX Plus If [Head Base Position] is [Left-justify]
203 dpi (1 dot = 0.125 mm (0.0049"))	1 to 832 dots	1 to 1216 dots	1 to 1340 dots
305 dpi (1 dot = 0.083 mm (0.0033"))	1 to 1248 dots	1 to 1984 dots	1 to 2010 dots
609 dpi (1 dot = 0.042 mm (0.0017"))	1 to 2496 dots	-	-



- Set the label size to a value that includes the liner.
-

[Auto Measure]

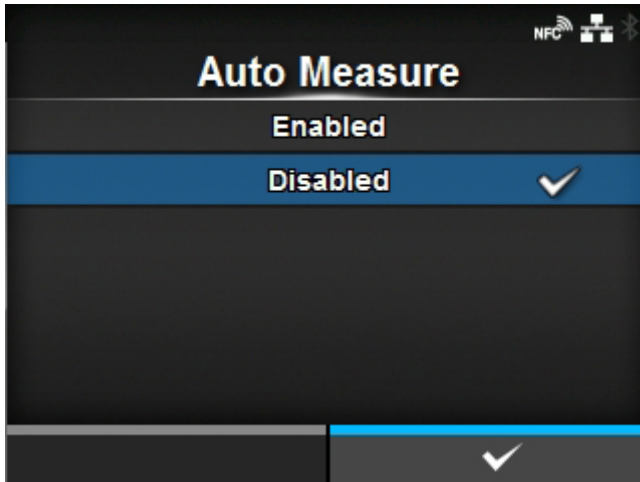



The product automatically measures the length of the media.

The measured length of the media will be automatically saved in [Label Length].

The Auto Measure function can be performed when [Sensor Type] is set to [Gap] or [I-Mark].

The setting procedure of the label length using the Auto Measure function is as follows:

1. Load the media.
2. Set [Auto Measure] to [Enabled].
3. Press the  button or  button to show the Online or Offline screen.
4. Open the print head. (Head Open error occurs.)
5. Close the print head. (The display returns to Offline screen.)
6. When you press the  button, the product feeds two pieces of label and measures the label length.
7. The measured label length is saved in [Label Length].



- When you have set [Auto Measure] to [Enabled], this function executes when the product powers on.
-

[Printing Mode]

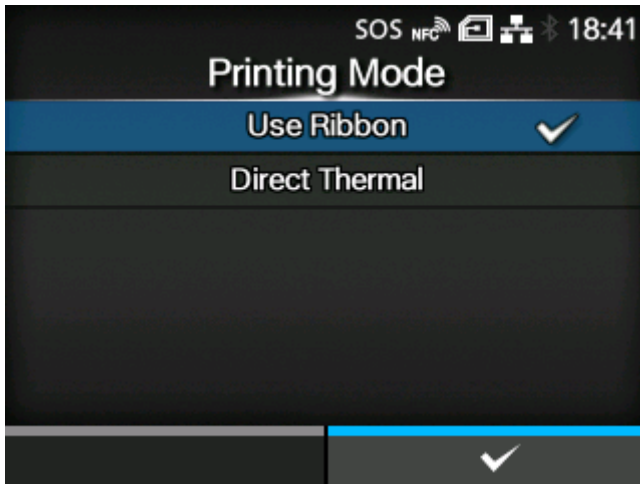

Set whether to print using a ribbon or direct thermal media.

The options are as follows:

Use Ribbon

Print using a ribbon.

Direct Thermal

Print using direct thermal media.

[Ribbon Near End]

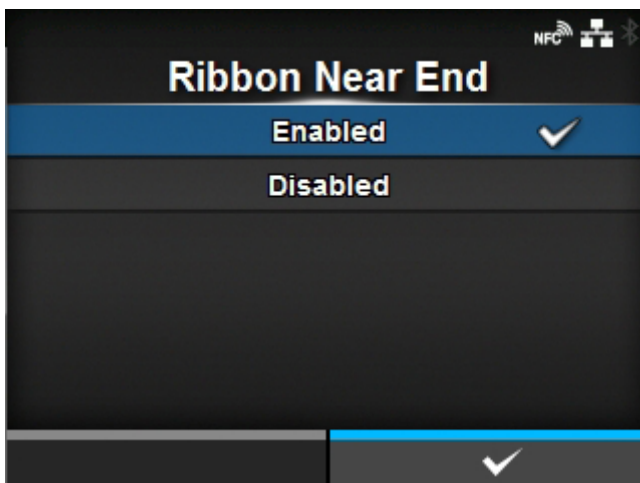

Set whether to detect ribbon near end when the ribbon is nearing the end.

When this setting is enabled and a ribbon near end is detected, this product operates as follows;

- Printing does not stop.
- The warning icon appears on the screen.
- The ribbon near end state is output to returning the product status and external signal.

Appears if you have selected [Use Ribbon] in the [Printing Mode] menu.

The options are as follows:

Enabled

Enable detection of the ribbon near end.

Disabled

Disable detection of the ribbon near end.



- The warning icon is shown in the status bar on the upper part of the screen.
-

[Speed]

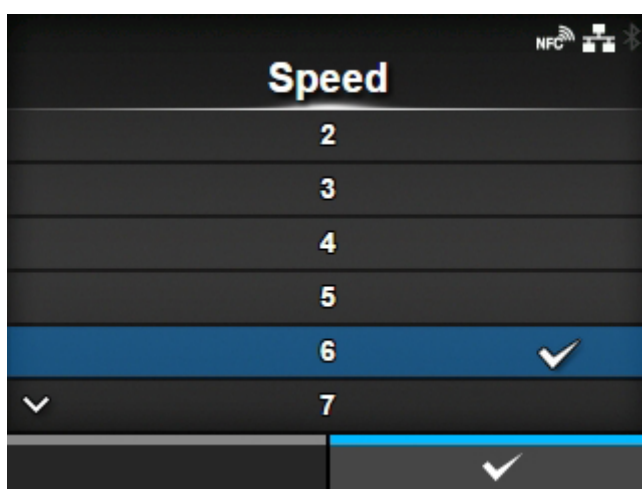

The setting range varies depending on the print resolution of the product.

The setting range of the print speed is as follows:

Resolution	CL4NX Plus	CL6NX Plus
203 dpi (8 dots/mm)	2 to 14 ips (inches/sec) (50.8 to 355.6 mm/sec)	2 to 10 ips (inches/sec) (50.8 to 254 mm/sec)
305 dpi (12 dots/mm)	2 to 14 ips (inches/sec) (50.8 to 355.6 mm/sec)	2 to 8 ips (inches/sec) (50.8 to 203.2 mm/sec)
609 dpi (24 dots/mm)	2 to 6 ips (inches/sec) (50.8 to 152 mm/sec)	-



- If the optional dispenser unit is installed to CL4NX Plus, and [Dispenser] is selected in the [Print Mode] menu, the setting range is 2 to 10 ips (inches/sec) (50.8 to 254 mm/sec) (If the print resolution is 203 dpi or 305 dpi).
- If the optional linerless cutter kit is installed to CL4NX Plus, the setting range is as follows:
 - The setting range is 2 to 6 ips (inches/sec) (50.8 to 152 mm/sec) regardless of the printing resolution.
 - If the [Speed] is set more than 7 ips (177.8 mm/sec), it is changed to 4 ips after installing the linerless cutter kit.
- Setting the print speed to a level that is too fast may affect the print quality.

[Sensor Type]

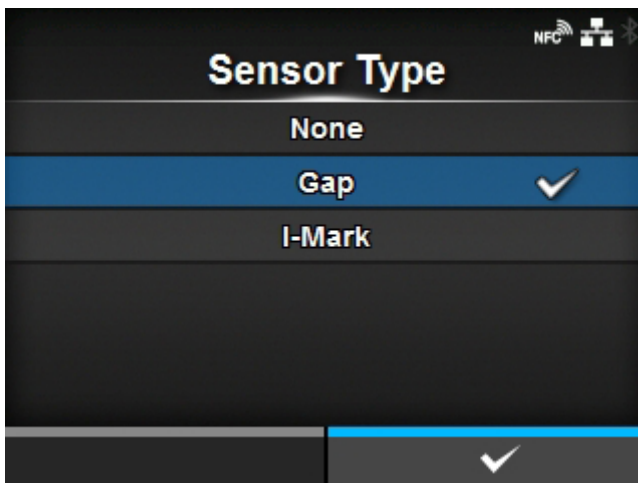

Set the sensor type for detecting the media.

The options are as follows:

None

Disable the media sensor.

Gap

Select when using gap type media. Use the transmissive type sensor.

I-Mark

Select when using I-mark type media. Use the reflective type sensor.



- If you have selected [Tear-Off], [Dispenser], or [Cut & Print] in the [Print Mode] menu, only [Gap] and [I-Mark] will be available.
- If you have selected [Linerless] in the [Print Mode] menu (CL4NX Plus only), only [None] and [I-Mark] will be available.

[Micro Label Print Mode]



Set the micro label print mode operation.

Micro Label Print Mode is a mode to provide high accuracy printing for small sized labels.



- The accuracy of Micro Label Print Mode is dependent on the usage conditions, including quality of label production, print layout, and ribbon sizes.

The following conditions are recommended,

- Ribbon length: Less than 300 m
- Used media sensor: Gap sensor
- Head pressure balance: as follows;

Media Width (mm (inch)) and Adjustment Dials (for CL4NX Plus)

25 - 54 (0.98" - 2.13") : Left: **5**, Right: **1**

54 - 83 (2.13" - 3.27") : Left: **5**, Right: **3**

83 - 131 (3.27" - 5.16") : Left: **3**, Right: **3**

Media Width (mm (inch)) and Adjustment Dials (for CL6NX Plus)

50 - 90 (1.97" - 3.54") : Left: **5**, Right: **1**

90 - 130 (3.54" - 5.12") : Left: **5**, Right: **3**

130 - 180 (5.12" - 7.09") : Left: **3**, Right: **3**

- The improved accuracy provided by micro label print mode is for labels sizes of less than 53 mm (incl. GAP).
- When the Micro Label Print Mode is enabled when print speed is 7ips or above, the print speed will be automatically reduced to 6ips.
- When using RFID models, Micro Label Print Mode cannot be used.

The setting items are as follows:

[Micro Label Print Mode](#)

Enable or disable the micro label print mode.

[Auto Label Length Detection](#)

Enable or disable the auto label length detection.

- Available if [Micro Label Print Mode] is set to [Enabled].

[Label Length Averaging Count](#)

Set the number of labels measured to be used for averaging the automatically set label length.

- Available if [Micro Label Print Mode] is set to [Enabled] and [Auto Label Length Detection] is set to [Enabled].

[Label Length](#)

Set the label length manually.

- Available if [Micro Label Print Mode] is set to [Enabled] and [Auto Label Length Detection] is set to [Disabled].



- If the print start position is out of alignment when using [Auto Label Length Detection], use [Label Length] to set the label length manually.
-

[\[Micro Label Print Mode\]](#)

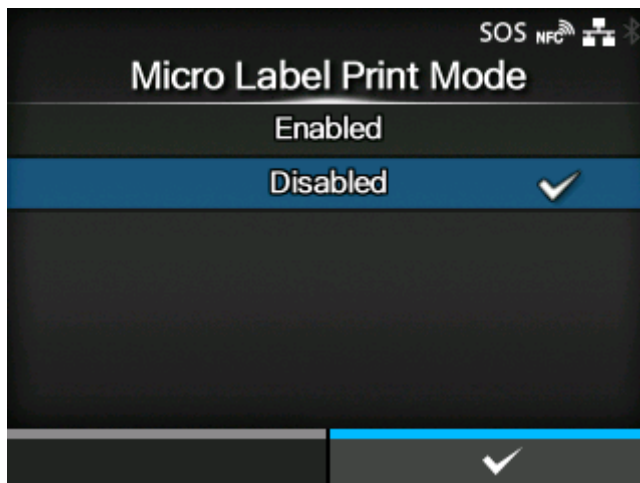

Enable or disable the use of Micro Label Print Mode.

The options are as follows:

Enabled

Enable Micro Label Print Mode.

Disabled

Disable Micro Label Print Mode.

[Auto Label Length Detection]

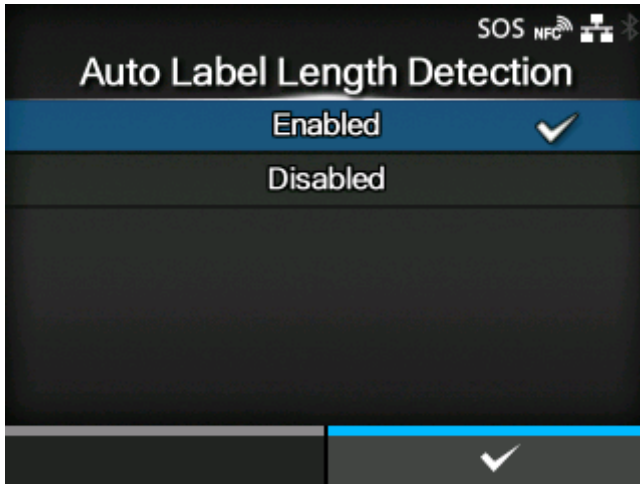

Enable or disable automatic measurement of label length when the [Micro Label Print Mode] is set to [Enabled].

The options are as follows:

Enabled

Enable the auto label length detection.

Disabled

Disable the auto label length detection.

[Label Length Averaging Count]

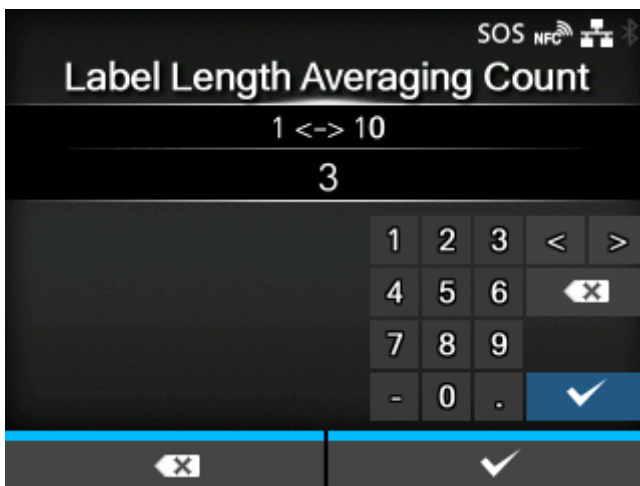

Set the number of labels measured to be used for averaging the automatically set label length when the [Micro Label Print Mode] is set to [Enabled] and the [Auto Label Length Detection] is set to [Enabled].

The setting range is from 1 to 10.

[Label Length]

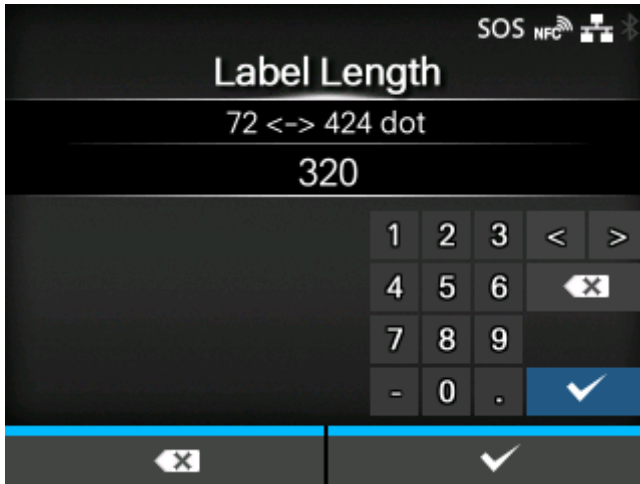

Set the label length manually when the [Micro Label Print Mode] is set to [Enabled] and the [Auto Label Length Detection] is set to [Disabled].

The setting range varies depending on the print resolution of the product.

The setting range of the label length is as follows:

Resolution	CL4NX Plus	CL6NX Plus
203 dpi (1 dot = 0.125 mm (0.0049"))	72 to 424 dots	72 to 424 dots
305 dpi (1 dot = 0.083 mm (0.0033"))	108 to 636 dots	108 to 636 dots
609 dpi (1 dot = 0.042 mm (0.0017"))	216 to 1272 dots	-



- Set the label size to a value that includes the liner.

[Auto-mode]

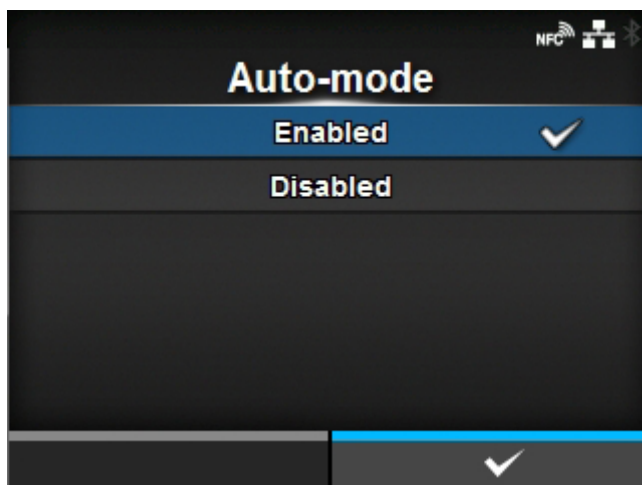

When using [Auto-mode], the print mode changes automatically according to the status of the installed option unit.

The options are as follows:

Enabled

The print mode changes automatically.

Disabled

The print mode changes according to the setting of the [Print Mode].



- Operate in cutter mode if you have installed the optional cutter unit or rotary cutter unit.
- Operate in dispenser mode if you have installed the optional dispenser unit.
- Operate in linerless mode if you have installed the optional linerless cutter kit (CL4NX Plus only).

[Print Mode]

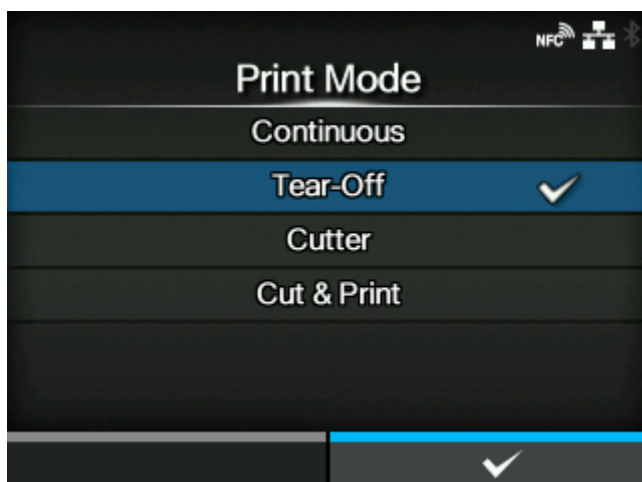

Set the print mode.

The options are as follows:

Continuous

Continuously print the specified number of the media. The media remains in position for printing at all times.

Tear-Off (Feeding media to the position for manual cutting)

After continuously printing the specified number of the media, feed the media to the point to remove the media. After printing, tear off the media manually. The media will be back to the print head position for starting the next printing.

Cutter

Cut each media while printing the specified number of media. You can specify this option if you have installed the cutter unit or the rotary cutter unit.

Cut & Print

Allows you to continuously print and cut at the specified media repeat. If no print data is received within the period specified for [Eject Cut], the product will feed the media to the cut position and cut the last printed media. Media errors do not occur when using cut & print mode. You can specify this option if you have installed the cutter unit or the rotary cutter unit.

Dispenser

Peel the liner from the printed label as the label is fed to the product's front. Once the printed label has been removed from the product for application, the next label will retract and position itself for printing. You can specify this option if you have installed the dispenser unit.

Linerless (CL4NX Plus only)

Cut each label while printing the specified number of labels. You can specify this option if you have installed the linerless cutter kit.



- Do not select Linerless Mode to use RFID tags on an RFID model. If you set Linerless Mode, you cannot use RFID tags.
-



- If no option is installed, [Continuous] and [Tear-Off] are available.
 - If the optional cutter unit is installed, [Continuous], [Tear-Off], [Cutter], and [Cut & Print] are available.
 - If the optional rotary cutter unit is installed to CL4NX Plus, [Cutter] and [Cut & Print] are available.
 - If the optional dispenser unit is installed, [Continuous], [Tear-Off], and [Dispenser] are available.
 - If the optional linerless cutter kit is installed to CL4NX Plus, only [Linerless] is available.
 - You cannot set the [Print Mode] if [Auto-mode] is [Enabled].
-

[Backfeed]

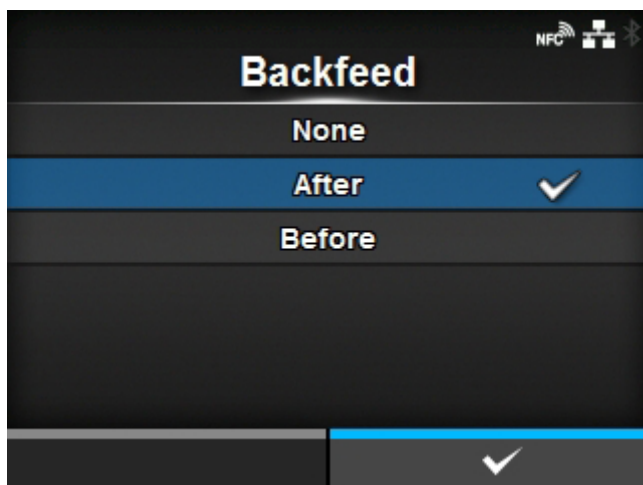

[Backfeed] is applicable when the print mode is set to tear-off mode, cutter mode, cut & print mode, dispenser mode or linerless mode (CL4NX Plus only).

The options are as follows:

None

Do not backfeed.

After

After cut, backfeed the front part of the next media to the print head position. For dispenser mode, backfeed the front part of the next label after dispensing the label.

Before

Before printing, backfeed the front part of the next media to the print head position.



- If you have selected [Tear-Off] or [Linerless] (CL4NX Plus only) in the [Print Mode], only [Before] is available.
 - If you have selected [Cut & Print] in the [Print Mode], only [After] is available.
-

[Eject Cut]



Set the Eject cut motion for the last printed media. Cut the last media after the specified timing. Appears if you have selected [Cut & Print] in the [Print Mode] menu. The setting range is Off, or from 1 to 5 (sec).

[Darkness Range]

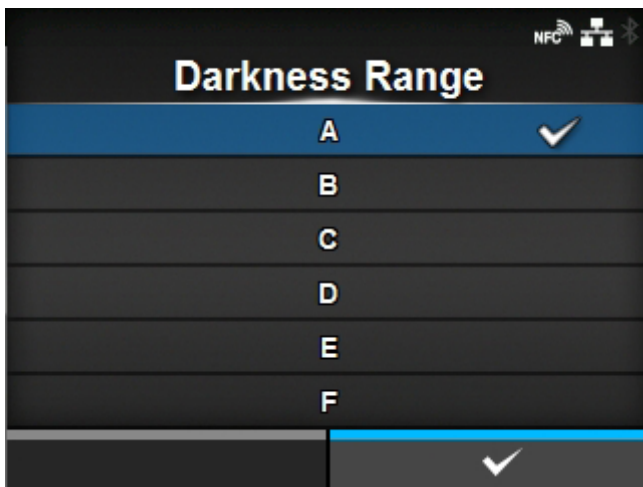

Set the range of the print darkness.
The darkness range affects the print darkness.
The options are as follows:
A, B, C, D, E, F



- The normal setting is A. You can also select B to F but the print darkness does not change.

[Darkness]

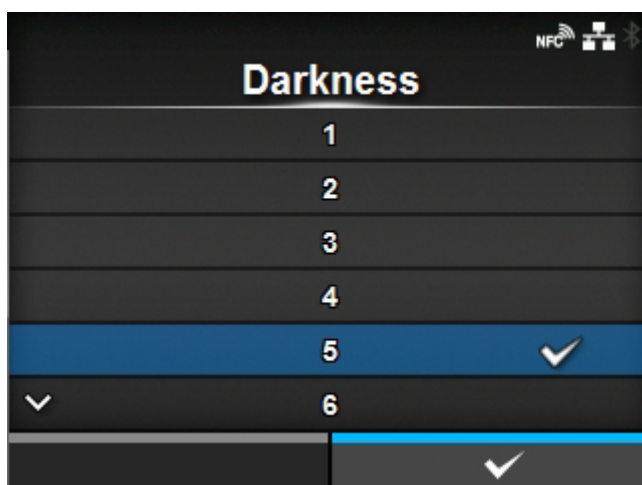

Specify the print darkness from 10 steps.

The setting range is from 1 to 10. 1 is the lightest and 10 is the darkest.



- To further fine tune the print darkness, set [Printing] > [Advanced] > [Adjustments] > [Darkness Adjust].

[Imaging]

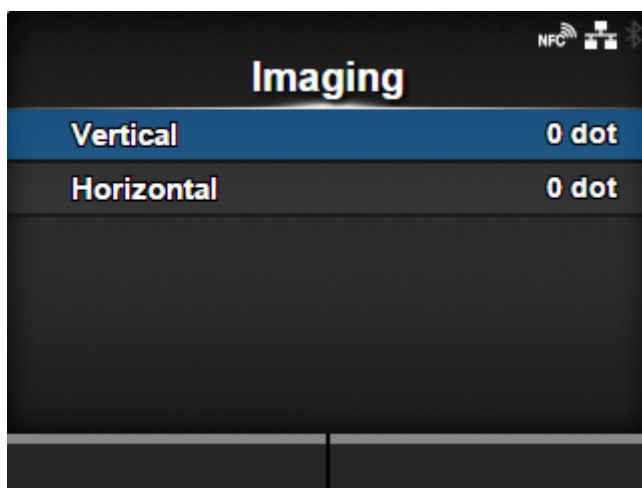

Set the print reference position in the vertical and horizontal directions.

The setting items are as follows:

[Vertical](#)

Adjust the print position in the vertical (feed) direction.

[Horizontal](#)

Adjust the print position in the horizontal direction.

Adjusting direction of the print reference position and base reference point

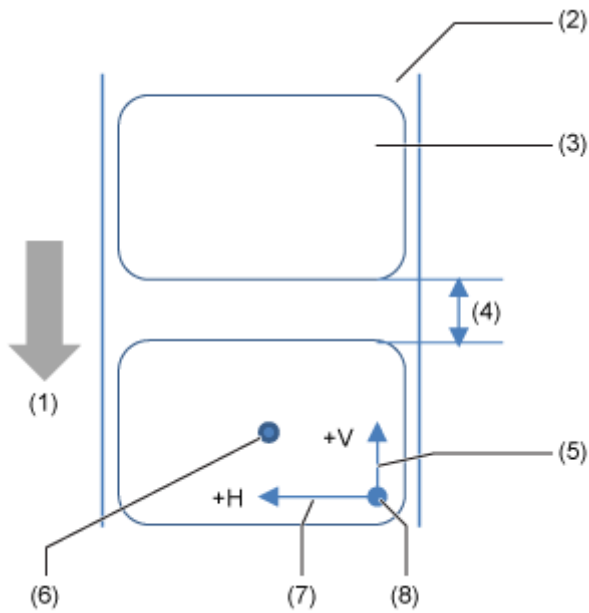

- (1) Feed direction
- (2) Liner
- (3) Label
- (4) Gap between labels
- (5) Adjustment of vertical base reference point
- (6) Base reference point after adjustment
- (7) Adjustment of horizontal base reference point
- (8) Print reference position

[Vertical]

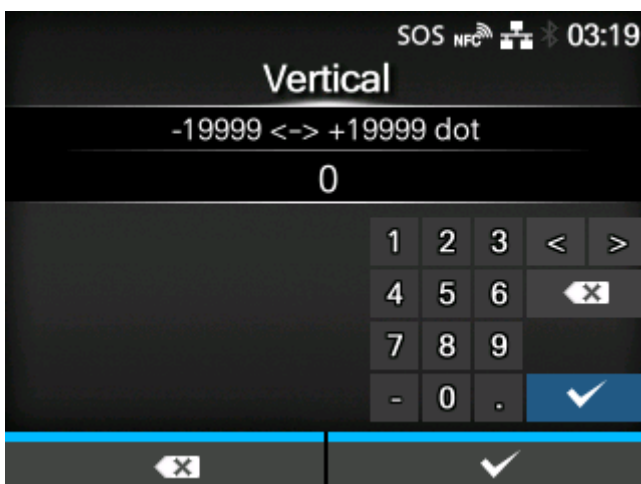

Set the print position in the vertical direction.

Set the correction value from the standard printing position as "-" for the direction of the paper feed and "+" for the direction opposite to the paper feed.

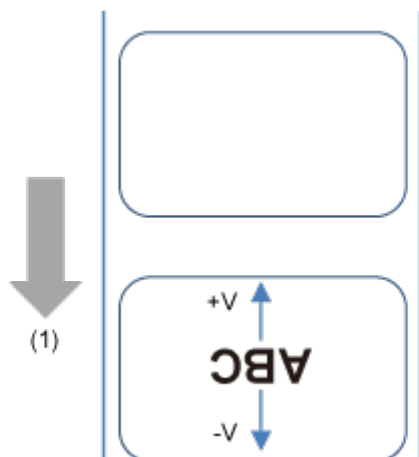

(1) Feed direction

The setting range varies depending on the print resolution of the product.

The setting range is as follows:

Resolution	CL4NX Plus	CL6NX Plus
203 dpi (1 dot = 0.125 mm (0.0049"))	-19999 to 0 to 19999 dots	-19999 to 0 to 19999 dots
305 dpi (1 dot = 0.083 mm (0.0033"))	-17999 to 0 to 17999 dots	-17999 to 0 to 17999 dots
609 dpi (1 dot = 0.042 mm (0.0017"))	-9599 to 0 to 9599 dots	-

[Horizontal]

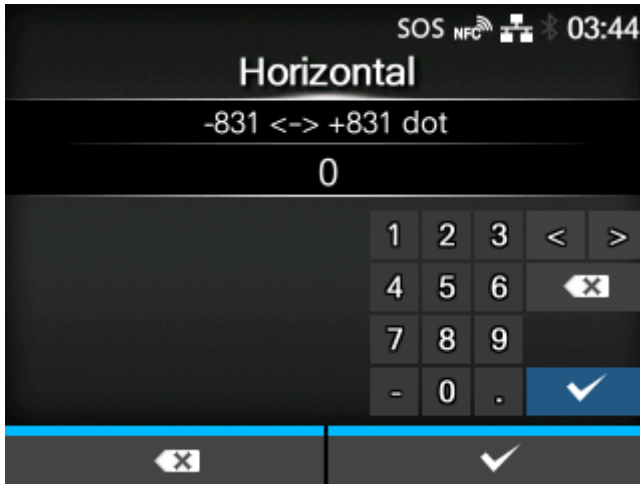

Set the print position in the horizontal direction.

Set the correction value from the standard printing position when facing the product, use "-" to adjust to the right side and "+" to adjust to the left side.

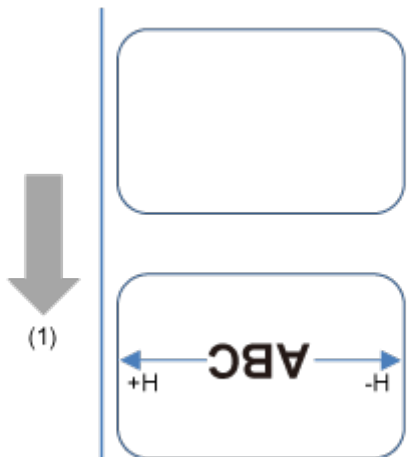

(1) Feed direction

The setting range varies depending on the print resolution of the product.

The setting range is as follows:

Resolution	CL4NX Plus	CL6NX Plus If [Head Base Position] is [Standard]	CL6NX Plus If [Head Base Position] is [Left-justify]
203 dpi (1 dot = 0.125 mm (0.0049"))	-831 to 0 to 831 dots	-1215 to 0 to 1215 dots	-1339 to 0 to 1339 dots
305 dpi	-1247 to 0 to 1247 dots	-1983 to 0 to 1983 dots	-2009 to 0 to 2009 dots

Resolution	CL4NX Plus	CL6NX Plus If [Head Base Position] is [Standard]	CL6NX Plus If [Head Base Position] is [Left-justify]
(1 dot = 0.083 mm (0.0033"))			
609 dpi (1 dot = 0.042 mm (0.0017"))	-2495 to 0 to 2495 dots	-	-

[Advanced]

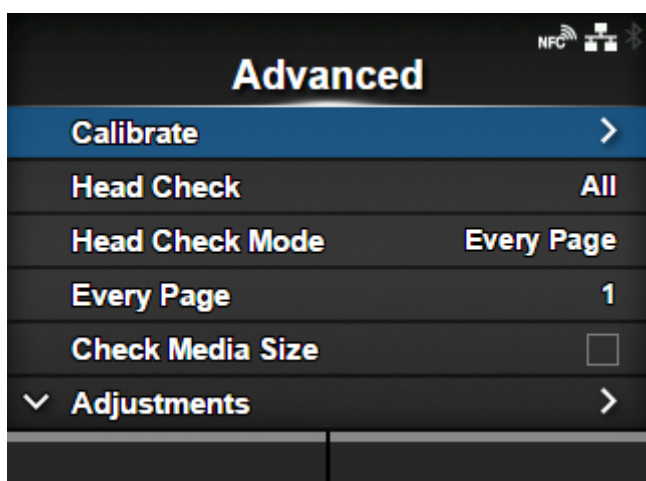

Set detailed sensor operation and print motion.

The setting items are as follows:

[Calibrate](#)

Adjust the media sensor.

[Head Check](#)

Check if there is a broken element of the print head.

[Head Check Mode](#)

Set the mode for head check.

- Appears if you have selected [All] or [Barcode] in the [Head Check] menu.

[Every Page](#)

Set the interval for head check.

- Appears if you have selected [Every Page] in the [Head Check Mode] menu.

[Check Media Size](#)

Enable or disable media size check.

- Appears if you have selected [Gap] or [I-Mark] in the [Sensor Type] menu.

[Adjustments](#)

Correct the offset value, print position and print darkness.

[Start Online](#)

Set whether to power on the product in Online mode.

[Feed After Error](#)

Set whether to automatically feed the media when recovering from an error.

[Feed At Power On](#)

Set whether to automatically feed the media when the product is powered on.

[Finisher Feed](#)

Set the length to feed after printing.

[Paper End](#)

Select the sensor for sensing the paper end.

[Head Base Position](#)

Set the edge position for printing.

[Prioritize](#)

For product settings, set whether to prioritize the settings that are done through the product or through commands.

[Reprint](#)

Enable or disable the reprint function.

[Print End Position](#)

Adjust the media stop position or cut position when [Sensor Type] is set to [None].

[Label Near End](#)

Enable or disable the warning when the media is about to run out.

[Calibrate]

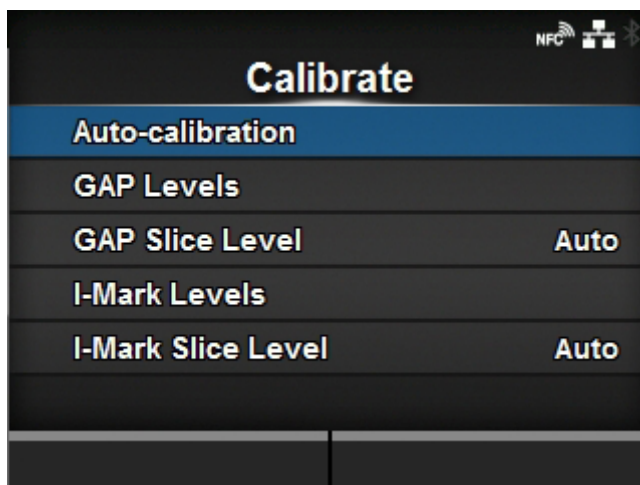

Adjust the media sensor level.

In instances of media detection malfunction, adjust the media sensor level (Gap and I-mark sensors).

The setting items are as follows:

[Auto-calibration](#)

Automatically adjust the sensor level.

- Does not appear if you have installed the optional linerless cutter kit (CL4NX Plus only).

[GAP Levels](#)

Manually set the Gap sensor level.

[GAP Slice Level](#)

Manually set the Gap sensor slice level.

[I-Mark Levels](#)

Manually set the I-mark sensor level.

[I-Mark Slice Level](#)

Manually set the I-mark sensor slice level.

[Auto-calibration]

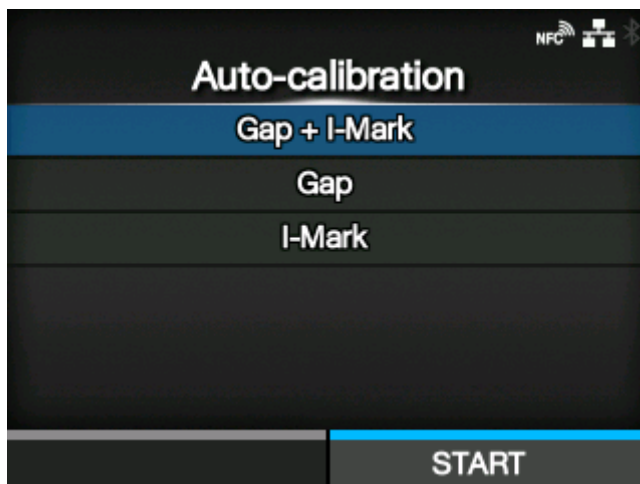

Perform the auto-calibration for the selected media sensor.

[Auto-calibration] is not available if you have installed the optional linerless cutter kit (CL4NX Plus only).

[Gap + I-Mark](#)

Adjusts both the Gap sensor and I-mark sensor.

[Gap](#)







Adjusts the Gap sensor.

[I-Mark](#)

Adjusts the I-mark sensor.

The procedure to auto-calibrate the media sensor is as follows:

1. Push the head lock lever towards the rear to unlock the print head.

2. Pass the media below the media sensor guide. If you are using labels, remove the label from the liner. Align it so that the media sensor does not detect the I-mark (black mark).
3. Press the print head down until the head lock lever is locked. To get the correct adjustment result, adjust after you have locked the print head.
4. Press the  buttons to select the type of sensor to be adjusted.
5. Press the  button or  button.
6. When the confirmation screen appears, press the  button to start the sensor adjustment.
7. The result of the sensor adjustment is shown. To exit the adjustment, press the  button.
8. Set to Offline mode. Press the  button to confirm that the media is fed correctly.



- If the media is not fed correctly after doing [Auto-calibration], contact your SATO reseller or technical support center.

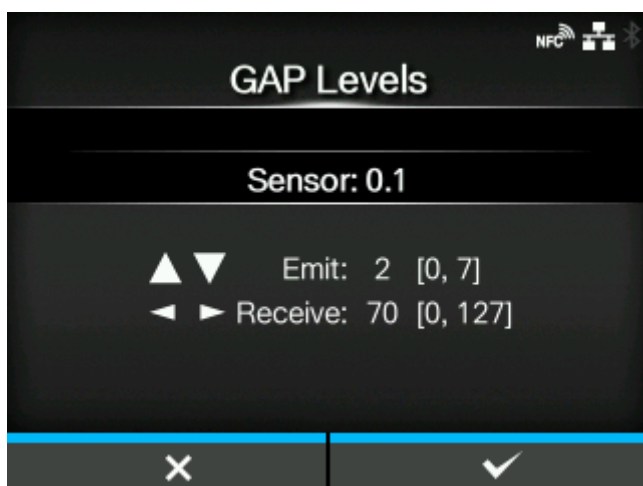

[GAP Levels]



Manually set the Gap sensor level.

The setting procedure is as follows:

First, adjust the "Low" level (voltage) of the Gap sensor.

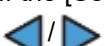
1. Remove the label from the liner.
2. Pass the liner through the media sensor. Align it so that the media sensor does not detect the I-mark (black mark).
3. Close the print head. To get the correct adjustment result, adjust after you have closed the print head.
4. Select the [GAP Levels] in the [Calibrate] menu and press the  button.
5. Press the  buttons to change the [Emit] value until the [Sensor] value is below 0.5 (V). Set the [Emit] value as low as possible.
6. If the [Sensor] value does not decrease below 0.5 after you changed the [Emit] value, press the  buttons to change the [Receive] value.
7. Take a note of the [Sensor] value from the above procedure. This is the "Low" level value for the Gap sensor.

Next, check the "High" level (voltage) of the Gap sensor as follows:

1. Pass the media (attached with liner) between the media sensors. Align it so that the media sensor does not detect the I-mark (black mark).
2. Close the print head.
3. Check the [Sensor] value.

If the value is 1.0 (V) higher than the "Low" level value you have recorded, this is the "High" level value for the Gap sensor.

If the difference between the "High" and the "Low" levels is less than 1.0, adjust the [Emit] and [Receive] values so that the difference is more than 1.0, or adjust the "Low" level (voltage) of the Gap sensor again.

4. If both "High" and "Low" levels comply with the standard value, press the  button to confirm the value.

The standard values for the "High" and "Low" levels for the Gap sensor are as follows:



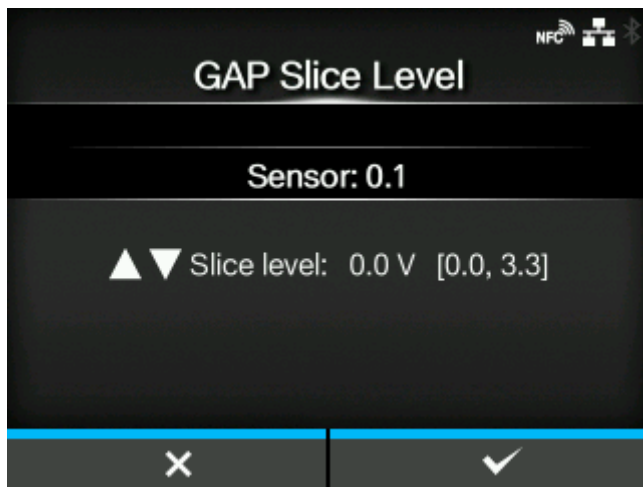

- Low (with only liner) ≤ 0.5 (V)
- High (media attached with liner) - Low ≥ 1.0 (V)

[GAP Slice Level]



Set the Gap sensor slice level.

The setting procedure is as follows:

1. Use the following formula to calculate the slice level:
 $(\text{High level} - \text{Low level}) \times 0.3 + \text{Low level} = \text{slice level}$
2. Select the [GAP Slice Level] in the [Calibrate] menu and press the  button.
3. Press the  /  buttons to change the [Slice level] value. Set the [Slice level] to the level calculated in step 1.
4. Press the  button to confirm the value.



- If you set the [Slice level] to 0.0 (V), the product sets the slice level automatically.





[I-Mark Levels]



Manually set the I-mark sensor level.

The setting procedure is as follows:

First, adjust the "Low" level (voltage) of the I-mark sensor.

1. Pass the media (attached with liner) between the media sensors. Align it so that the media sensor does not detect the I-mark (black mark).
2. Close the print head. To get the correct adjustment result, adjust after you have closed the print head.
3. Select the [I-Mark Levels] in the [Calibrate] menu and press the  button.
4. Press the  /  buttons to change the [Emit] value until the [Sensor] value is below 0.5 (V). Set the [Emit] value as low as possible.
5. If the [Sensor] value does not decrease below 0.5 after you changed the [Emit] value, press the  /  buttons to change the [Receive] value.
6. Take a note of the [Sensor] value from the above procedure. This is the "Low" level value for the I-mark sensor.

Next, check the "High" level (voltage) of the I-mark sensor as follows:

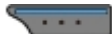
1. Pass the media between the media sensors so that the media sensor can detect the I-mark (black mark).
2. Close the print head.
3. Check the [Sensor] value.
If the value is 1.0 (V) higher than the "Low" level value you have recorded, this is the "High" level value for the I-mark sensor.
If the difference between the "High" and the "Low" levels is less than 1.0, adjust the [Emit] and [Receive] values so that the difference is more than 1.0, or adjust the "Low" level (voltage) of the I-mark sensor again.
4. If both "High" and "Low" levels comply with the standard value, press the  button to confirm the value.

The standard values for the "High" and "Low" levels for the I-mark sensor are as follows:

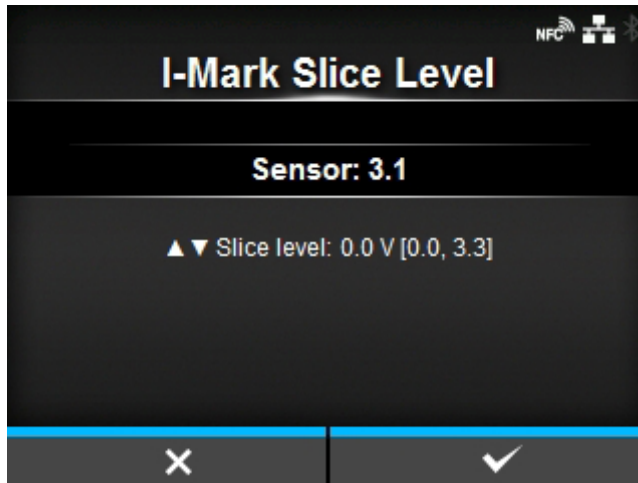

- Low (without I-mark) ≤ 0.5 (V)
- High (with I-mark) - Low ≥ 1.0 (V)

[I-Mark Slice Level]



Set the I-mark sensor slice level.

The setting procedure is as follows:

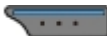
1. Use the following formula to calculate the slice level:
 $(\text{High level} - \text{Low level}) \times 0.7 + \text{Low level} = \text{slice level}$
2. Select the [I-Mark Slice Level] in the [Calibrate] menu and press the  button.
3. Press the  /  buttons to change the [Slice level] value. Set the [Slice level] to the slice level calculated in step 1.
4. Press the  button to confirm the value.



- If you set the [Slice level] to 0.0 (V), the product sets the slice level automatically.

[Head Check]

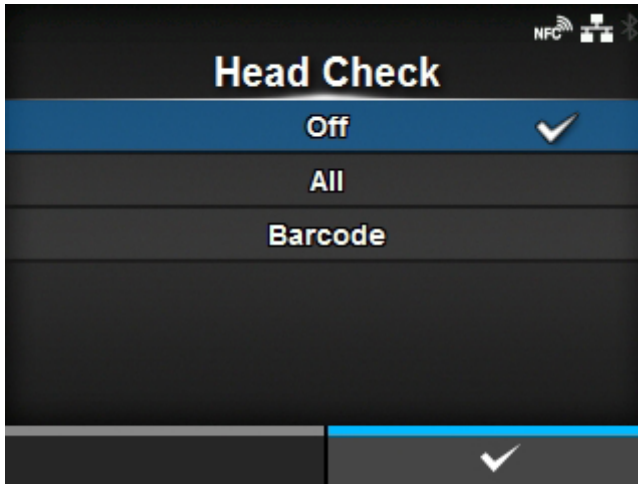

Automatically check if there is a broken element of the print head.

The options are as follows:

Off

Disable the Head Check.

All

Check the entire print area.

Barcode

Check only the area for printing a barcode. Head check is not applicable for barcodes printed as graphic data.



- Head check is a reference for checking for a broken element of the print head. This function does not guarantee barcode readability. A regular barcode reader test is required. When a void of printing got up, the head check function may not work immediately. Some gaps may occur.

For the outputted label after the head error, perform the scanner reader of the printed barcode to check the label.

[Head Check Mode]

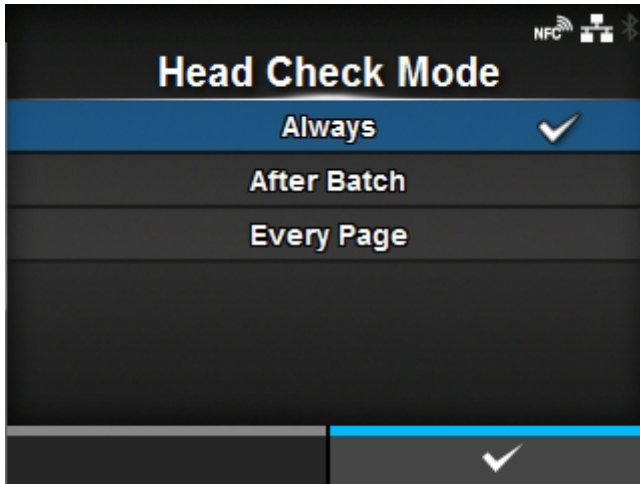

Set the method for head check.

Appears if you have selected [All] or [Barcode] in the [Head Check] menu.

The options are as follows:

Always

Perform the head check for every item.

After Batch

The head check occurs before starting to print and when printing is stopped. If backfeed is applicable, the head check occurs before starting to print, when stopping to print and during the backfeed.

Every Page

Perform the head check for each specified number of media.

[Every Page]

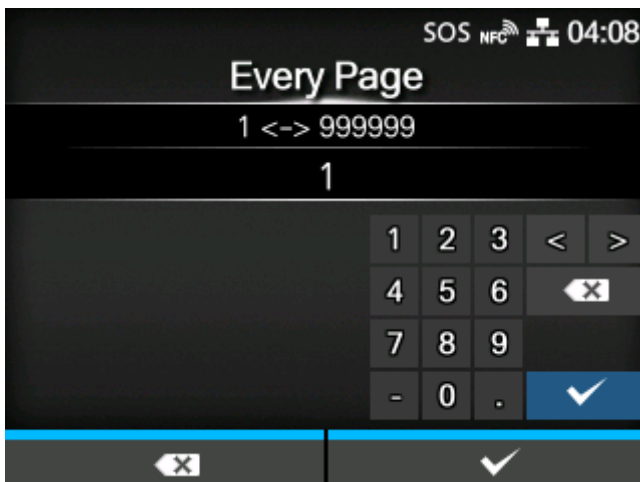

Perform the head check for each specified number of media.

Appears if you have selected [Every Page] in the [Head Check Mode] menu.

The setting range is from 1 to 999999.

[Check Media Size]

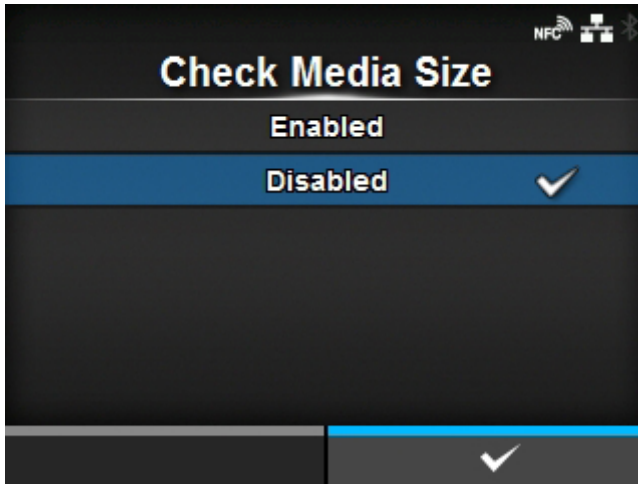

Enable or disable media size check.

Appears if you have selected [Gap] or [I-Mark] in the [Sensor Type] menu.

If this function is enabled, "Media Error" is shown when either of the following conditions applies:

- If the media is more than 3 mm (0.12") longer than the media length specified with the media size command ESC+A1.
- If the current media feed length is more than 3 mm (0.12") longer than the media length fed for the first time after this function is enabled.

The options are as follows:

Enabled

Enable media size check.

Disabled

Disable media size check.



- If you have selected [Cut & Print] in the [Print Mode] menu, media errors do not occur.
-

[Adjustments]

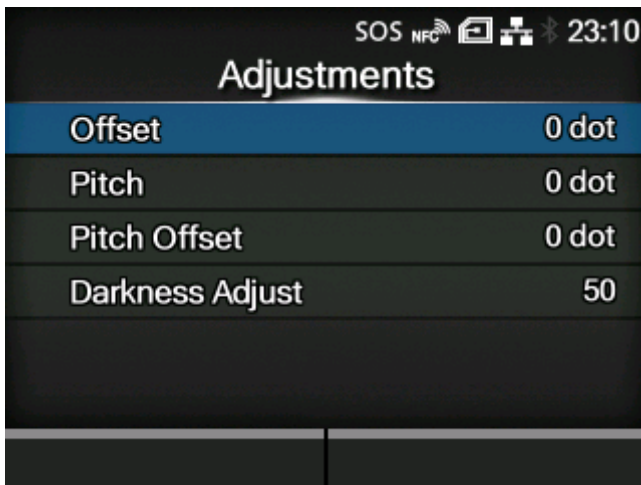

Correct the offset position, print position and print darkness.

The setting items are as follows:

[Offset](#)

Adjusts the backfeed/stop position for Tear-off/Cut/Dispense operation.

[Pitch](#)

Adjusts the print start position thus effects the vertical print position placement.

[Pitch Offset](#)

Adjusts the offset position and the pitch position at the same time.

[Darkness Adjust](#)

Fine tune the print darkness.

[Offset]



Correct the offset position.

Offset adjusts the backfeed/stop position for Tear-off/Cut/Dispense operation.

Set the value '+' to move the offset position in the direction opposite to the feed direction and '-' to move in the feed direction.

The setting range varies depending on the print resolution of the product.

The setting range is as follows:

Resolution	CL4NX Plus	CL6NX Plus
203 dpi (1 dot = 0.125 mm (0.0049"))	-30 to 0 to 30 dots	-30 to 0 to 30 dots
305 dpi (1 dot = 0.083 mm (0.0033"))	-45 to 0 to 45 dots	-45 to 0 to 45 dots
609 dpi (1 dot = 0.042 mm (0.0017"))	-90 to 0 to 90 dots	-

[Pitch]

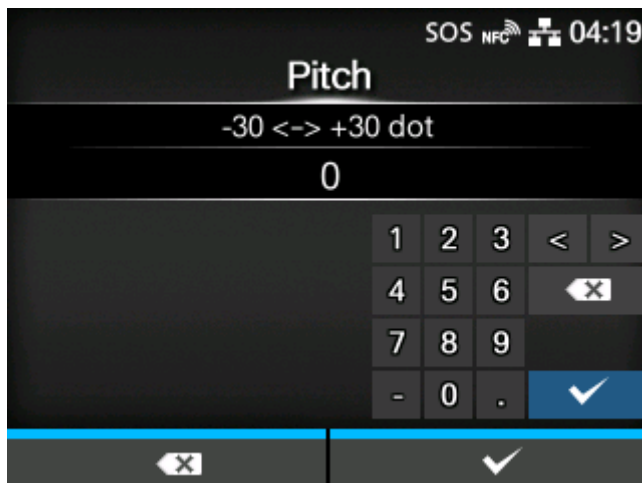

Pitch adjusts the print start position thus effects the vertical print position placement.

Set the value '+' to move print position in the direction opposite to the feed direction and '-' to move in the feed direction.

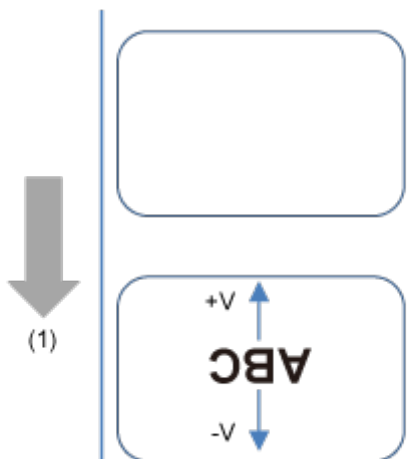

(1) Feed direction

The setting range varies depending on the print resolution of the product.

The setting range is as follows:

Resolution	CL4NX Plus	CL6NX Plus
203 dpi (1 dot = 0.125 mm (0.0049"))	-30 to 0 to 30 dots	-30 to 0 to 30 dots
305 dpi (1 dot = 0.083 mm (0.0033"))	-45 to 0 to 45 dots	-45 to 0 to 45 dots
609 dpi (1 dot = 0.042 mm (0.0017"))	-90 to 0 to 90 dots	-

[Pitch Offset]

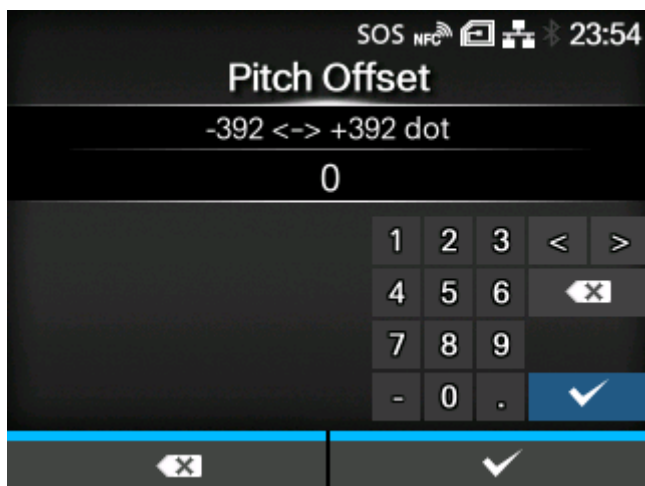

Pitch Offset adjusts the offset position and the pitch position at the same time.

Set the value '+' to move the offset and pitch positions in the direction opposite to the feed direction and '-' to move in the feed direction.

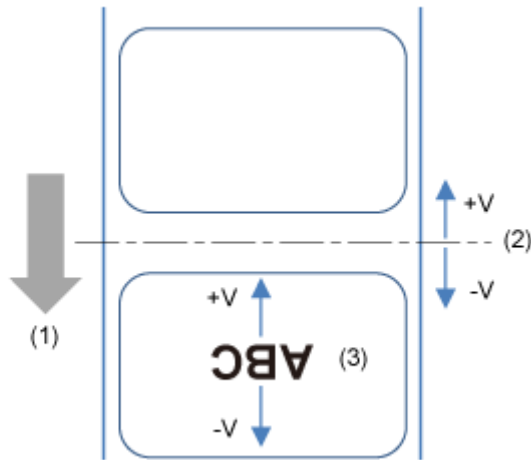

- (1) Feed direction
- (2) Offset position (backfeed/stop position for Tear-off/Cut/Dispense operation)
- (3) Pitch position (leading edge of media position that decides the vertical print position)

The setting range varies depending on the print resolution of the product.

The setting range is as follows:

Resolution	CL4NX Plus	CL6NX Plus
203 dpi (1 dot = 0.125 mm (0.0049"))	-392 to 0 to 392 dots	-392 to 0 to 392 dots
305 dpi (1 dot = 0.083 mm (0.0033"))	-588 to 0 to 588 dots	-588 to 0 to 588 dots
609 dpi (1 dot = 0.042 mm (0.0017"))	-1176 to 0 to 1176 dots	-



- When you have selected [Cutter] in the [Print Mode] menu, and you increase this setting value in the '-' direction, some unnecessary labels may feed. In this case, set a slower print speed.

[Darkness Adjust]

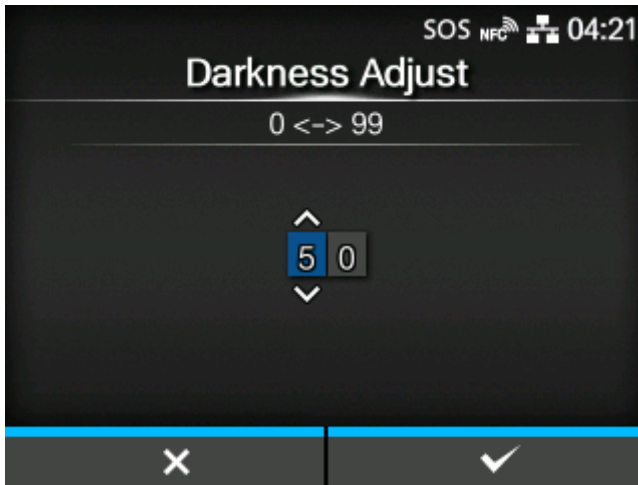

Fine tune the print darkness.
The setting range is from 0 to 99.
0 is the lightest and 99 is the darkest.

[Start Online]

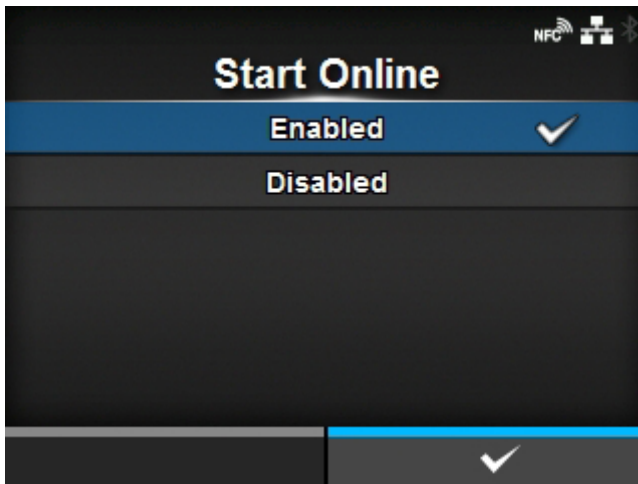

Select default mode when the product is powered on.
The options are as follows:
Enabled
The product powers on in Online mode.
Disabled
The product powers on in Offline mode.

[Feed After Error]

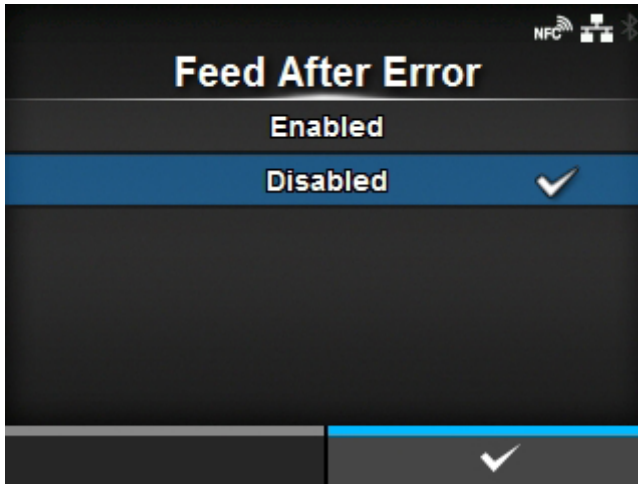

Set whether to automatically feed the media when recovering from an error and changing to Online mode.

The options are as follows:

Enabled

Feed the media when changing to Online mode after recovering from an error.

Disabled

Do not feed the media when changing to Online mode after recovering from an error.

However, if [Feed At Power On] is set to [Enabled], the product feeds the media when it is powered on and changes to Online mode.

[Feed At Power On]

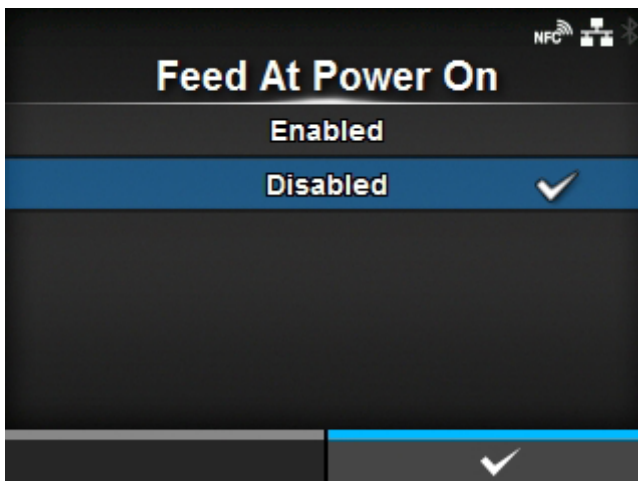

Set whether to automatically feed the media when the product is powered on.

The options are as follows:

Enabled

Feed the media when the product is powered on.

Disabled

Do not feed the media when the product is powered on.

However, if [Feed After Error] is set to [Enabled], the product feeds the media when it is powered on and changes to Online mode.

[Finisher Feed]

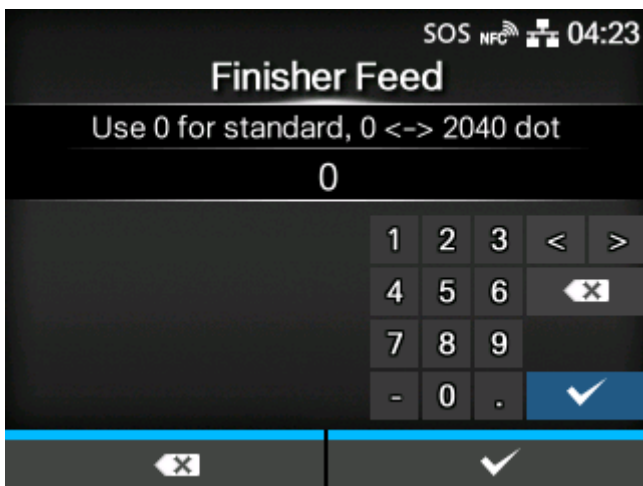

Set the media feed amount for Tear-off, cut and dispense stop. Set the media feed amount based on the print head position of 0.

The actual media feed amount is the value of [Offset] + [Finisher Feed].

The setting range varies depending on the print resolution of the product.

The setting range is as follows:

Resolution	CL4NX Plus	CL6NX Plus
203 dpi (1 dot = 0.125 mm (0.0049"))	0 to 2040 dots	0 to 2040 dots
305 dpi (1 dot = 0.083 mm (0.0033"))	0 to 3060 dots	0 to 3060 dots
609 dpi (1 dot = 0.042 mm (0.0017"))	0 to 6120 dots	-



- When [Printing Mode] is set to [Use Ribbon], the length of label backfeed needs to be under 30 mm (1.18"). If it is over 30 mm (1.18"), the end of the ribbon may be falsely detected.
- A message prompting you to restart the product will appear on the Online/Offline screen if you have made any changes. In such a case, reboot the product to apply the settings.

[Paper End]

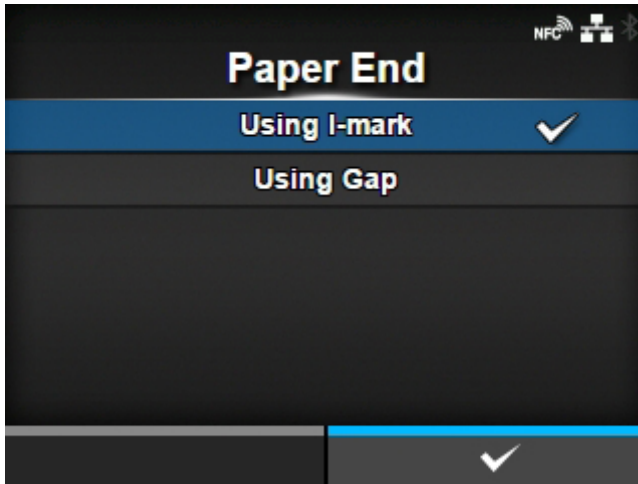

Select the sensor for sensing the paper end.

The options are as follows:

Using I-mark

Use the I-mark sensor (reflective type) to detect the paper end.

Using Gap

Use the Gap sensor (transmissive type) to detect the paper end.

[Head Base Position]

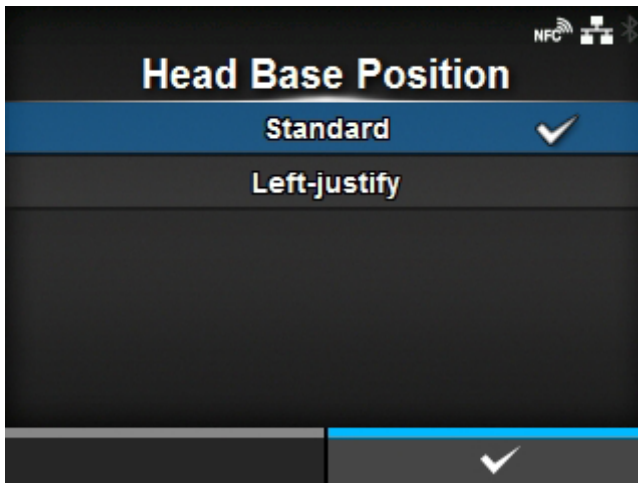

Set the position used for the base reference point for printing.

The options are as follows:

Item	CL4NX Plus	CL6NX Plus
[Standard]	Print with a standard base reference point.	Print with a standard base reference point.

Item	CL4NX Plus	CL6NX Plus
[Left-justify]	Move the base reference point 2 mm (0.08") to the left toward the product.	Expand the width of the printable area (maximum print width) to 167.5 mm (6.59"). Move the base reference point 2 mm (0.08") to the left toward the product.



- A message prompting you to restart the product will appear on the Online/Offline screen if you have made any changes. In such a case, reboot the product to apply the settings.

[Prioritize]

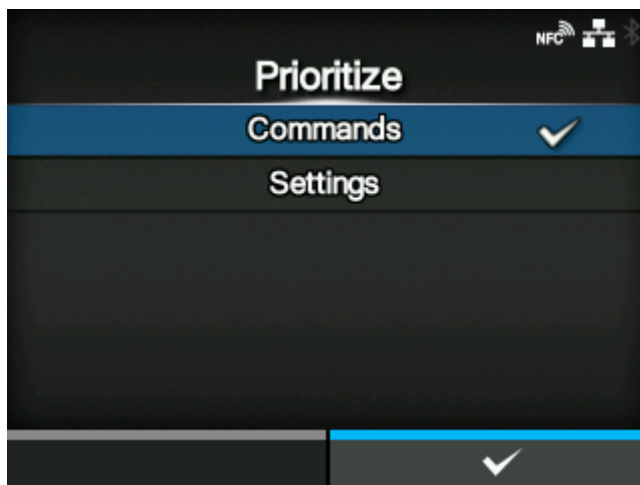

For product settings, set whether to prioritize the settings that are done through the product or through commands.

The options are as follows:

Commands

Prioritize the settings through commands.

Settings

Prioritize the settings that are done through the product.

[Reprint]

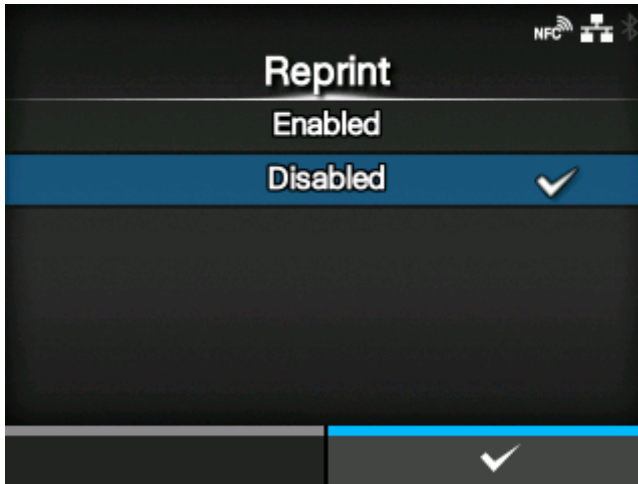

Enable or disable the reprint function.

The options are as follows:

Enabled

Enable the reprint function.

Disabled

Disable the reprint function.

If you have selected [Enabled] in [Reprint], you can press the  button ([REPRINT]) on the Online screen to print the previous data again.



- The previous data will be lost if you power off the product.

[Print End Position]



Adjust the media stop position or cut position when the [Sensor Type] is set to [None]. This adjustment also sets the blank amount from the media stop position.

The setting range varies depending on the print resolution of the product.

The setting range is as follows:

Resolution	CL4NX Plus	CL6NX Plus
203 dpi (1 dot = 0.125 mm (0.0049"))	0 to 20000 dots	0 to 20000 dots
305 dpi (1 dot = 0.083 mm (0.0033"))	0 to 18000 dots	0 to 18000 dots
609 dpi (1 dot = 0.042 mm (0.0017"))	0 to 9600 dots	-

[Label Near End]

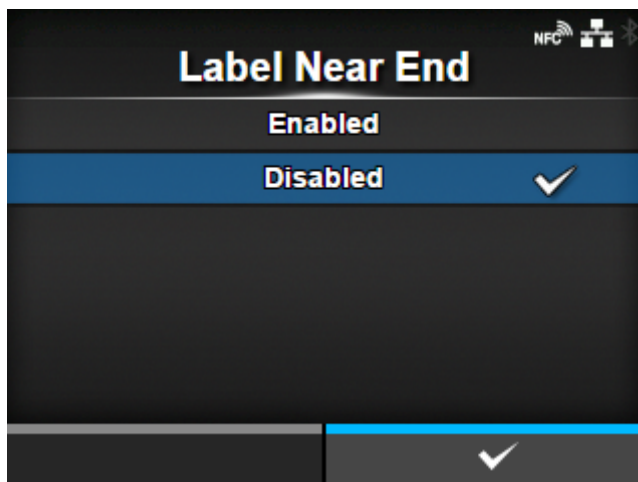

Shows or does not show the warning icon when the media is about to run out. Printing does not stop even if the warning icon shows up.

The options are as follows:

Enabled

Shows the warning icon.

Disabled

Does not show the warning icon.



- The warning icon is shown in the status bar on the upper part of the screen.



[Interface] Menu

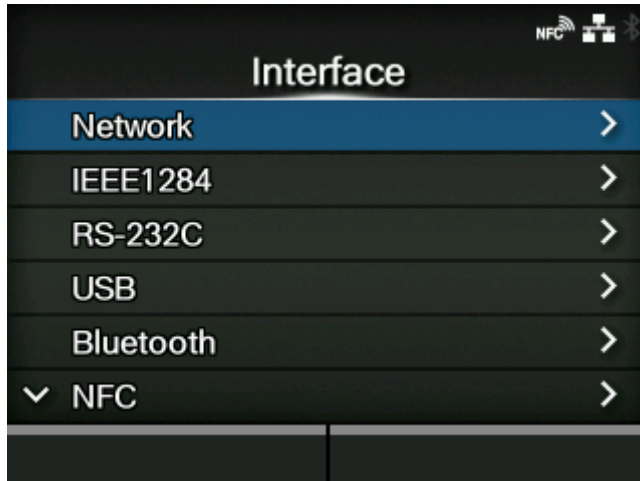

The following settings are available in the [Interface] menu:

[Network](#)

Set the LAN connection and wireless LAN connection.

[IEEE1284](#)

Set the IEEE1284 connection.

- Appears only if the combo interface board is installed.

[RS-232C](#)

Set the RS-232C connection.

- Appears only if the combo interface board is installed.

[USB](#)

Set the USB connection.

[Bluetooth](#)

Set the Bluetooth connection.

[NFC](#)

Set the NFC connection.

[Ignore CR/LF](#)

Set to ignore CR/LF codes.

[Ignore CAN/DLE](#)

Set to ignore CAN/DLE codes.

[External I/O](#)

Set the external signal (EXT).

- Appears only if the combo interface board is installed.

[RFID \(RFID Models Only\)](#)

Set the RFID.

- Appears only for the RFID model.

[Network]

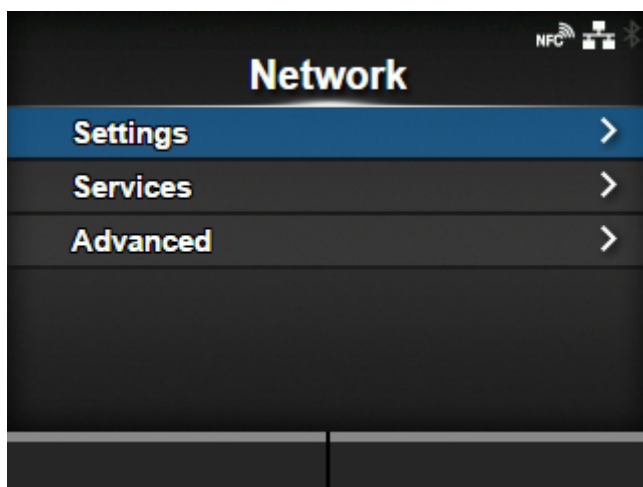

This menu is for using LAN and wireless LAN for the interface between the computer and the product.

The setting items are as follows:

[Settings](#)

Set LAN or wireless LAN, or select an interface.

[Services](#)

Set the TCP/IP port number, NTP, LPD, FTP, SNMP, or SOS (SATO Online Services).

[Advanced](#)

Set the advanced function for the interface.

[Settings]

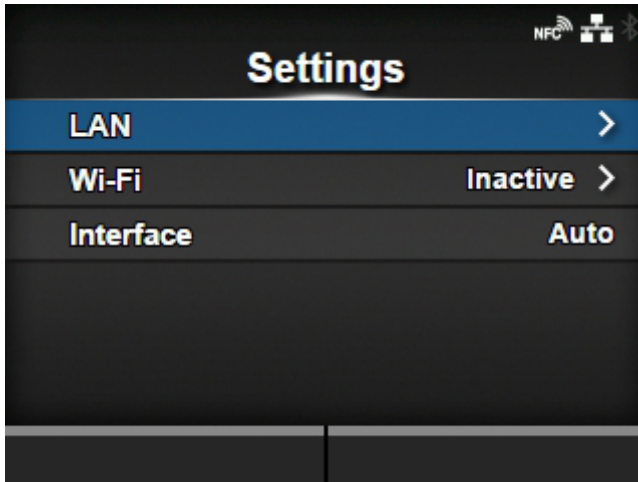

Set the LAN or wireless LAN, or select the interface.

The setting items are as follows:

[LAN](#)

Set the LAN.

[Wi-Fi](#)

Set the wireless LAN.

- Appears only if you have installed the optional wireless LAN.

[Interface](#)

Select the network interface.

- This item is to select the network interface from LAN or wireless LAN when you have installed the optional wireless LAN.



- You cannot use LAN and wireless LAN at the same time. The wireless LAN function is available only if you have installed the wireless LAN.
-

[LAN]

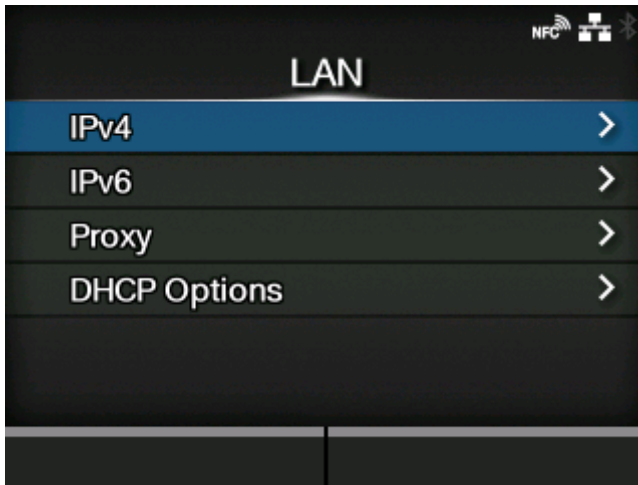

Set the IPv4, IPv6 or proxy for the LAN.

The setting items are as follows:

[IPv4](#)

Set the IPv4 for the LAN.

[IPv6](#)

Set the IPv6 for the LAN.

[Proxy](#)

Set the proxy for the LAN.

[DHCP Options](#)

Set the DHCP options for the LAN.

[IPv4]

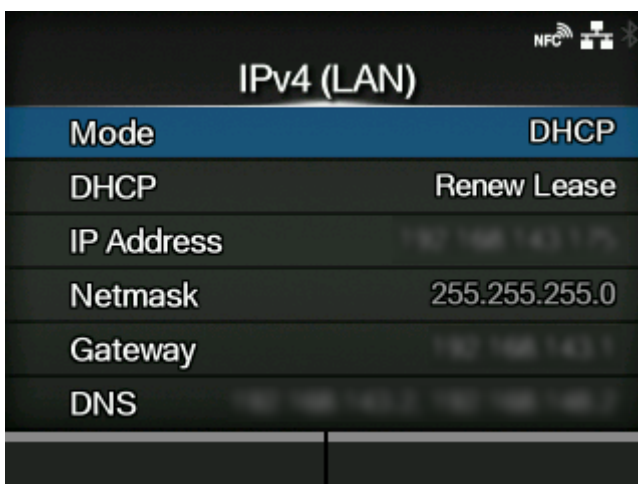

Set IPv4 for the LAN.

The setting items are as follows:

[Mode](#)

Select the IP address assignment method.

DHCP / Renew Lease

Update the lease time and get the IP address from the DHCP server again.

- Appears only if you have selected [DHCP] in the [Mode] menu and LAN is the active interface.
- Does not appear if the wireless LAN is the active interface.

IP Address

Set and check the IP address.

If you have selected [DHCP] in the [Mode] menu, the screen shows the IP address you received from the DHCP server.

If you have selected [Static] in the [Mode] menu, select this to set the IP address.

Netmask

Set and check the subnet mask address.

If you have selected [DHCP] in the [Mode] menu, the screen shows the subnet mask address you received from the DHCP server.

If you have selected [Static] in the [Mode] menu, select this to set the subnet mask address.

Gateway

Set and check the default gateway address.

If you have selected [DHCP] in the [Mode] menu, the screen shows the gateway address you received from the DHCP server.

If you have selected [Static] in the [Mode] menu, select this to set the default gateway address.

DNS

Set and check DNS server addresses.

If you have selected [Static] in the [Mode] menu, select this to set and check DNS server addresses.



- After doing the settings, press the  button to enable the new settings. Press the  button to cancel the new settings and return to the previous settings.



- You cannot change [IP Address], [Netmask], [Gateway], or [DNS] when [Mode] is [DHCP].
-

[Mode]

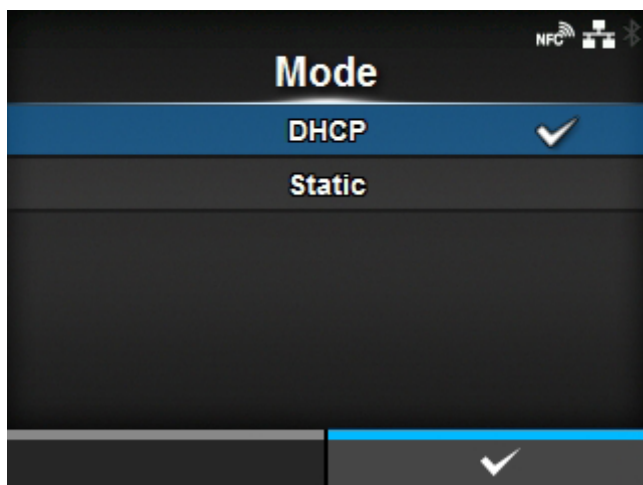

Select the IP address assignment method.

The options are as follows:

DHCP

Automatically retrieve the IP address, gateway and subnet mask from the DHCP server.

Static

Manually set the IP address, gateway and subnet mask.

[IP Address]



If you have selected [Static] in the [Mode] menu, set the IP address.

The setting range is as follows:

000.000.000.000 to 255.255.255.255

[Netmask]

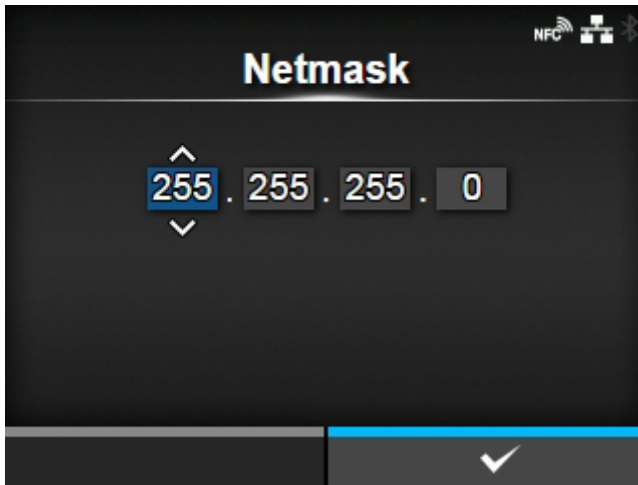

If you have selected [Static] in the [Mode] menu, set the subnet mask address.

Each group of the address can be set cyclically among 0, 128, 192, 224, 240, 248, 252, 254 and 255.

The setting range is as follows:

128.000.000.000 to 255.255.255.254

[Gateway]

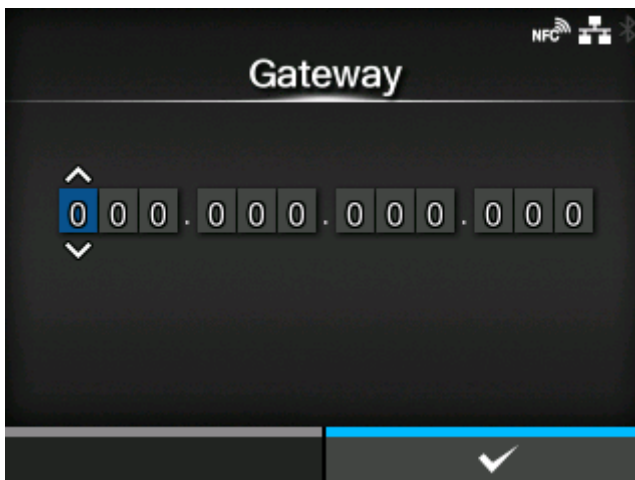

If you have selected [Static] in the [Mode] menu, set the default gateway address.

The setting range is as follows:

000.000.000.000 to 255.255.255.255

[DNS]

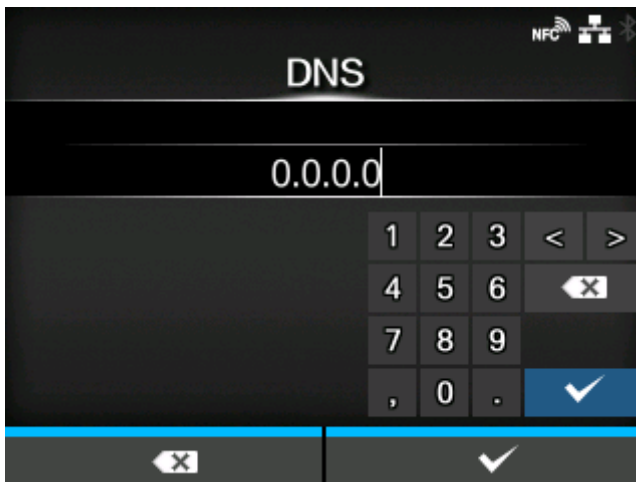

If you have selected [Static] in the [Mode] menu, set and check DNS server addresses.

The setting range is as follows:

000.000.000.000 to 255.255.255.255



- You can register up to three IP addresses for the DNS server. Use a comma to delimit different IP addresses.

[IPv6]

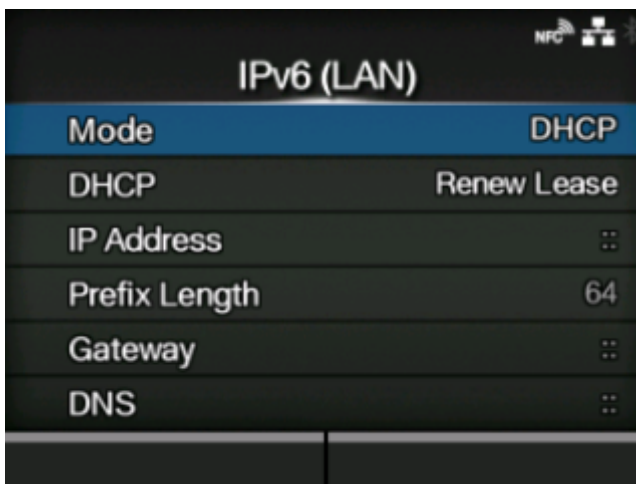

Set the IPv6 for the LAN.

The setting items are as follows:

Mode

Select the IP address assignment method or disable IPv6.

DHCP / Renew Lease

Update the lease time and get the IP address from the DHCP server again.

- Appears only if you have selected [DHCP] in the [Mode] menu.
- Does not appear if the wireless LAN is the active interface.

[IP Address](#)

Set and check the IP address.

If you have selected [DHCP] in the [Mode] menu, the screen shows the IP address you received from the DHCP server.

If you have selected [Static] in the [Mode] menu, select this to set the IP address.

[Prefix Length](#)

Set and check the prefix.

[Gateway](#)

Set and check the default gateway address.

If you have selected [DHCP] in the [Mode] menu, the screen shows the gateway address you received from the DHCP server.

If you have selected [Static] in the [Mode] menu, select this to set the default gateway address.

[DNS](#)

Set and check the address of the primary DNS server.

If you have selected [Static] in the [Mode] menu, select to set the primary address of the DNS server.



- After doing the settings, press the  button to enable the new settings. Press the  button to cancel the new settings and return to the previous settings.
-



- You cannot change [IP Address], [Prefix Length], [Gateway], or [DNS] if [Mode] is anything other than [Static].
-

[\[Mode\]](#)

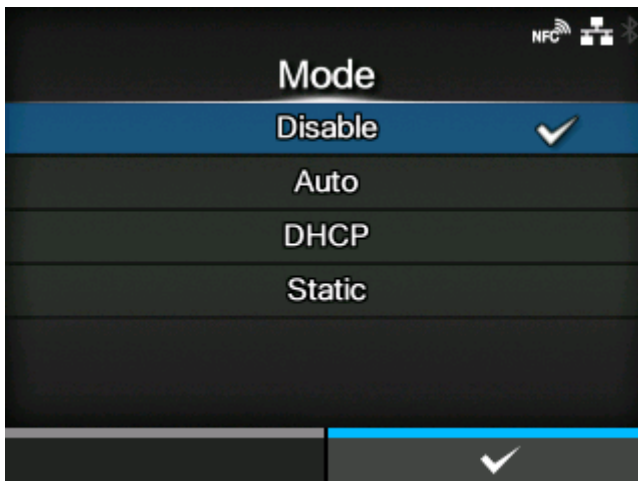

Select the IP address assignment method or disable IPv6.

The options are as follows:

[Disable](#)

Disable IPv6.

Auto

Automatically generate the IP address and gateway (stateless mode).

DHCP

Automatically retrieve the IP address and gateway from the DHCP server (stateful mode).

Static

Manually set the IP address, gateway and prefix length.

[IP Address]

If you have selected [Static] in the [Mode] menu, set the IP address.

The setting range is as follows:

0:0:0:0:0:0:1 to ffff:ffff:ffff:ffff:ffff:ffff:ffff

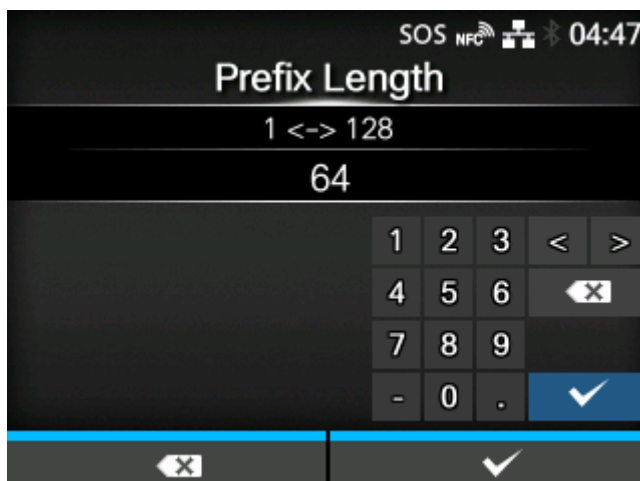
[Prefix Length]

If you have selected [Static] in the [Mode] menu, set the prefix.

The setting range is from 1 to 128.

[Gateway]

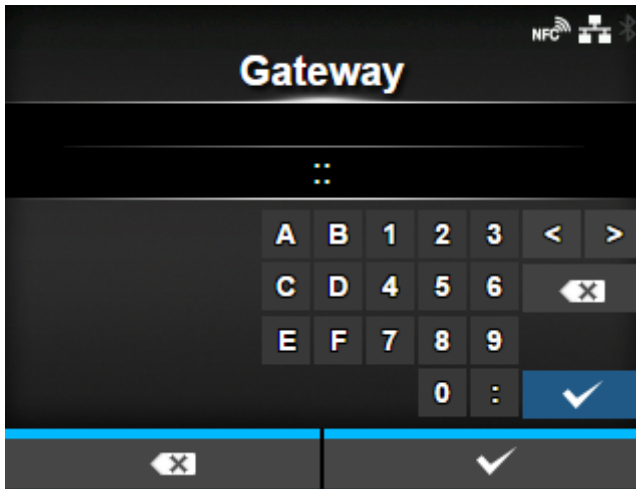

If you have selected [Static] in the [Mode] menu, set the default gateway address.

The setting range is as follows:

0:0:0:0:0:0:0 to ffff:ffff:ffff:ffff:ffff:ffff:ffff

[DNS]

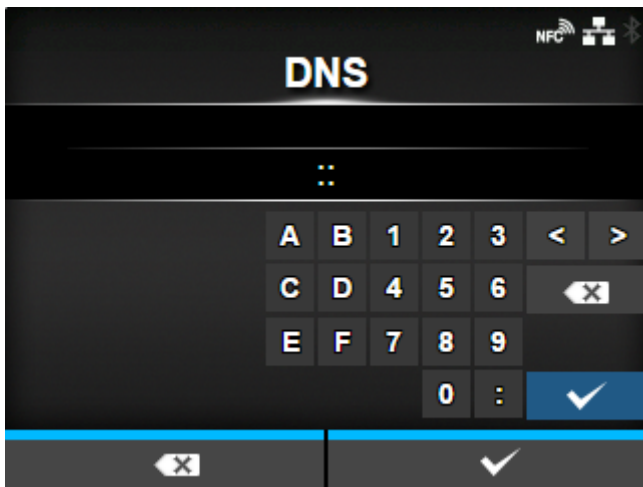

If you have selected [Static] in the [Mode] menu, set the primary address of the DNS server.

The setting range is as follows:

0:0:0:0:0:0:0 to ffff:ffff:ffff:ffff:ffff:ffff:ffff



- You can register only one IP address for the DNS server for IPv6.
-

[Proxy]

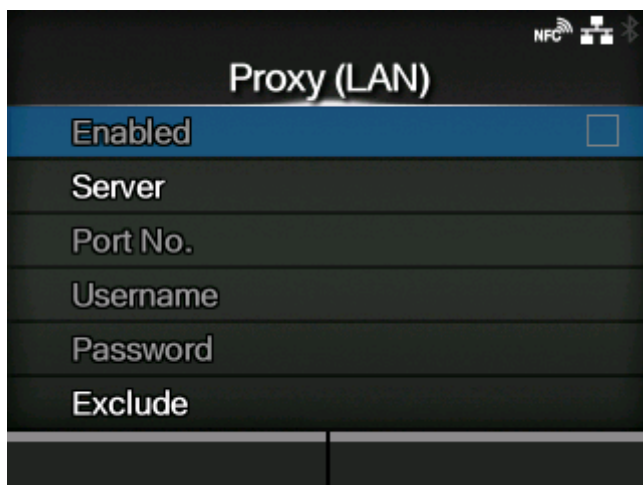

Set the proxy for the LAN.

The setting items are as follows:

[Enabled](#)

Enable or disable use of proxy.

If you have set items in the [Server] and [Exclude] menu, you can change this item.

[Server](#)

Set the proxy server address.

[Port No.](#)

Set the port number to allow communication.

If you have set the address of the proxy server in the [Server] menu, select this to set the port number.

[Username](#)

Set the username if you need a username to connect to the proxy server.

If you have set the address of the proxy server in the [Server] menu, select this to set the username.

[Password](#)

Set the password if you need a password to connect to the proxy server.

If you have set the address of the proxy server in the [Server] menu, select this to set the password.

[Exclude](#)

Exclude the proxy from usage.

[Enabled]

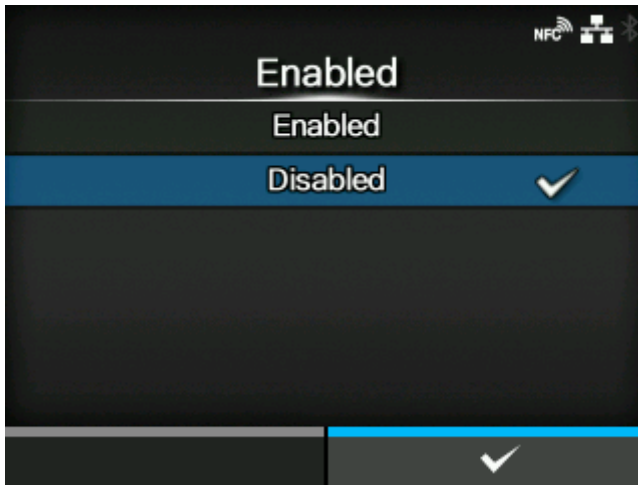

Enable or disable use of proxy.

The options are as follows:

Enabled

Enable proxy server usage.

Disabled

Disable proxy server usage.



- To enable the proxy, [Server] should be set and [Exclude] must contain at least 127.0.0.1 and localhost.
-

[Server]

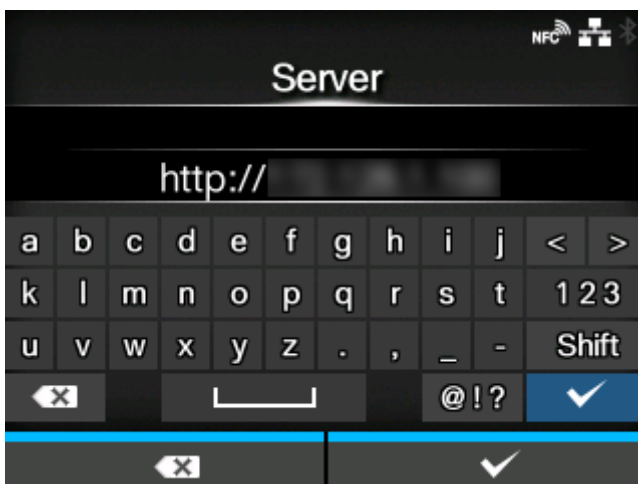

Set the name or IP address of the proxy server.

Example of input) 172.128.1.100



- Server should be set with a valid name or IP address.
-

[Port No.]

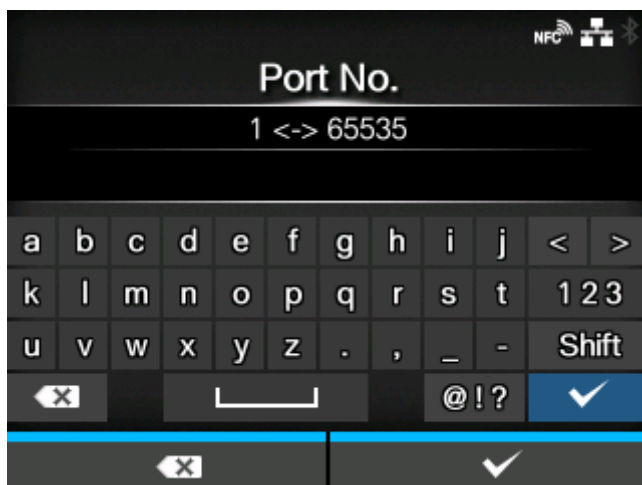

Set the port number that allows communication with the proxy server.

The setting range is from 1 to 65535.



- Set a port number not used by other services. If port numbers that overlap with those used by other services are used, communication cannot be performed properly.

[Username]

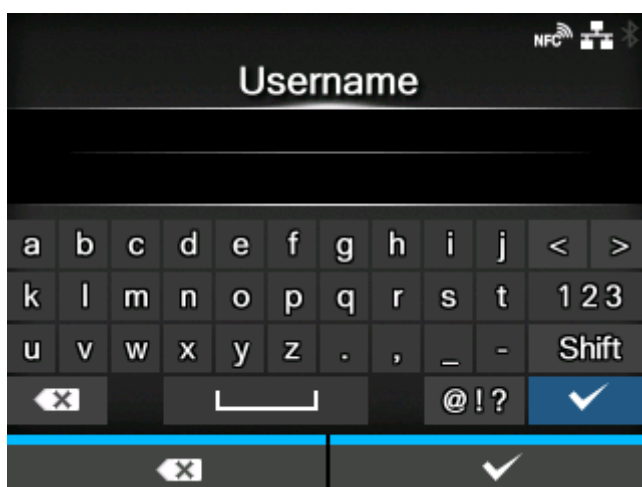

Set the username if you need a username to connect to the proxy server.

You can enter 1 to 8 characters. Alphabets (capital and small letters) and numbers can be used.

[Password]

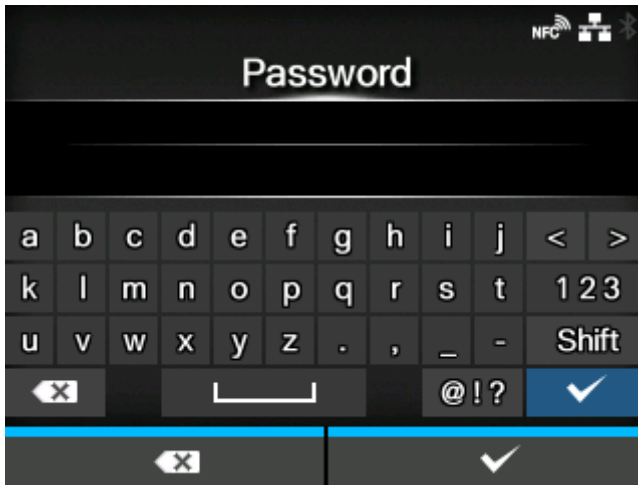

Set the password if you need a password to connect to the proxy server.

You can enter 1 to 16 characters. Alphabets (capital and small letters), numbers and symbols can be used.



- Some symbols cannot be used. If you enter a symbol that cannot be used, [Invalid value] appears on the screen.

[Exclude]

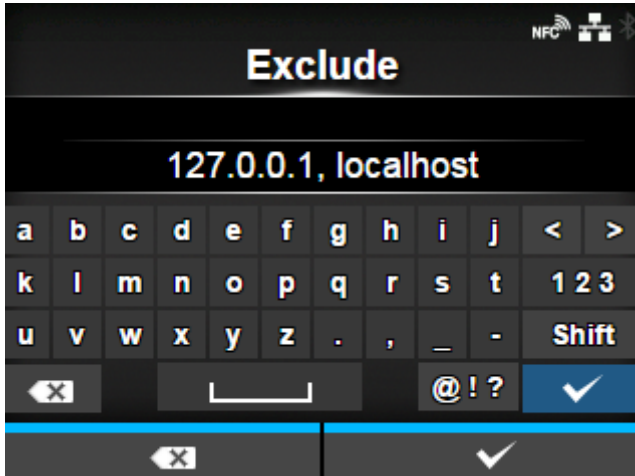

Set names, IP addresses or domains for the proxy to exclude.



- Exclude must contain at least 127.0.0.1 and localhost.

[DHCP Options]

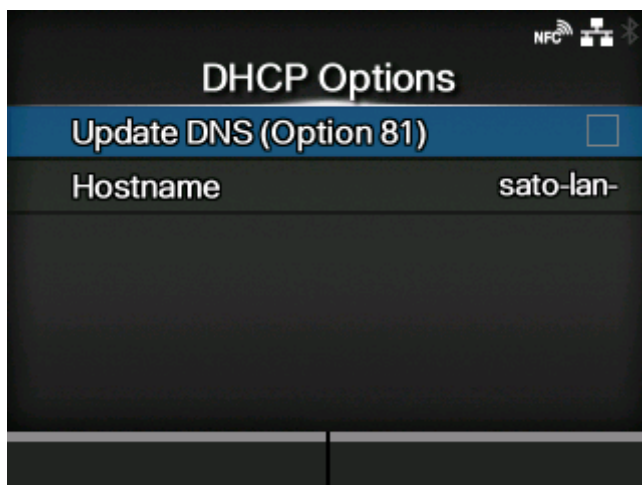

Set the DHCP options for the LAN.

[DHCP Options] can be set only if you have selected [DHCP] in the [IPv4] > [Mode] menu or [IPv6] > [Mode] menu.

The setting items are as follows:

[Update DNS \(Option 81\)](#)

Enables or disables the use of DHCP server option 81.

[Hostname](#)

Set the hostname.

[Update DNS (Option 81)]

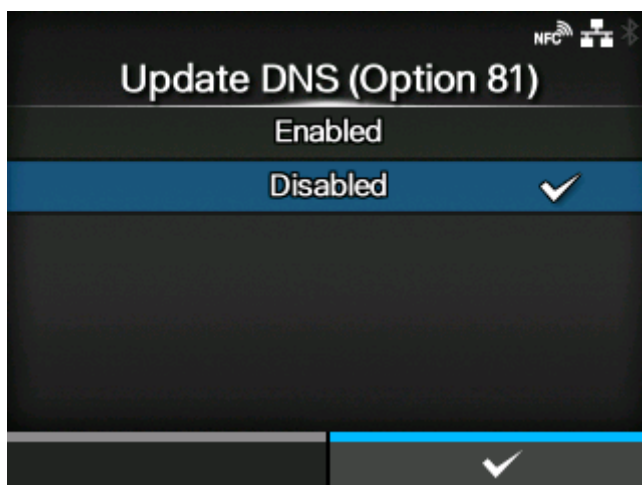

Enable or disable the use of DHCP server option 81.

The options are as follows:

[Enabled](#)

Enable the use of DHCP server option 81.

Disabled

Disable the use of DHCP server option 81.

[Hostname]



Set the hostname.

You can enter 0 to 255 characters. Alphabets (capital and small letters), numbers and symbols can be used.

[Wi-Fi]

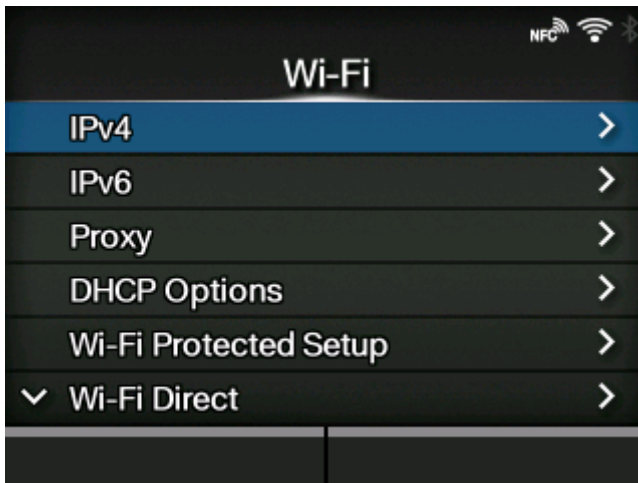

Set the wireless LAN.

Appears only if you have installed the optional wireless LAN.

The setting items are as follows:

[IPv4](#)

Configure IPv4 for Wi-Fi.

[IPv6](#)

Configure IPv6 for Wi-Fi.

[Proxy](#)

Configure the proxy for Wi-Fi.

[DHCP Options](#)

Configure the DHCP options for Wi-Fi.

[Wi-Fi Protected Setup](#)

Set the wireless LAN connection with the Wi-Fi Protected Setup (WPS) function.

[Wi-Fi Direct](#)

Set the Wi-Fi Direct function.

- Enabled only if you have selected [Infrastructure] in the [Mode] menu.

[Band](#)

Set the band.

- Enabled only if you have selected [Infrastructure] in the [Mode] menu.

[SSID](#)

Set the SSID.

[Hidden SSID](#)

Set the hidden SSID.

- Appears only if you have selected [Infrastructure] in the [Mode] menu.

[Mode](#)

Set the communication mode.

[Channel](#)

Set the communication channel.

[Security](#)

Set the security (encryption method).

[WEP Conf.](#)

Set the WEP key.

- Appears only if you have selected [WEP] in the [Security] menu.

[WPA Conf.](#)

Set the WPA authentication.

- Appears only if you have selected [WPA2/WPA] or [WPA2] in the [Security] menu.

[EAP Conf.](#)

Set the EAP authentication.

- Appears only if you have selected [Dynamic WEP] in the [Security] menu.



- After doing the settings, press the  button to enable the new settings. Press the  button to cancel the new settings and return to the previous settings.



- When [Wi-Fi Direct] is active, [IPv6] and [Wi-Fi Protected Setup] do not appear on the screen.

[IPv4]

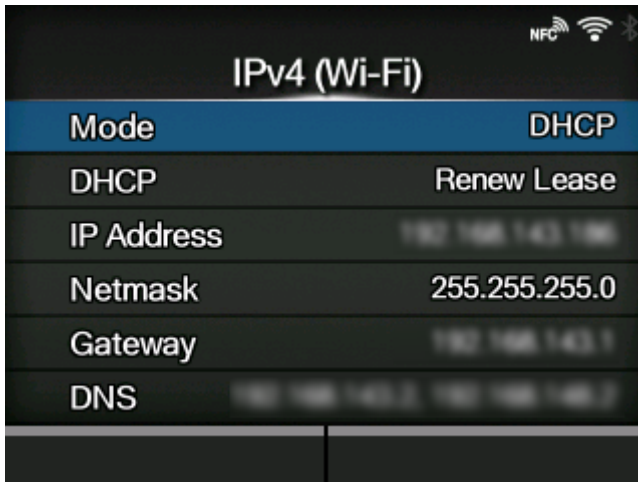

Configure IPv4 for Wi-Fi.

The setting items are as follows:

Mode

Select the IP address assignment method.

DHCP / Renew Lease

Update the lease time and get the IP address from the DHCP server again.

- Appears only if you have selected [DHCP] in the [Mode] menu.
- Does not appear if LAN is the active interface.

IP Address

Set and check the IP address.

If you have selected [DHCP] in the [Mode] menu, the screen shows the IP address you received from the DHCP server.

If you have selected [Static] in the [Mode] menu, select to set the IP address.

Netmask

Set and check the subnet mask address.

If you have selected [DHCP] in the [Mode] menu, the screen shows the subnet mask address you received from the DHCP server.

If you have selected [Static] in the [Mode] menu, select to set the subnet mask address.

Gateway

Set and check the default gateway address.

If you have selected [DHCP] in the [Mode] menu, the screen shows the gateway address you received from the DHCP server.



If you have selected [Static] in the [Mode] menu, select to set the default gateway address.

DNS

Set and check DNS server addresses.

If you have selected [Static] in the [Mode] menu, select to set and check DNS server addresses.



- After doing the settings, return to the [Wi-Fi] screen by pressing the  button, and then press the  button to enable the new settings. Press the  button to cancel the new settings and return to the previous settings.



- When [Wi-Fi Direct] is active, [Mode], [DHCP] and [DNS] do not appear. In addition, you cannot change [IP Address], [Netmask], or [Gateway] if [DHCP] or [Wi-Fi Direct] is active. [DNS] cannot be changed if [Mode] is [DHCP].

[Mode]

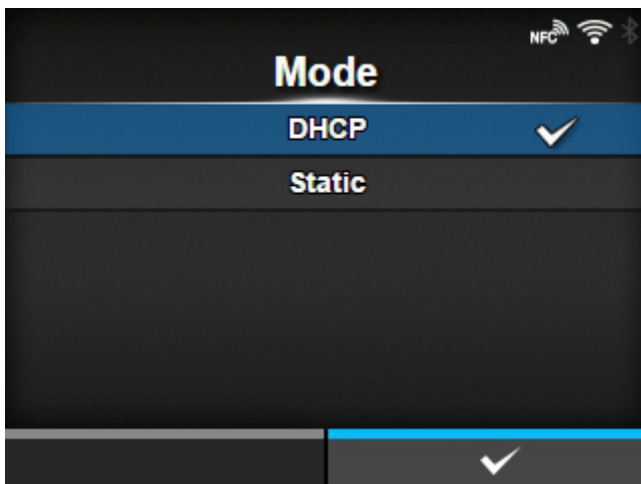

Select the IP address assignment method.

The options are as follows:

DHCP

Automatically retrieve the IP address, gateway and subnet mask from the DHCP server.

Static

Manually set the IP address, gateway and subnet mask.

[IP Address]



If you have selected [Static] in the [Mode] menu, set the IP address.

The setting range is as follows:

000.000.000.000 to 255.255.255.255

[Netmask]

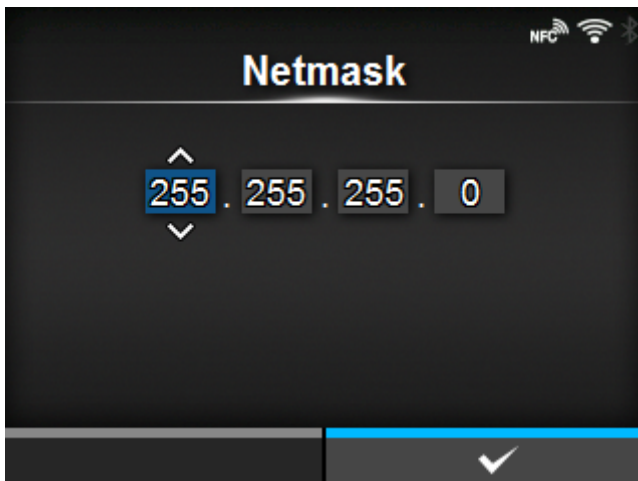

If you have selected [Static] in the [Mode] menu, set the subnet mask address.

Each group of the address can be set cyclically among 0, 128, 192, 224, 240, 248, 252, 254 and 255.

The setting range is as follows:

128.000.000.000 to 255.255.255.254

[Gateway]

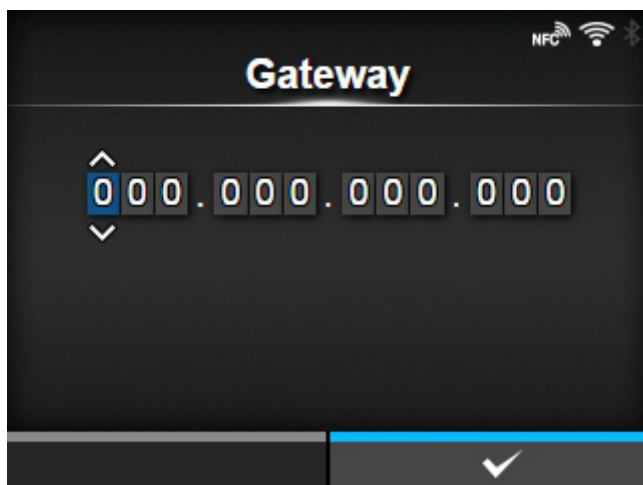

If you have selected [Static] in the [Mode] menu, set the default gateway address.

The setting range is as follows:

000.000.000.000 to 255.255.255.255

[DNS]

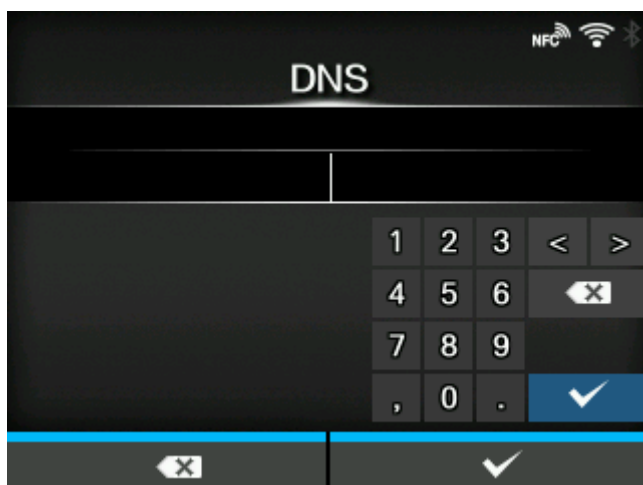

If you have selected [Static] in the [Mode] menu, set and check DNS server addresses.

The setting range is as follows:

000.000.000.000 to 255.255.255.255



- You can register up to three IP addresses for the DNS server. Use a comma to delimit different IP addresses.

[IPv6]

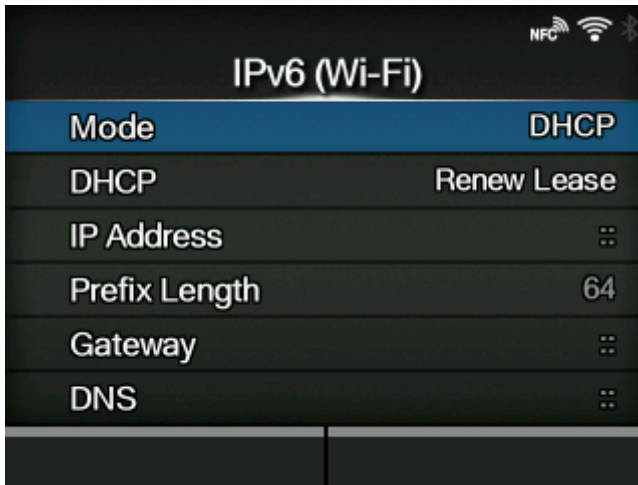

Configure IPv6 for Wi-Fi.

The setting items are as follows:

[Mode](#)

Select the IP address assignment method or disable IPv6.

[DHCP / Renew Lease](#)

Update the lease time and get the IP address from the DHCP server again.

- Appears only if you have selected [DHCP] in the [Mode] menu.
- Does not appear if LAN is the active interface.

[IP Address](#)

Set and check the IP address.

If you have selected [DHCP] in the [Mode] menu, the screen shows the IP address you received from the DHCP server.

If you have selected [Static] in the [Mode] menu, select to set the IP address.

[Prefix Length](#)

Set and check the prefix.

[Gateway](#)

Set and check the default gateway address.



If you have selected [DHCP] in the [Mode] menu, the screen shows the gateway address you received from the DHCP server.

If you have selected [Static] in the [Mode] menu, select to set the default gateway address.

[DNS](#)

Set and check the address of the primary DNS server.

If you have selected [Static] in the [Mode] menu, select to set the primary address of the DNS server.

-
- After doing the settings, return to the [Wi-Fi] screen by pressing the  button, and then press the  button to enable the new settings. Press the  button to cancel the new settings and return to the previous settings.
-

- When [Wi-Fi Direct] is active, this [IPv6] screen does not appear. In addition, you cannot change [IP Address], [Prefix Length], [Gateway], or [DNS] if [Mode] is anything other than [Static].
-

[Mode]

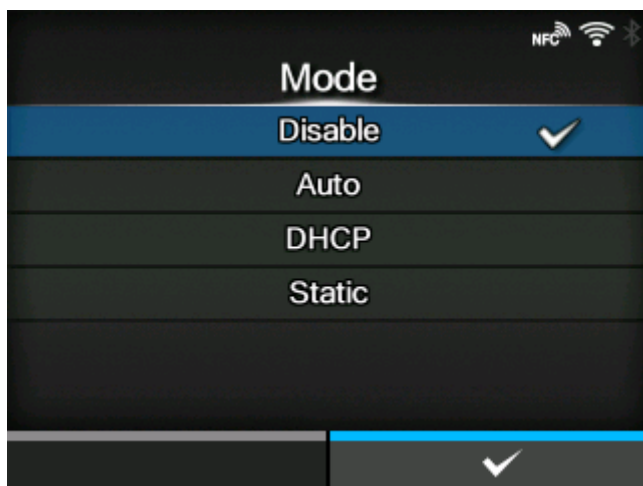

Select the IP address assignment method or disable IPv6.

The options are as follows:

Disable

Disable IPv6.

Auto

Automatically generate the IP address and gateway (stateless mode).

DHCP

Automatically retrieve the IP address and gateway from the DHCP server (stateful mode).

Static

Manually set the IP address, gateway and prefix length.

[IP Address]



If you have selected [Static] in the [Mode] menu, set the IP address.

The setting range is as follows:

0:0:0:0:0:0:1 to ffff:ffff:ffff:ffff:ffff:ffff:ffff

[Prefix Length]



If you have selected [Static] in the [Mode] menu, set the prefix.

The setting range is from 1 to 128.

[Gateway]



If you have selected [Static] in the [Mode] menu, set the default gateway address.

The setting range is as follows:

0:0:0:0:0:0:0 to ffff:ffff:ffff:ffff:ffff:ffff:ffff

[DNS]

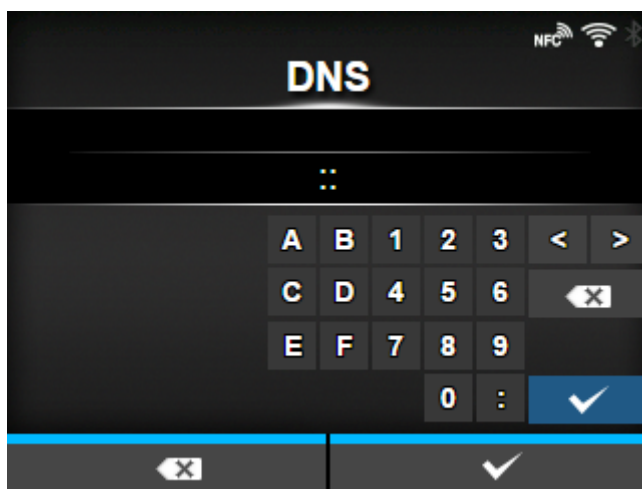

If you have selected [Static] in the [Mode] menu, set the primary address of the DNS server.

The setting range is as follows:

0:0:0:0:0:0:0 to ffff:ffff:ffff:ffff:ffff:ffff:ffff



- You can register only one IP address for the DNS server for IPv6.
-

[Proxy]

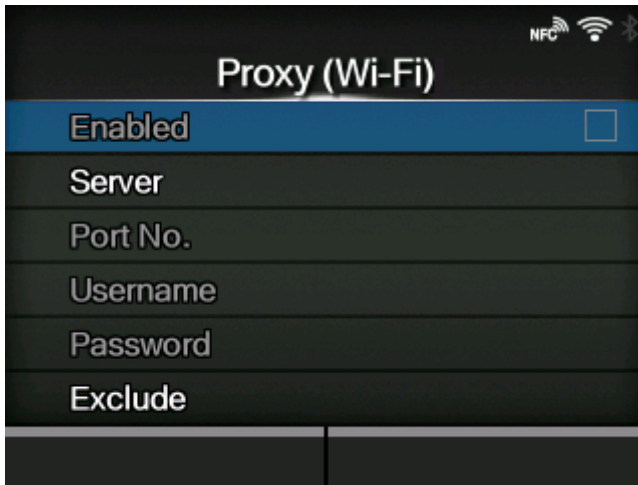

Configure the proxy for Wi-Fi.

The setting items are as follows:

[Enabled](#)

Enable or disable use of proxy.

If you have set items in the [Server] and [Exclude] menu, you can change this item.

[Server](#)

Set the proxy server address.

[Port No.](#)

Set the port number to allow communication.

If you have set the address of the proxy server in the [Server] menu, select this to set the port number.

[Username](#)

Set the username if you need a username to connect to the proxy server.

If you have set the address of the proxy server in the [Server] menu, select this to set the username.

[Password](#)

Set the password if you need a password to connect to the proxy server.

If you have set the address of the proxy server in the [Server] menu, select this to set the password.

[Exclude](#)

Exclude the proxy from usage.

[Enabled]

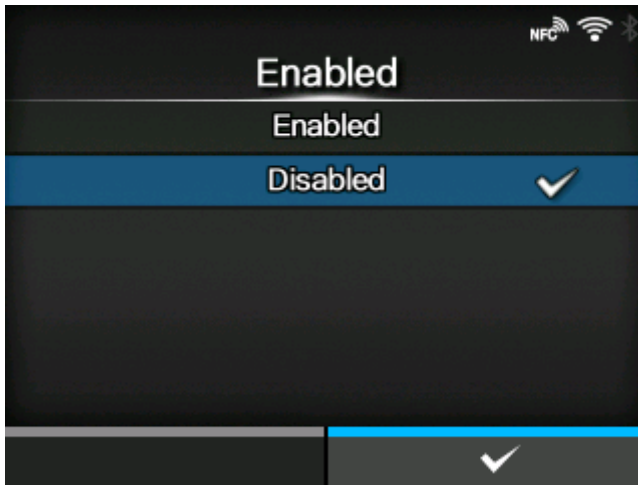

Enable or disable use of proxy.

The options are as follows:

Enabled

Enable proxy server usage.

Disabled

Disable proxy server usage.



- To enable the proxy, [Server] should be set and [Exclude] must contain at least 127.0.0.1 and localhost.
-

[Server]

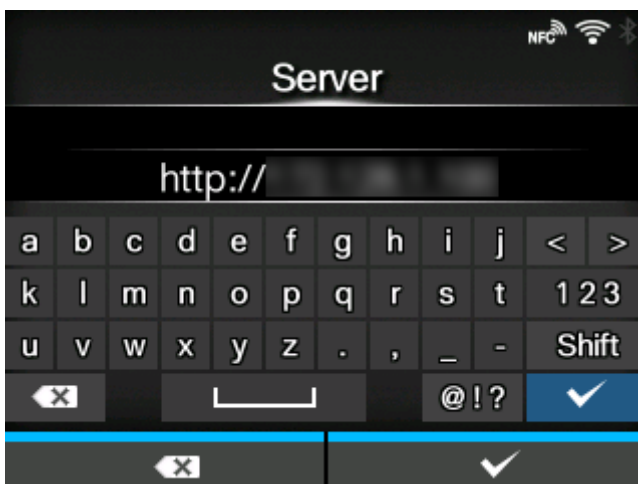

Set the name or IP address of the proxy server.

Example of input) 172.128.1.100



- Server should be set with a valid name or IP address.
-

[Port No.]

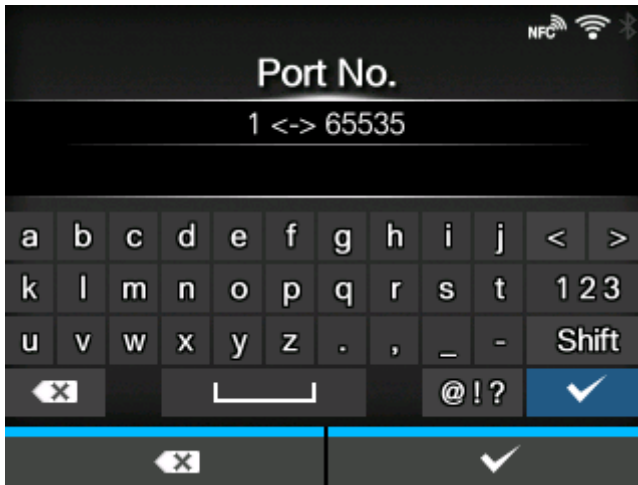

Set the port number that allows communication with the proxy server.

The setting range is from 1 to 65535.



- Set a port number not used by other services. If port numbers that overlap with those used by other services are used, communication cannot be performed properly.

[Username]

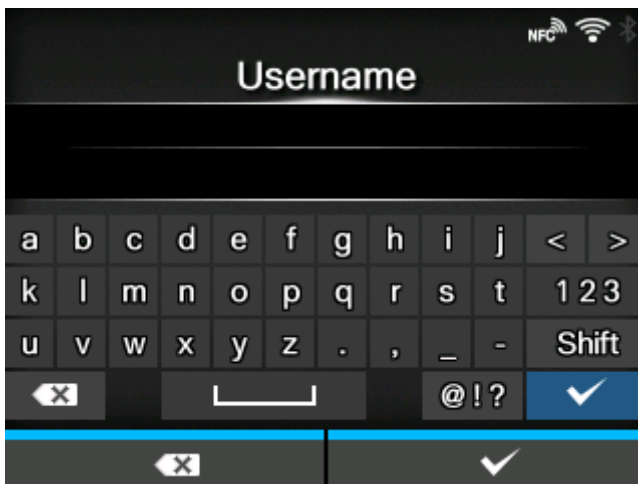

Set the username if you need a username to connect to the proxy server.

You can enter 1 to 8 characters. Alphabets (capital and small letters) and numbers can be used.

[Password]

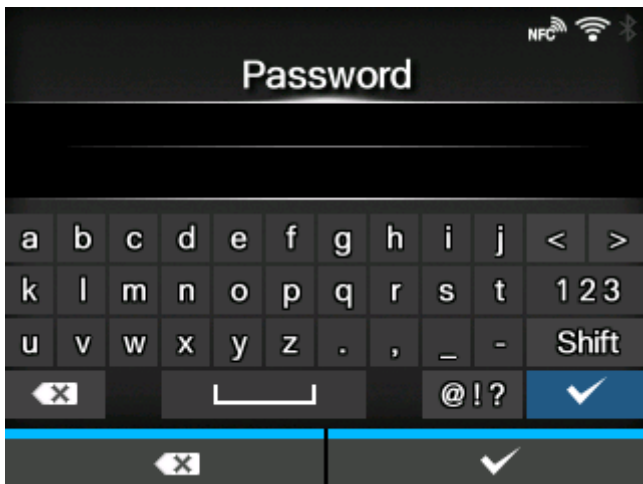

Set the password if you need a password to connect to the proxy server.

You can enter 1 to 16 characters. Alphabets (capital and small letters), numbers and symbols can be used.



- Some symbols cannot be used. If you enter a symbol that cannot be used, [Invalid value] appears on the screen.

[Exclude]

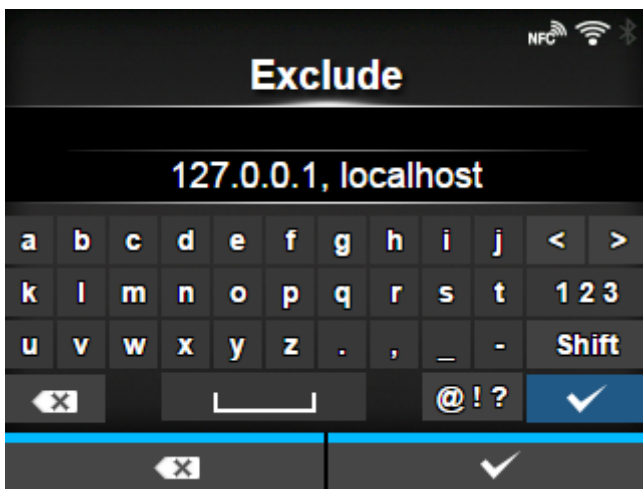

Set names, IP addresses or domains for the proxy to exclude.



- Exclude must contain at least 127.0.0.1 and localhost.

[DHCP Options]

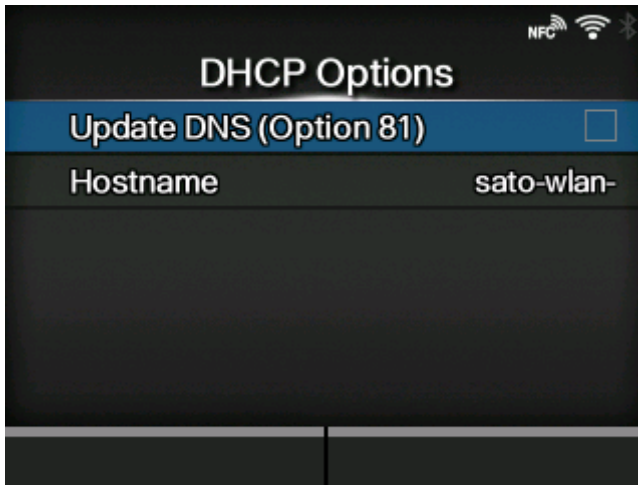

Configure the DHCP options for Wi-Fi.

[DHCP Options] can be set only if you have selected [DHCP] in the [IPv4] > [Mode] menu or [IPv6] > [Mode] menu.

The setting items are as follows:

[Update DNS \(Option 81\)](#)

Enable or disable the use of DHCP server option 81.

[Hostname](#)

Set the hostname.

[Update DNS (Option 81)]

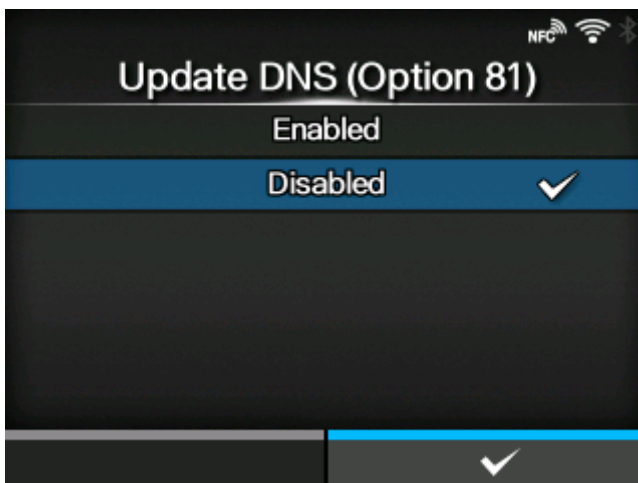

Enable or disable the use of DHCP server option 81.

The options are as follows:

[Enabled](#)

Enable the use of DHCP server option 81.

Disabled

Disable the use of DHCP server option 81.

[Hostname]

Set the hostname.

You can enter 0 to 255 characters. Alphabets (capital and small letters), numbers and symbols can be used.

[Wi-Fi Protected Setup]

Set the wireless LAN connection using the push button or PIN code method.

The setting items are as follows:

Button (PBC)

Set the wireless LAN connection using the push button method.

PIN

Set the wireless LAN connection using the PIN code method.



- Refer to the manual of the access point device for its operation.
- This screen does not appear if [LAN] or [Wi-Fi Direct] is active.

[Button (PBC)]

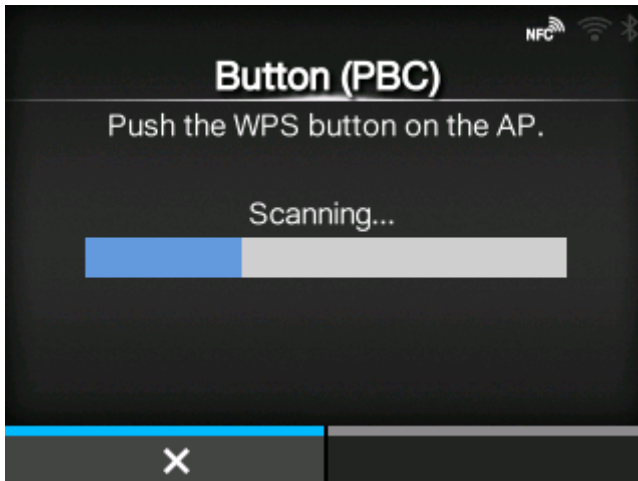

Set the wireless LAN connection using the push button method.

1. Select [Button (PBC)] in the [Wi-Fi Protected Setup] menu and press the  button.
2. When [Scanning...] appears on the screen, press the WPS button on the access point of the wireless LAN device.
3. When the connection to the access point is established, [Successfully configured.] appears on the screen.

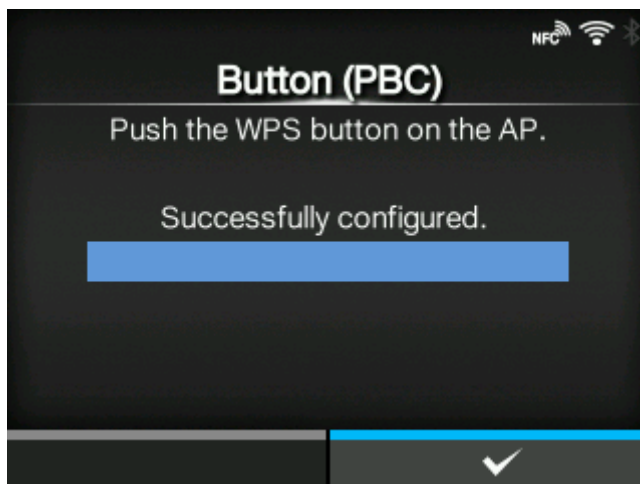

[PIN]

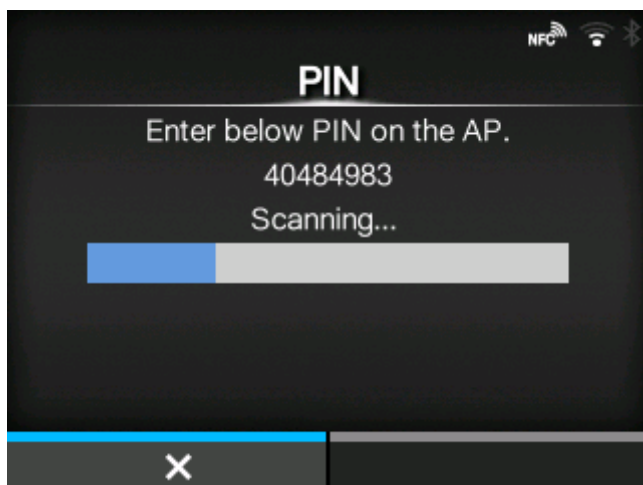

Set the wireless LAN connection using the PIN code method.

1. Select [PIN] in the [Wi-Fi Protected Setup] menu and press the  button.
2. When [Scanning...] appears on the screen, set the PIN code shown on the screen to the access point of the wireless LAN or computer.
3. When the connection to the access point is established, [Successfully configured.] appears on the screen.

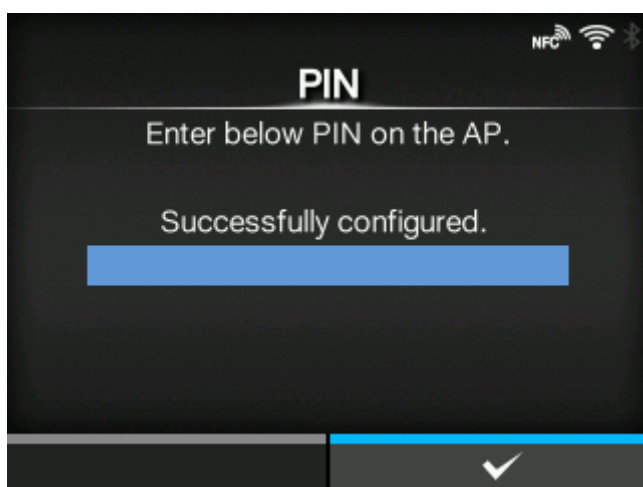

[Wi-Fi Direct]

Connect without group





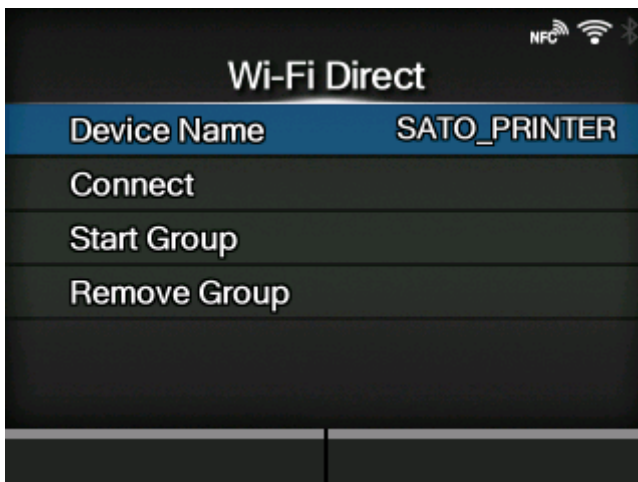

Connect with group



Set the Wi-Fi Direct function.

The Wi-Fi Direct function is enabled if you have selected [Infrastructure] in the [Mode] menu. If you have changed the setting from [Ad-hoc] to [Infrastructure] in the [Mode] menu, reboot the product before setting the Wi-Fi Direct function.

The setting procedure is as follows:

1. Set the device name for the product using [Device Name]. You can enter 1 to 32 characters. Alphabets (capital and small letters), numbers and symbols can be used. Press the  button to return to the [Wi-Fi] menu and press the  button to enable changes.
2. Select [Connect] to search and show the connectable device names or to accept connection requests when the product is the GO (Group Owner). Select the device name you want to connect using the  /  buttons, and press the  button.

3. Select [Start Group] if you want to start a new persistent group or select a group from the list.

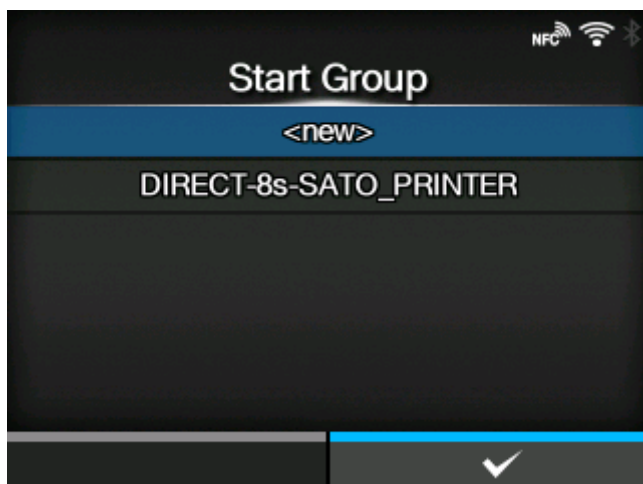

4. Select [Remove Group] to remove the persistent group in step 3.

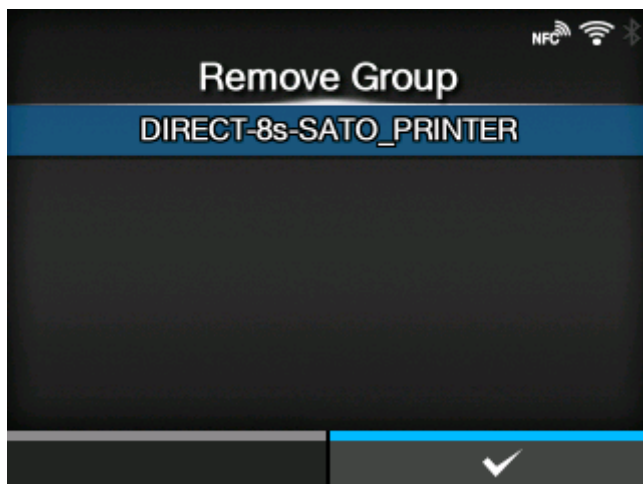

5. Complete the connection according to the display on the product or device you want to connect.
6. Select [Disconnect] if you want to stop the connection.



- You can connect a maximum of 10 devices.
 - When Wi-Fi Direct is active, [Device Name] cannot be changed.
 - [Start Group] and [Remove Group] are shown only if Wi-Fi is active and the product is not connected to a Wi-Fi Direct network.
 - [Remove Group] is shown if Wi-Fi is active and the product is connected.
 - After setting up a start group, the product will be set to the GO (Group Owner) and will wait for a connection request from another device.
 - If the product is powered off during a persistent group connection, the group will be started automatically after the product is powered on.
-

[Band]



Set the Band.

Enabled only if you have selected [Infrastructure] in the [Mode] menu.

The options are as follows:

- [All]
- [2.4 GHz]
- [5 GHz]

[SSID]



Set the SSID.

The screen shows the Wi-Fi network detected by the product.

Select the name of the Wi-Fi network you want to connect using the ▲ / ▼ buttons and press the  button to confirm.

To register a Wi-Fi network manually, press the  button and enter the name of the network.

You can enter a maximum of 32 characters. Alphabets (capital and small letters), numbers and symbols can be used.

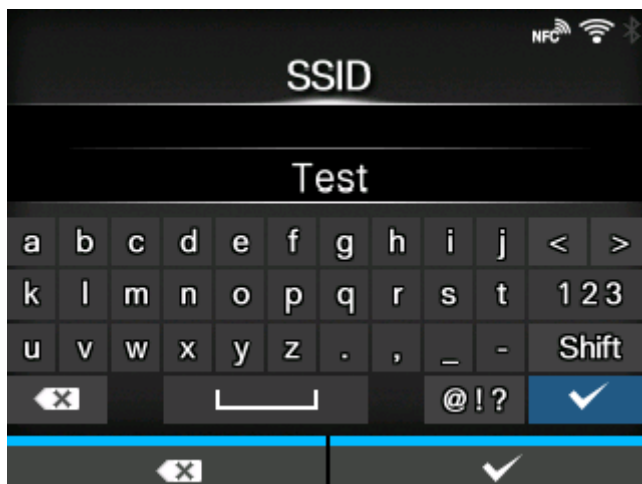

[Hidden SSID]

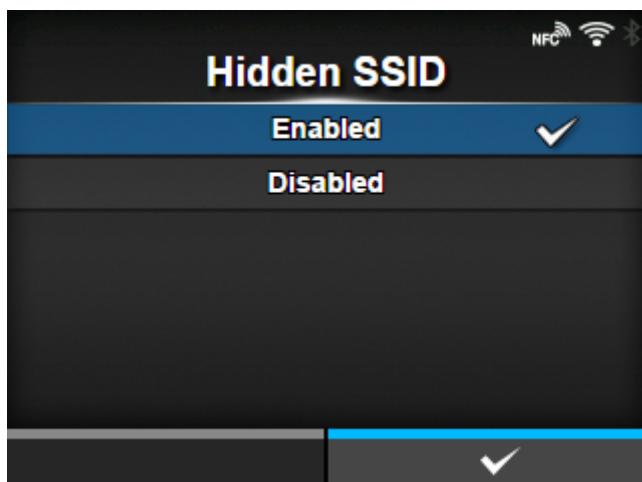

Set the hidden SSID (stealth function).

Appears if you have selected [Infrastructure] in the [Mode] menu.

The options are as follows:

Enabled

Enable the hidden SSID.

Disabled

Disable the hidden SSID.

[Mode]

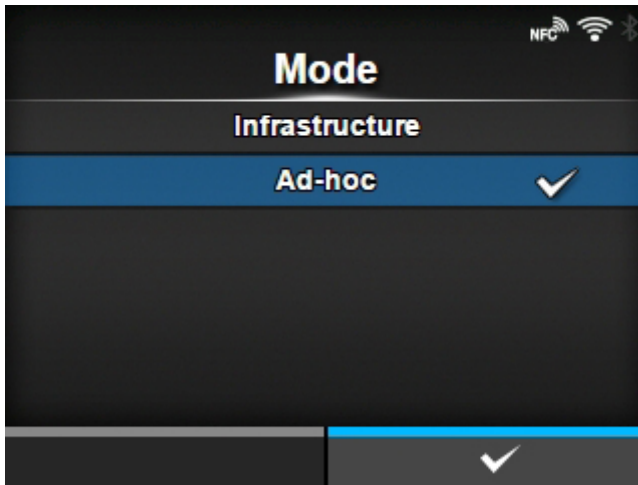

Set the communication method of the wireless LAN.

The options are as follows:

- [Infrastructure]
- [Ad-hoc]

[Channel]

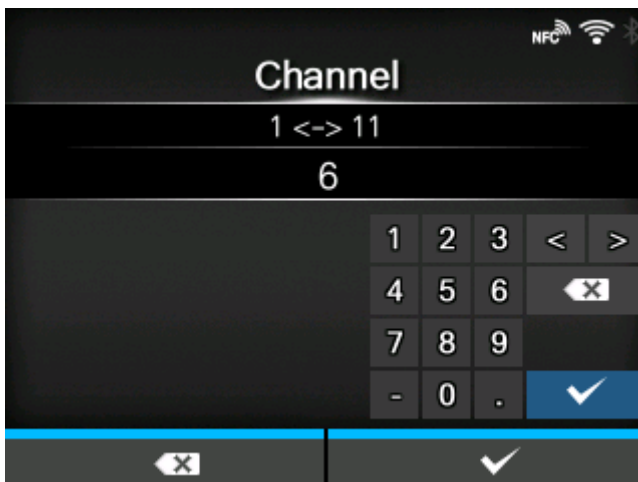

Set the communication channel.

[Channel] can be set only if you have selected [Ad-hoc] in the [Mode] menu.

The number of channels you can set varies depending on the region of the product.

[Security]

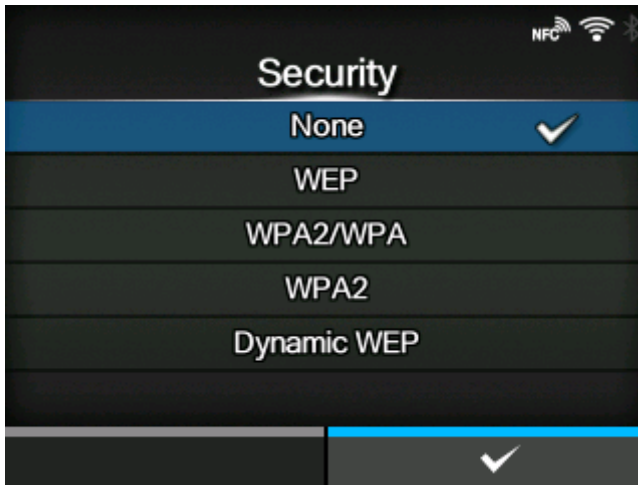

Set the security method of the network. Set the security methods so that the product, host and network devices match.

The options are as follows:

- [None]
- [WEP]
- [WPA2/WPA]
- [WPA2]
- [Dynamic WEP]

If you have selected [Ad-hoc] in the [Mode] menu, only [None] and [WEP] will be available.

[WEP Conf.]

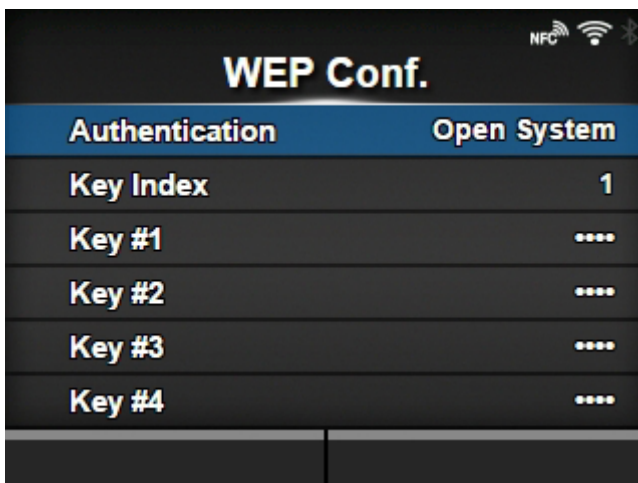

Set the WEP key.

Appears if you have selected [WEP] in the [Security] menu.

The setting items are as follows:

[Authentication](#)

Set the WEP authentication method.

[Key Index](#)

Set the key index.

[Key #1 to Key #4](#)

Set the WEP key1 - key4.

[Authentication]

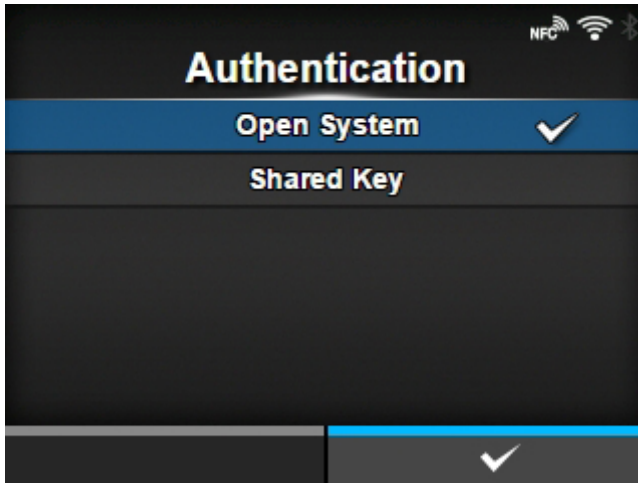

Set the WEP authentication method.

The options are as follows:

- [Open System]
- [Shared Key]

[Key Index]

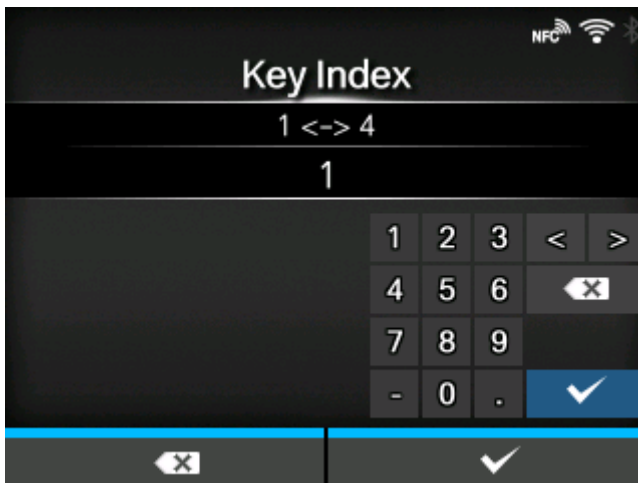

Set the key index.

Set the key index (WEP key) according to the access point of the wireless LAN you connect.

The setting range is from 1 to 4.



- Depending on the connecting device, the range of the key index may be 0 to 3. In such a case, if you have set the product to 1, set the connecting device to 0.

[Key #1] to [Key #4]

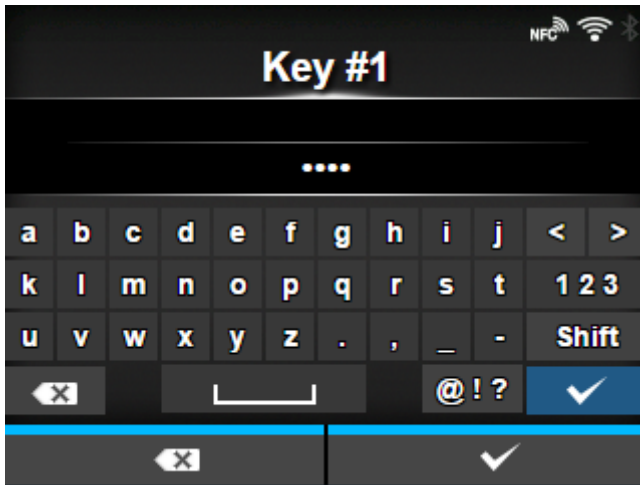

Set the WEP key #1 - key #4.

You can enter alphabets (capital and small letters) and numbers.

Depending on the length of the WEP key, the number of characters you can set is as follows:

- When the key length is 64 bits
 - ASCII: Five characters
 - Hexadecimal: 10 characters
- When the key length is 128 bits
 - ASCII: Thirteen characters
 - Hexadecimal: 26 characters

[WPA Conf.]

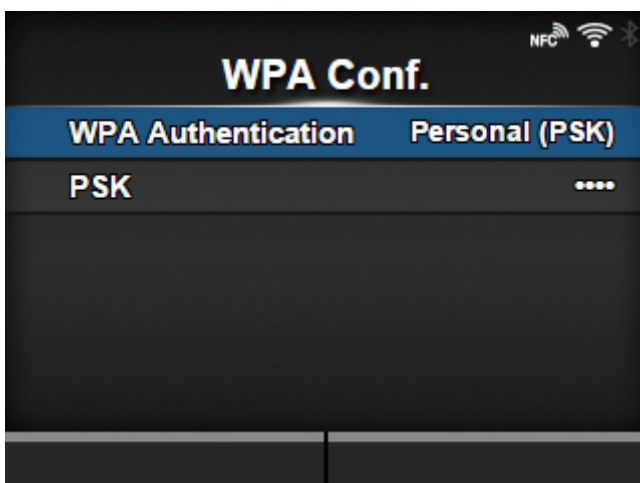

Set the WPA authentication.

Appears only if you have selected [WPA2/WPA] or [WPA2] in the [Security] menu.

The setting items are as follows:

[WPA Authentication](#)

Set the WPA authentication method.

[PSK](#)

Set the PSK shared key.

- Appears only if you have selected [Personal (PSK)] in the [WPA Authentication] menu.

[EAP Conf.](#)

Set the functions for EAP.

- Appears only if you have selected items other than [Personal (PSK)] in the [WPA Authentication] menu.

[\[WPA Authentication\]](#)

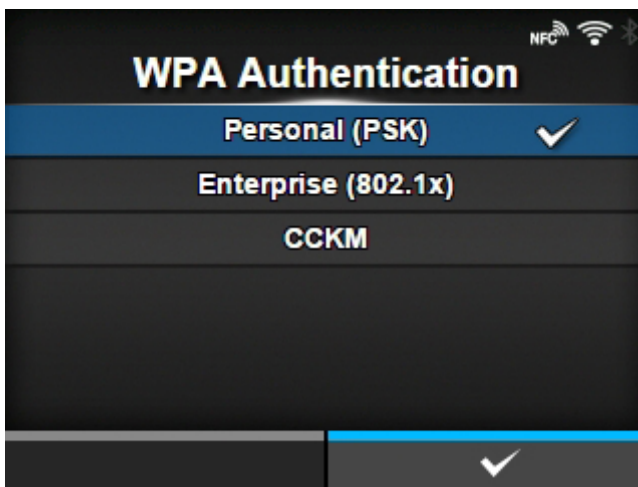

Set the WPA authentication method.

The options are as follows:

- [Personal (PSK)]
- [Enterprise (802.1x)]
- [CCKM]

[\[PSK\]](#)

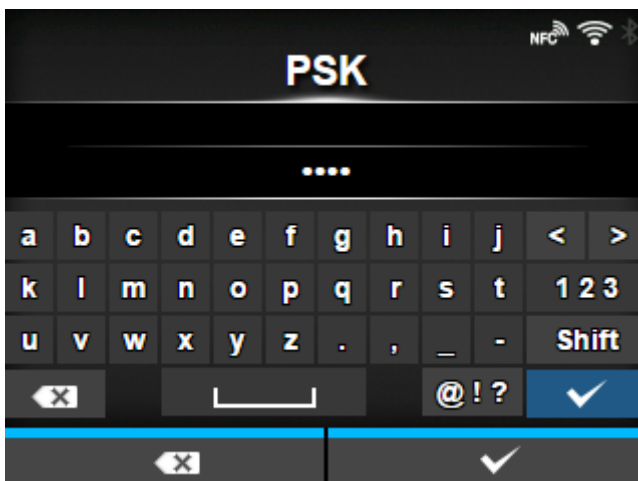

Set the PSK shared key.

Appears only if you have selected [Personal (PSK)] in the [WPA Authentication] menu.

You can enter 8 to 63 ASCII characters or 64 hexadecimal digits. Alphabets, numbers and symbols can be used.

[EAP Conf.]

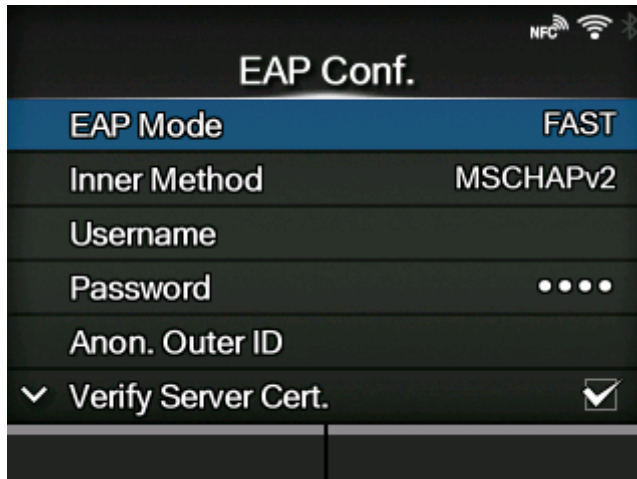

Set the functions for EAP.

Appears only if you have selected items other than [Personal (PSK)] in the [WPA Authentication] menu or if you have selected [Dynamic WEP] in the [Security] menu.

The setting items are as follows:

[EAP Mode](#)

Set the EAP Mode (authentication mode).

[Inner Method](#)

Set the inner method.

- Appears only if you have selected [FAST], [PEAP], or [TTLS] in the [EAP Mode] menu.

[Username](#)

Set the user name.

[Password](#)

Set the password.

[Anon. Outer ID](#)

Set the external ID.

- Appears only if you have selected [FAST], [PEAP], or [TTLS] in the [EAP Mode] menu.

[Verify Server Cert.](#)

Enable or disable server authentication.

- Appears if you have selected anything other than [LEAP] in the [EAP Mode] menu.

[Private Key P/W](#)

Set the Private Key password.

- Appears only if you have selected [TLS] in either the [EAP Mode] menu or [Inner Method] menu.

[PAC Auto Provisioning](#)

Enable or disable PAC Auto Provisioning.

- Appears only if you have selected [FAST] in the [EAP Mode] menu.

[PAC P/W](#)

Set the PAC password.

- Appears only if you have selected [FAST] in the [EAP Mode] menu and if you have selected [Disabled] in [PAC Auto Provisioning].

[\[EAP Mode\]](#)

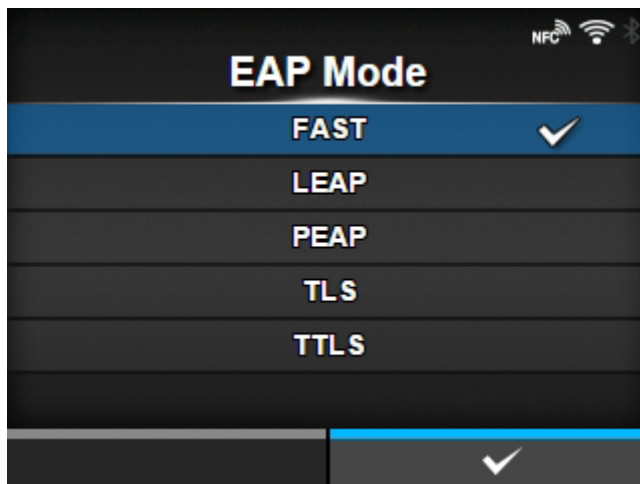

Set the EAP Mode (authentication mode).

The options are as follows:

- [FAST]
- [LEAP]
- [PEAP]
- [TLS]
- [TTLS]

[\[Inner Method\]](#)

Set the inner method.

Appears only if you have selected [FAST], [PEAP], or [TTLS] in the [EAP Mode] menu.

When Wireless LAN module is W-LAN2¹

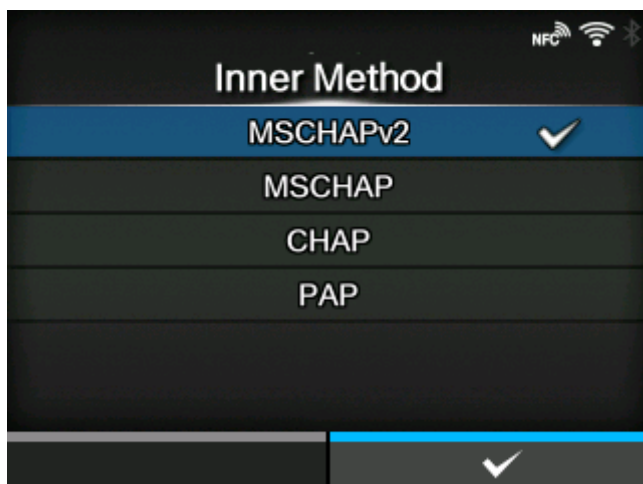

- If you have selected [FAST] in the [EAP Mode] menu, the option is [AUTO].
- If you have selected [PEAP] in the [EAP Mode] menu, the option is [MSCHAPv2].
- If you have selected [TTLS] in the [EAP Mode] menu, the options are [MSCHAPv2], [MSCHAP], [CHAP], and [PAP].

When Wireless LAN module is W-LAN¹

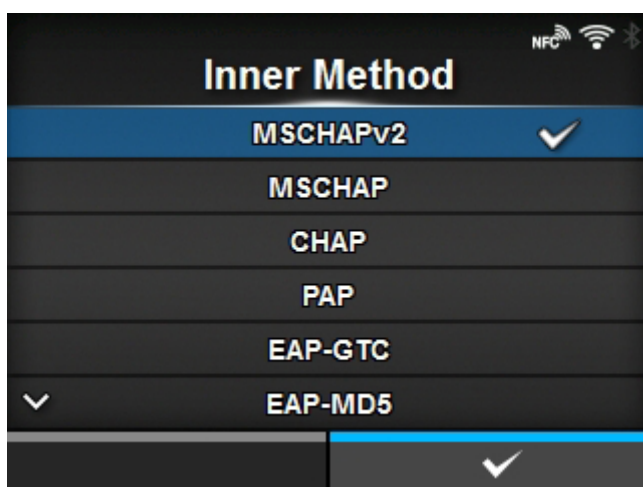

- If you have selected [FAST] in the [EAP Mode] menu, the options are [MSCHAPv2], [GTC], and [TLS].
- If you have selected [PEAP] in the [EAP Mode] menu, the options are [MSCHAPv2], [GTC], [MD5], [OTP], and [TLS].
- If you have selected [TTLS] in the [EAP Mode] menu, the options are [MSCHAPv2], [MSCHAP], [CHAP], [PAP], [EAP-GTC], [EAP-MD5], [EAP-MSCHAPV2], [EAP-OTP], and [EAP-TLS].

¹ The installed wireless LAN module is displayed in [Wi-Fi Module] in the [Information] menu.

[Username]

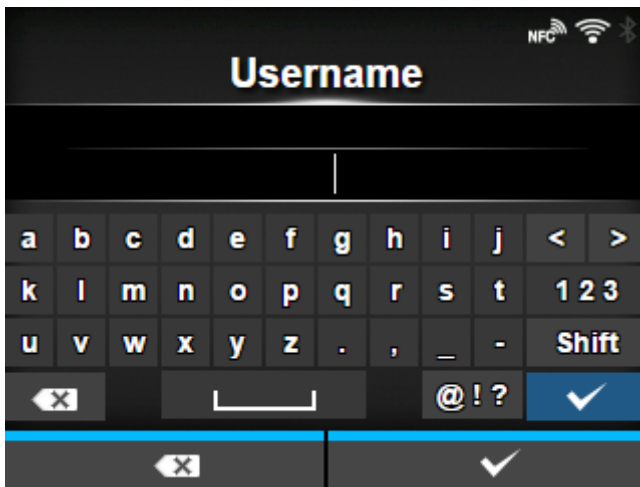

Set the user name.

You can enter 0 to 63 characters. Alphabets, numbers and symbols can be used.

[Password]

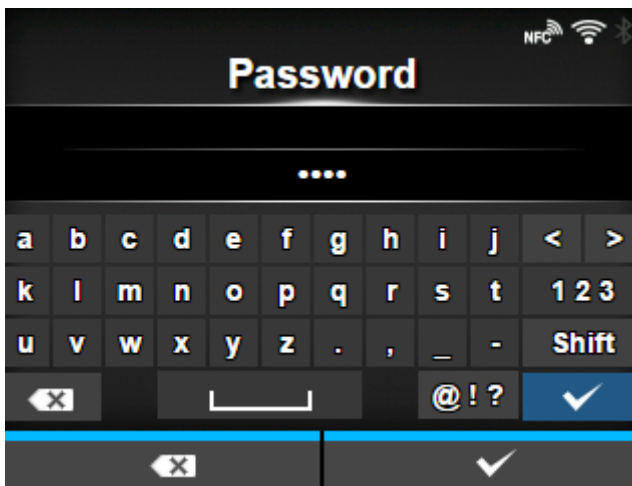

Set the password.

You can enter 0 to 32 characters. Alphabets, numbers and symbols can be used.

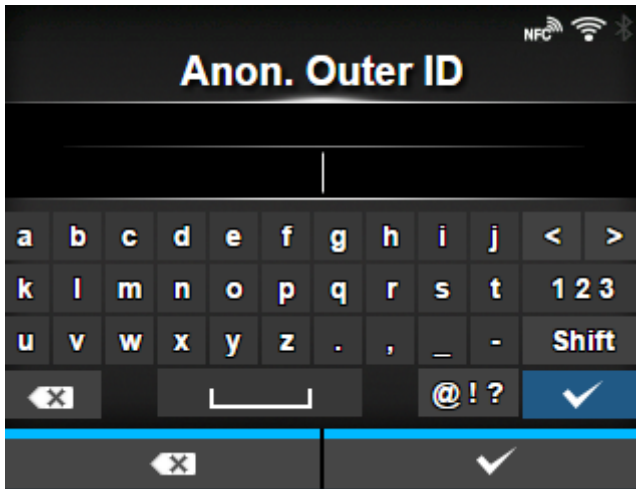
[Anon. Outer ID]

Set the external ID.

Appears if you have selected [FAST], [PEAP], or [TTLS] in the [EAP Mode] menu.

You can enter 0 to 63 characters. Alphabets, numbers and symbols can be used.

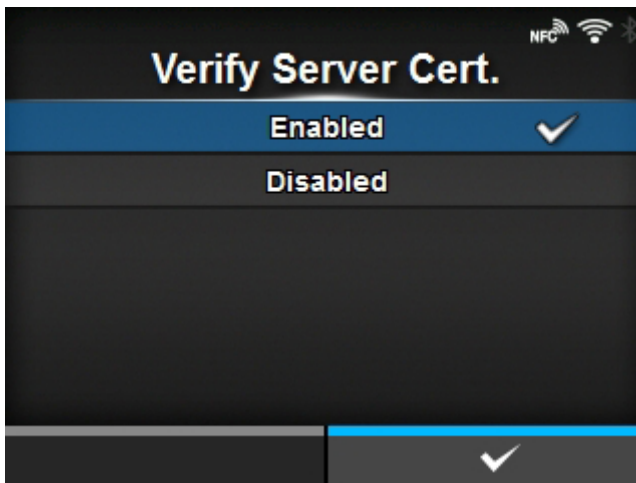
[Verify Server Cert.]

Enable or disable server certificate validation.

Appears if you have selected anything other than [LEAP] in the [EAP Mode] menu.

The options are as follows:

Enabled

Enable server certificate validation.

Disabled

Disable server certificate validation.

[Private Key P/W]



Set the Private Key password.

When the wireless LAN module is W-LAN2, this menu appears only if you have selected [TLS] in the [EAP Mode] menu.

When the wireless LAN module is W-LAN, this menu appears only if you have selected [TLS] in either the [EAP Mode] menu or [Inner Method] menu.

The installed wireless LAN module is displayed in [Wi-Fi Module] in the [Information] menu.

You can enter 0 to 64 characters. Alphabets, numbers and symbols can be used.

[PAC Auto Provisioning]

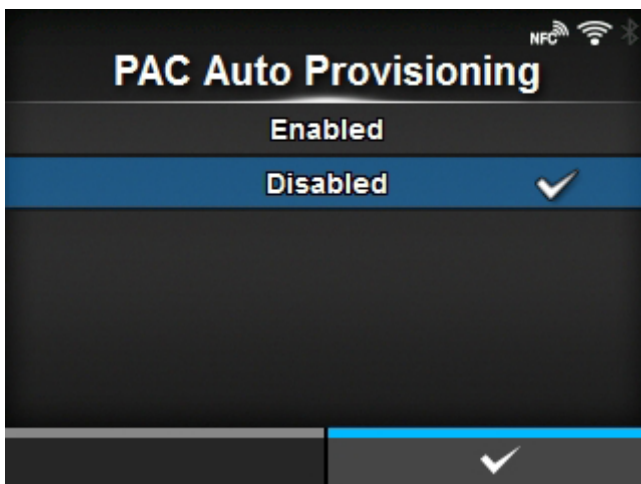

Enable or disable PAC auto provisioning.

Appears if you have selected [FAST] in the [EAP Mode] menu.

The options are as follows:

Enabled

Enable PAC auto provisioning.

Disabled

Disable PAC auto provisioning.

[PAC P/W]

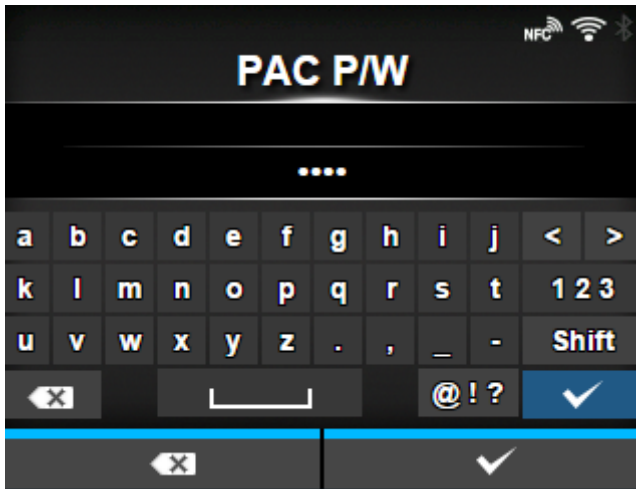

Set the PAC password.

Appears only if you have selected [FAST] in the [EAP Mode] menu and if you have selected [Disabled] in [PAC Auto Provisioning].

You can enter 0 to 64 characters. Alphabets, numbers and symbols can be used.

[Interface]

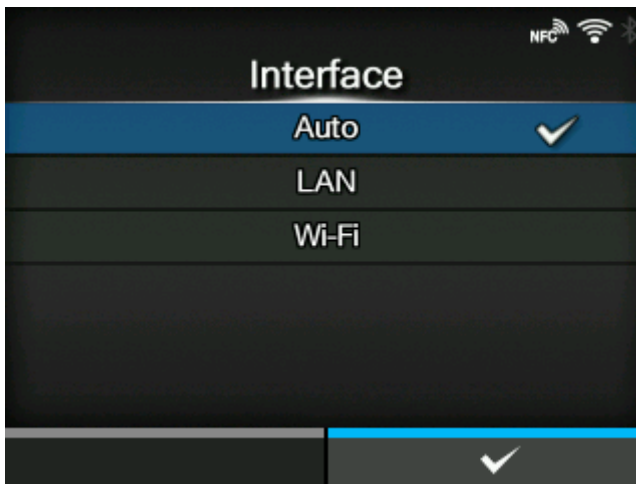

Select the network interface.

This item is to select the network interface from LAN or wireless LAN when you have installed the optional wireless LAN.

The options are as follows:

Auto

Automatically select between LAN and wireless LAN interface at product startup. LAN is selected if LAN cable is connected to a link-established hub (Link LED is flashing) at product startup. Wireless LAN is selected if LAN is not detected at product startup.

LAN

Use LAN interface (or force LAN interface).

Wi-Fi

Use wireless LAN interface (or force wireless LAN interface).

- Appears only if you have installed the optional wireless LAN.



- A message prompting you to restart the product will appear on the Online/Offline screen if you have made any changes. In such a case, reboot the product to apply the settings.
-

[Services]

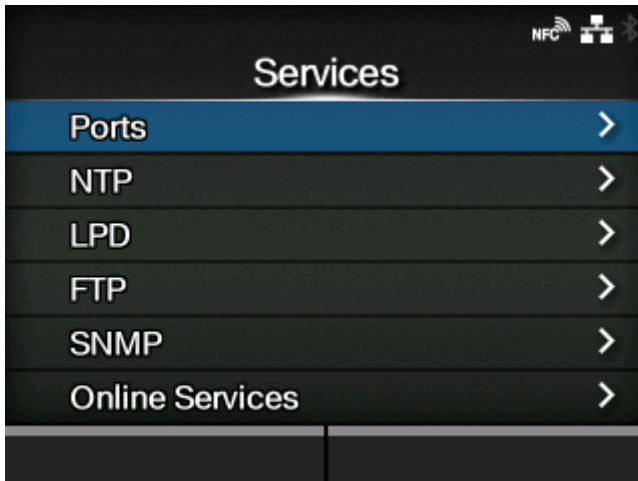

Set the TCP/IP port number, NTP, LPD, FTP, SNMP, or SOS (SATO Online Services).

The setting items are as follows:

[Ports](#)

Set the TCP/IP port number.

[NTP](#)

Set the functions for NTP.

[LPD](#)

Set the functions for LPD.

[FTP](#)

Set the functions for FTP.

[SNMP](#)

Set the functions for SNMP.

[Online Services](#)

Set the functions for SOS (SATO Online Services).

[Ports]

Ports	
Port1	1024
Port2	1025
Port3	9100
Flow Control	Status4 ENQ
TCP Connection Queue	<input checked="" type="checkbox"/>
Legacy Status for Port 9100	<input type="checkbox"/>

Set the TCP/IP port number.

The setting items are as follows:

[Port1](#)

Set the port number of Port1.

For the two-port connection of Status4, this port is used for receiving print data. For the one-port connection of Status3/Status5, this port is used for both receiving print data and returning the product status.

[Port2](#)

Set the port number of Port2.

For the two-port connection of Status4, this port is used for returning the product status.

[Port3](#)

Set the port number of Port3.

For the one-port connection of Status3/Status4/Status5, this port is used for both receiving print data and returning the product status.

[Flow Control](#)

Set the communication protocol.

[TCP Connection Queue](#)

Set whether to allow queuing for connection when multiple hosts or applications are sending connection requests to the product.

[Legacy Status for Port 9100](#)

Set whether to change the return status format of Port3 to legacy status.

- Does not appear if you have selected [None] in the [Flow Control] menu.

[ENQ Reply Delay](#)

Set the period to delay status reply to status request ENQ.

- Not available if you have selected [Status4] in the [Flow Control] menu.

Status4 Cyclic Response

Set the interval for the cyclic status response.

- Available only if you have selected [Status4] in the [Flow Control] menu.

BCC

Set the BCC check function.

- Appears only if you have selected [Status5] in the [Flow Control] menu.

Roles of Port1 to Port3

In the socket server function of TCP/IP, either of the following connection methods can be used.

The ports to be used and their roles change depending on the connection method and communication protocol.

Two-port connection

Port1 is used for receiving print data, and Port2 is used for returning the product status.

Two-port connection is available when the communication protocol is Status4.

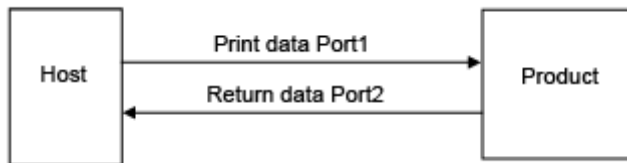

One-port connection

One port is used for both receiving print data and returning the product status.

When the communication protocol is Status4, Port3 is used.

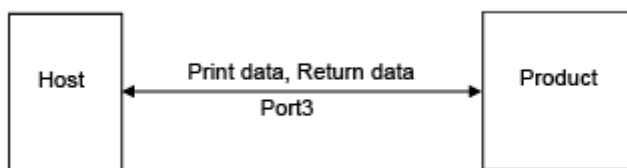

When the communication protocol is Status3 or Status5, Port1 or Port3 is used.

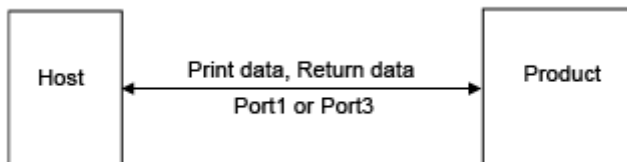

[Port1]

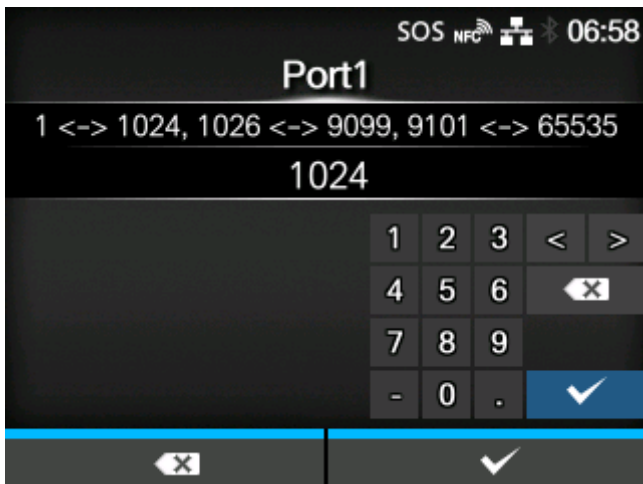

Set the port number of Port1.

For the two-port connection of Status4, this port is used for receiving print data. For the one-port connection of Status3/Status5, this port is used for both receiving print data and returning the product status.

The setting range is from 1 to 65535.



- Each port (1, 2 and 3) must be set to different values.
- Set a port number not used by other services. If port numbers that overlap with those used by other services are used, communication cannot be performed properly.

[Port2]

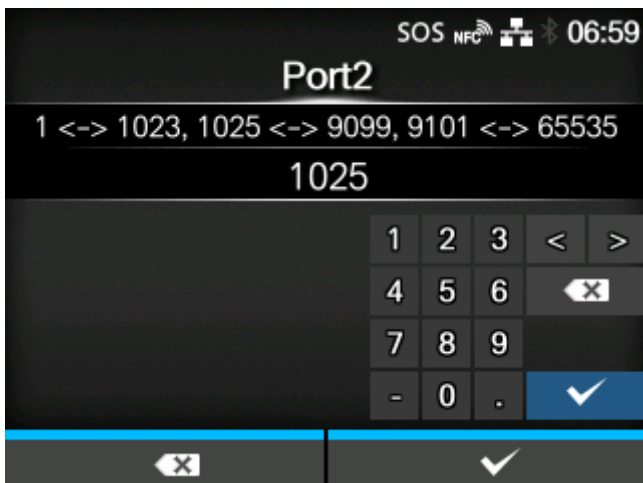

Set the port number of Port2.

For the two-port connection of Status4, this port is used for returning the product status.

The setting range is from 1 to 65535.



- Each port (1, 2 and 3) must be set to different values.
- Set a port number not used by other services. If port numbers that overlap with those used by other services are used, communication cannot be performed properly.



- This setting is disabled when AEP mode is enabled.

[Port3]



Set the port number of Port3.

For the one-port connection of Status3/Status4/Status5, this port is used for both receiving print data and returning the product status.

The setting range is from 1 to 65535.



- Each port (1, 2 and 3) must be set to different values.
- Set a port number not used by other services. If port numbers that overlap with those used by other services are used, communication cannot be performed properly.



- You can change the return status format of port3 to Compatible mode by enabling [Legacy Status for Port 9100].

[Flow Control]

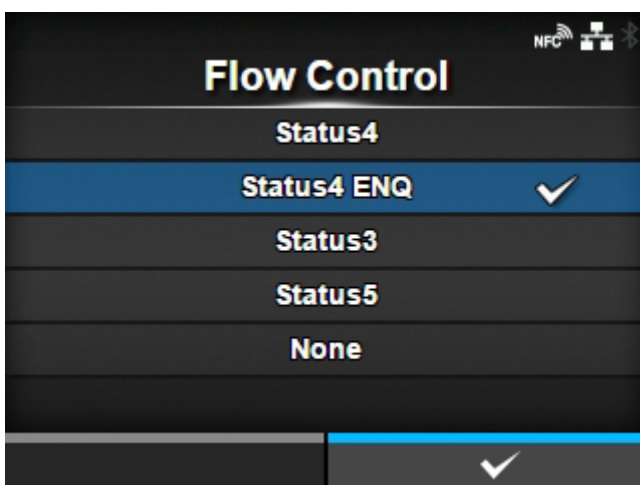

Set the communication protocol.

The options are as follows:

- [Status4]

- [Status4 ENQ]
- [Status3]
- [Status5]
- [None]

[TCP Connection Queue]

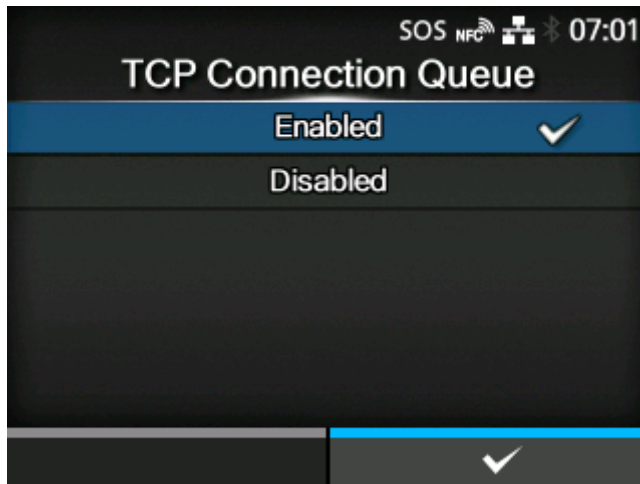

Set whether to allow queuing for connection when multiple hosts or applications are sending connection requests to the product.

The options are as follows:

Enabled

While connecting with one host or application, the product can receive connection requests from other hosts or applications. The subsequent connection requests are put on hold, and processed in order of reception after the first connection is closed.

Disabled

While connecting with one host or application, the product cannot receive connection requests from other hosts or applications.



- When you have selected [Enabled], be sure to use one port connection for Status3, Status4, and Status5. Operation using two port connections for Status4 is not guaranteed.
-

[Legacy Status for Port 9100]

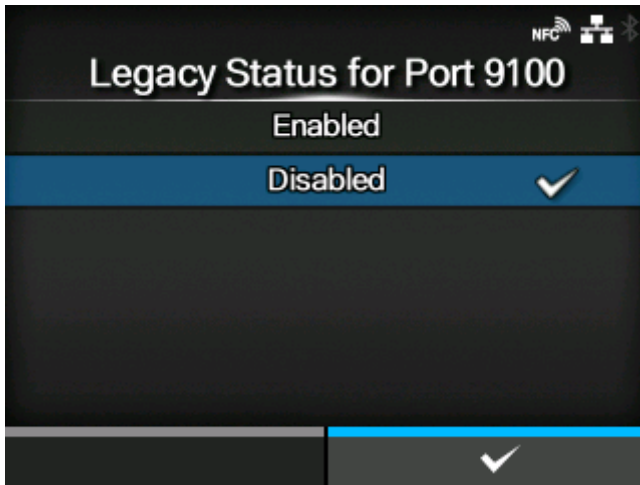

Set whether to change the return status format of port3 to legacy status.
Does not appear if you have selected [None] in the [Flow Control] menu.
The options are as follows:

Enabled

Change the return status format of port3 to legacy status.

Disabled

Do not change the return status format of port3 to legacy status.

In legacy status, the return status format of port3 becomes as follows:

Status3

Mode	Data format
Normal ([Legacy Status for Port 9100] is [Disabled])	<p>ACK/NAK Reply</p> <p>ACK/NAK 1 byte</p> <p>Status Reply</p> <p>STX Status3 ETX 11 bytes</p>
Legacy status ([Legacy Status for Port 9100] is [Enabled])	<p>ACK/NAK Reply</p> <p>ACK/NAK 1 byte</p> <p>Status Reply</p> <p>00 00 00 0b STX Status3 ETX 15 bytes</p>

Status4

Mode	Data format									
Normal ([Legacy Status for Port 9100] is [Disabled])	<p>ACK/NAK Reply</p> <table border="1"> <tr> <td>00 00 00 01</td> <td>ACK/NAK</td> <td>5 bytes</td> </tr> </table> <p>Status Reply</p> <table border="1"> <tr> <td>00 00 00 1C</td> <td>ENQ</td> <td>STX</td> <td>Status4</td> <td>ETX</td> <td>32 bytes</td> </tr> </table>	00 00 00 01	ACK/NAK	5 bytes	00 00 00 1C	ENQ	STX	Status4	ETX	32 bytes
00 00 00 01	ACK/NAK	5 bytes								
00 00 00 1C	ENQ	STX	Status4	ETX	32 bytes					
Legacy status ([Legacy Status for Port 9100] is [Enabled])	<p>ACK/NAK Reply</p> <table border="1"> <tr> <td>ACK/NAK</td> <td>1 byte</td> </tr> </table> <p>Status Reply</p> <table border="1"> <tr> <td>00 00 00 20</td> <td>00 00 00 1C</td> <td>ENQ</td> <td>STX</td> <td>Status4</td> <td>ETX</td> <td>36 bytes</td> </tr> </table>	ACK/NAK	1 byte	00 00 00 20	00 00 00 1C	ENQ	STX	Status4	ETX	36 bytes
ACK/NAK	1 byte									
00 00 00 20	00 00 00 1C	ENQ	STX	Status4	ETX	36 bytes				

Status5

Mode	Data format					
Normal ([Legacy Status for Port 9100] is [Disabled])	<p>ACK/NAK Reply</p> <p>No Reply</p> <p>Status Reply</p> <table border="1"> <tr> <td>STX</td> <td>Status5</td> <td>ETX</td> <td>22 bytes</td> </tr> </table>	STX	Status5	ETX	22 bytes	
STX	Status5	ETX	22 bytes			
Legacy status ([Legacy Status for Port 9100] is [Enabled])	<p>ACK/NAK Reply</p> <p>No Reply</p> <p>Status Reply</p> <table border="1"> <tr> <td>00 00 00 16</td> <td>STX</td> <td>Status5</td> <td>ETX</td> <td>26 bytes</td> </tr> </table>	00 00 00 16	STX	Status5	ETX	26 bytes
00 00 00 16	STX	Status5	ETX	26 bytes		

[ENQ Reply Delay]

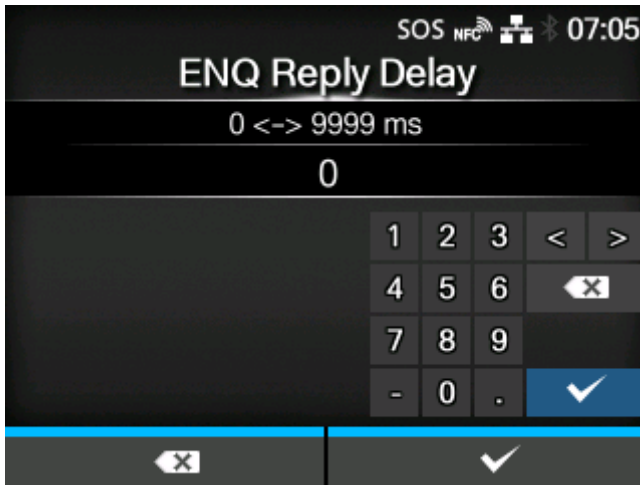

Set the period to delay status reply to status request ENQ.

The target interfaces are LAN and Wireless LAN.

The target statuses are Status3, Status4 ENQ reply, and Status5.

The setting range is from 0 to 9999 ms.



- Normally, keep this setting at the default value.
-

[Status4 Cyclic Response]

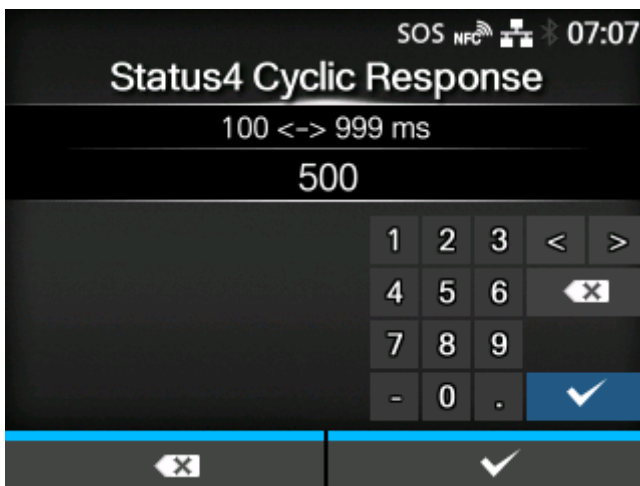

Set the interval for the cyclic status response.

The target interfaces are LAN and Wireless LAN.

The target status is Status4 reply cycle.

The setting range is from 100 to 999 ms.

[BCC]

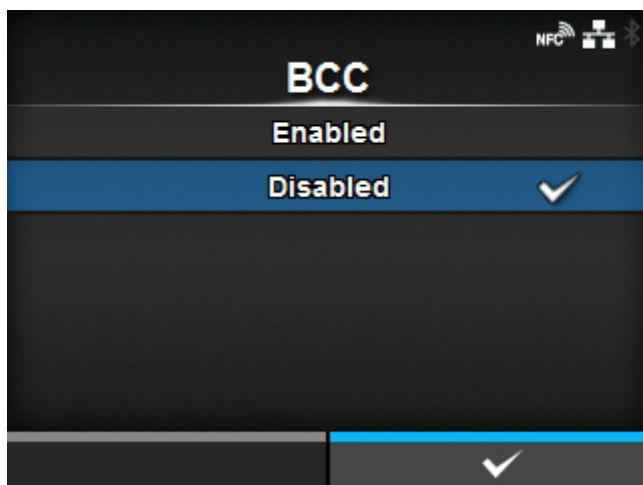

Enable or disable the BCC check function.

Appears only if you have selected [Status5] in the [Flow Control] menu.

The options are as follows:

Enabled

Enable the BCC check function.

Disabled

Disable the BCC check function.

[NTP]

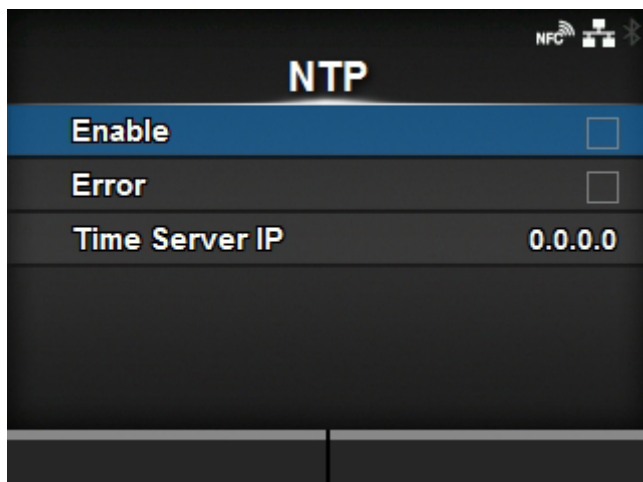

Set the functions for NTP.

The NTP function gets the time information from the NTP server through the network and sets the time of the product.

The setting items are as follows:

Enable

Enable or disable the functions for NTP.

Error

Set to show the NTP error message if detected.

Time Server IP

Set the IP address of the NTP server.

[Enable]

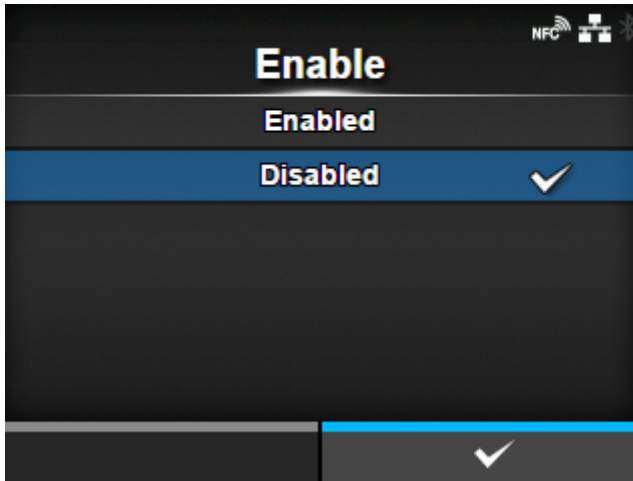

Enable or disable the functions for NTP.

The options are as follows:

Enabled

Enable the NTP function.

Disabled

Disable the NTP function.

[Error]

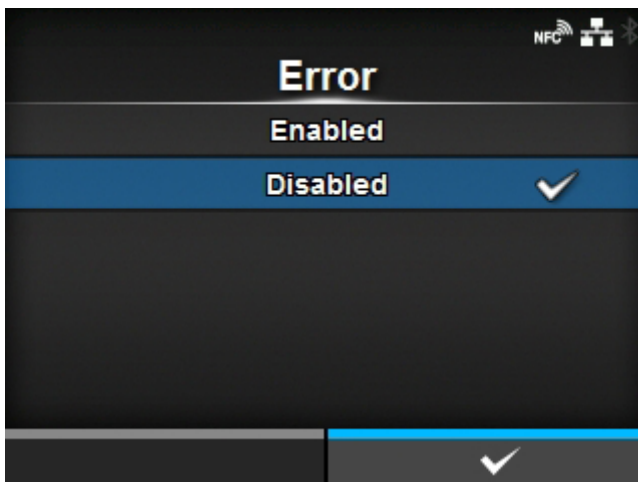

Set to show the NTP error message if detected.

The options are as follows:

Enabled

Shows the error message.

Disabled

Does not show the error message.

[Time Server IP]



Set the IP address of the NTP server.

The setting range is as follows:

0.0.0.0 to 255.255.255.255

The IP address should normally be set to 0.0.0.0 (the default value). For the default value, the global NTP servers are assigned automatically. Set to a valid IP if the time synchronization is requested for a specific server.

[LPD]

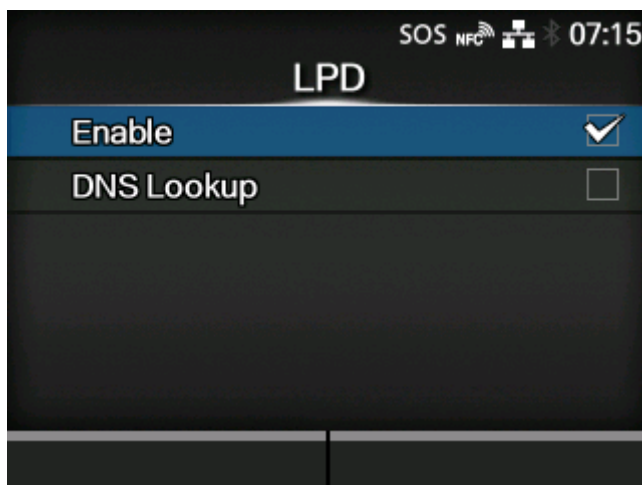

Set the functions for LPD.

The setting items are as follows:

[Enable](#)

Enable or disable the LPD function.

[DNS Lookup](#)

Enable or disable the DNS Lookup function.

[Enable]

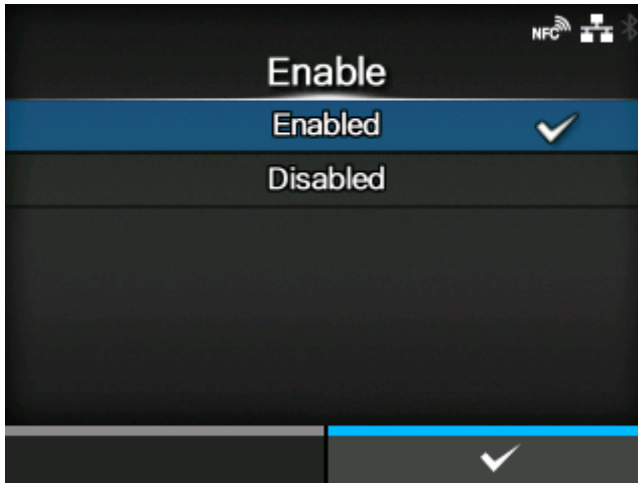

Enable or disable the LPD function.

The options are as follows:

Enabled

Enable the LPD function.

Disabled

Disable the LPD function.

[DNS Lookup]

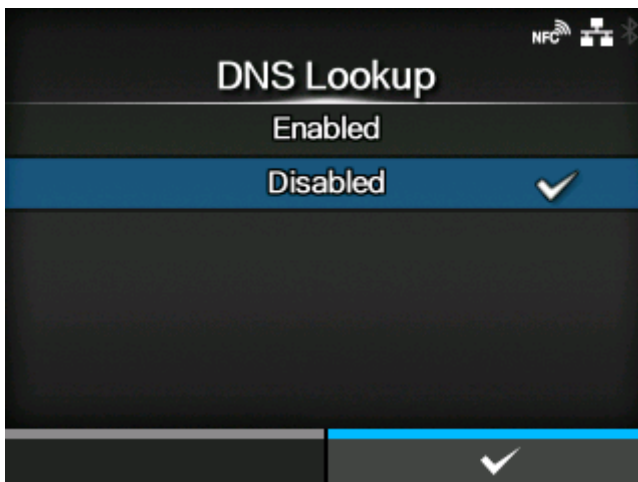

Enable or disable the DNS Lookup function.

The options are as follows:

Enabled

Enable the DNS Lookup function.

Disabled

Disable the DNS Lookup function.

[FTP]

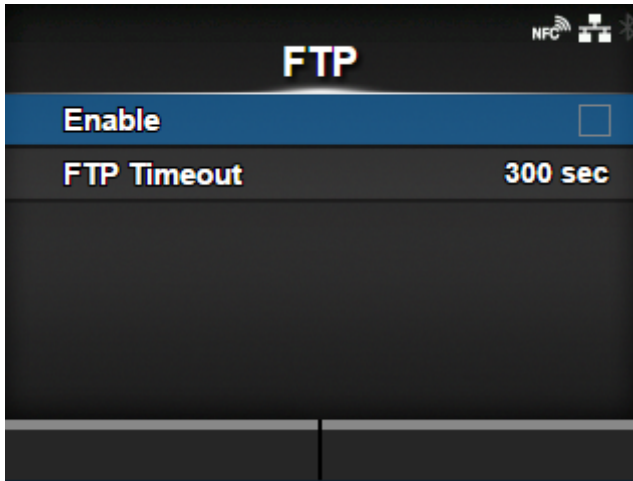

Set the functions for FTP.

The setting items are as follows:

[Enable](#)

Enable or disable the functions for FTP.

[FTP Timeout](#)

Set the connection timeout period between the product's FTP server and clients.

[Enable]

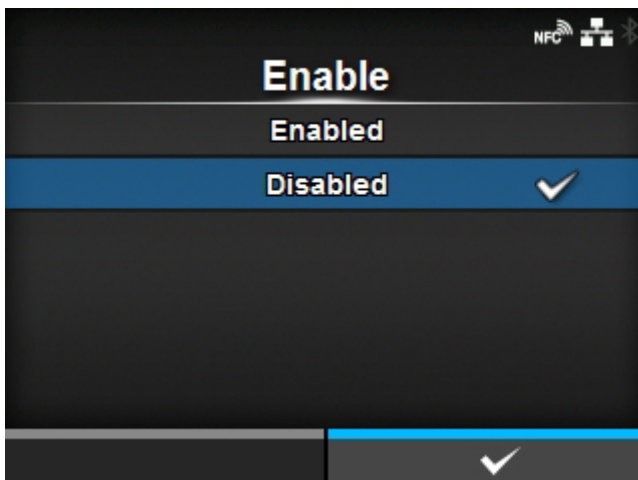

Enable or disable the functions for FTP.

The options are as follows:

Enabled

Enable the FTP function.

Disabled

Disable the FTP function.

[FTP Timeout]

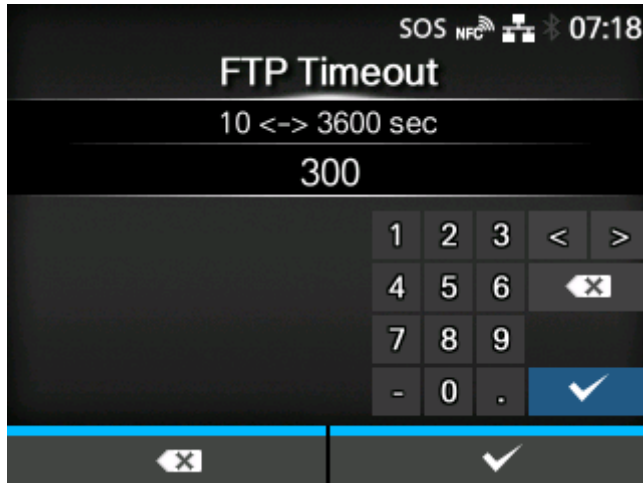

Set the connection timeout period between the product's FTP server and clients.

Specify the maximum number of seconds that the product's FTP server will allow clients to stay connected without receiving any data on either the control or data connection.

The setting range is from 10 to 3600 seconds.

[SNMP]

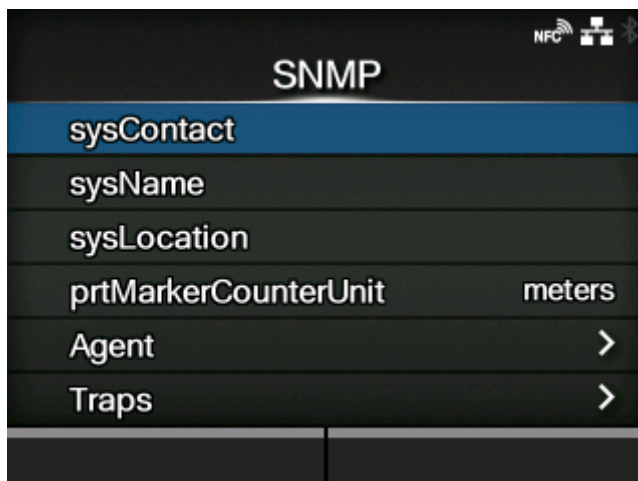

Set the functions for SNMP.

The SNMP function enables you to monitor and manage a UDP/IP based network.

The setting items are as follows:

[sysContact](#)

Set the contact information.

[sysName](#)

Set the name information.

[sysLocation](#)

Set the location information.

[prtMarkerCounterUnit](#)

Set the unit to use for reporting counter values for subunits.

[Agent](#)

Set the Agent function.

[Traps](#)

Set the Traps function.

[sysContact]

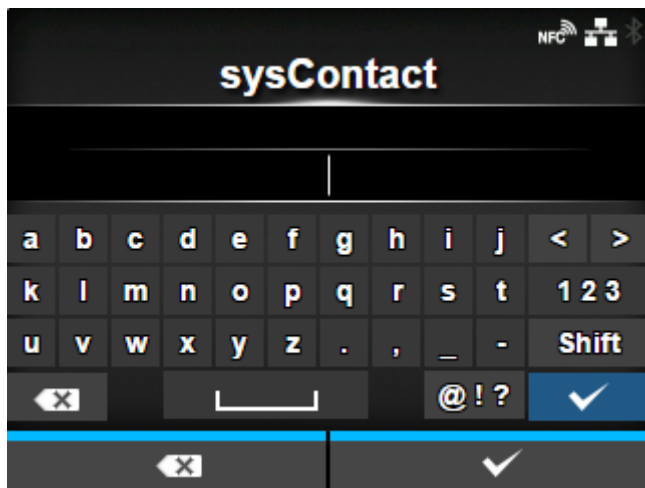

Set the contact information.

You can enter 0 to 255 characters. Alphabets, numbers and symbols can be used.

[sysName]

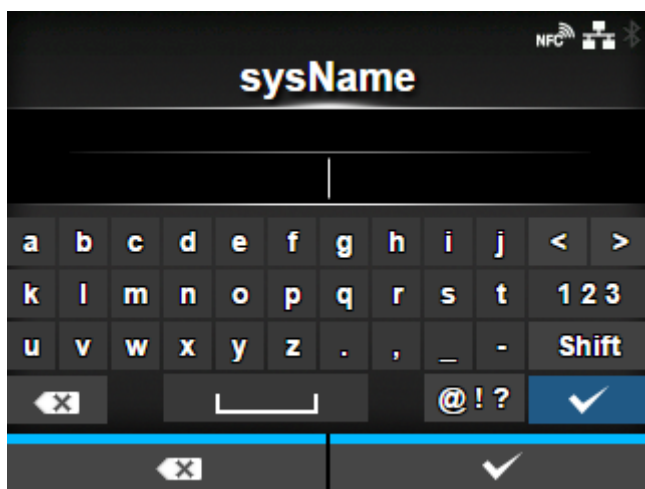

Set the name information.

You can enter 0 to 255 characters. Alphabets, numbers and symbols can be used.

[sysLocation]

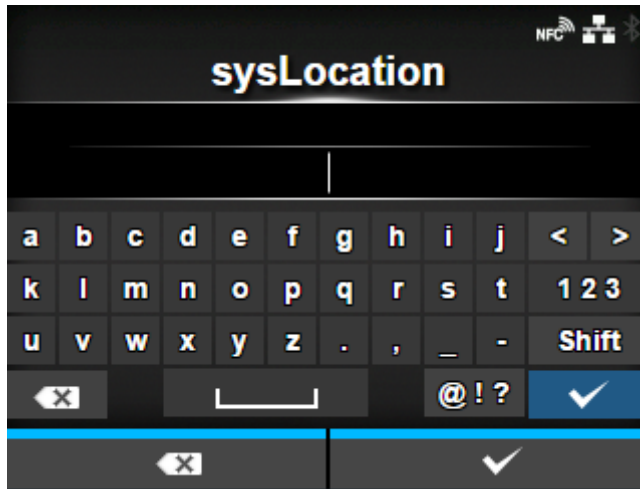

Set the location information.

You can enter 0 to 255 characters. Alphabets, numbers and symbols can be used.

[prtMarkerCounterUnit]



Set the unit to use for reporting counter values for subunits.

The options are as follows:

impressions

Report the number of printed labels.

meters

Report the length of printed labels in meters.

[Agent]

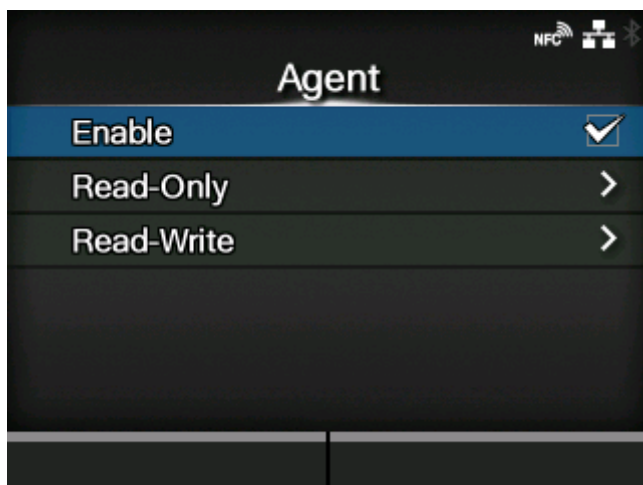

Set the Agent function.

The setting items are as follows:

[Enable](#)

Use the Agent function.

[Read-Only](#)

Set the read-only function.

[Read-Write](#)

Set the read-write function.

[Enable]

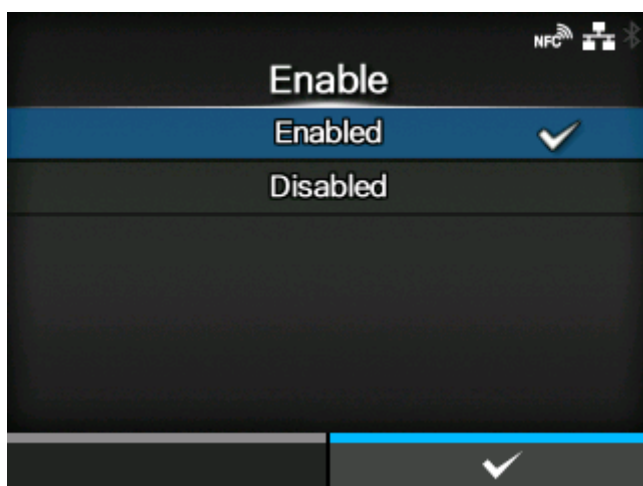

Enable or disable the functions for Agent.

The options are as follows:

[Enabled](#)

Enable the functions for Agent.

Disabled

Disable the functions for Agent.

[Read-Only]

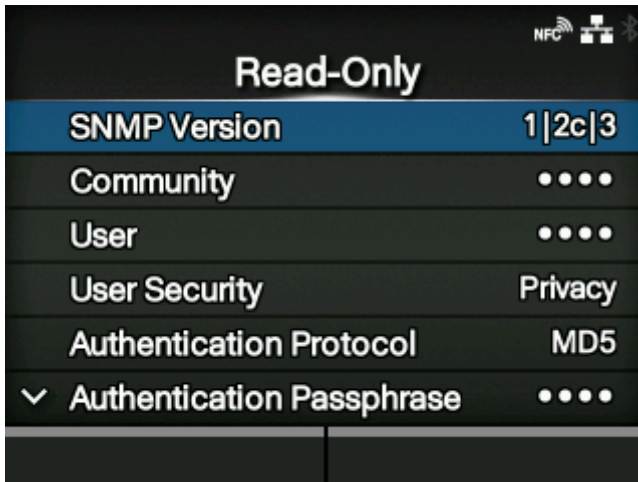

Set the read-only function.

The setting items are as follows:

[SNMP Version](#)

Set the SNMP version.

[Community](#)

Set the read-only community name.

- Appears only if you have selected [1|2c|3] or [1|2c] in the [SNMP Version] menu.

[User](#)

Set the read-only user name.

- Appears only if you have selected [1|2c|3] or [3] in the [SNMP Version] menu.

[User Security](#)

Set the read-only security level.

- Appears only if you have selected [1|2c|3] or [3] in the [SNMP Version] menu.

[Authentication Protocol](#)

Set the authentication protocol.

- Appears only if you have selected [Authentication] or [Privacy] in the [User Security] menu.

[Authentication Passphrase](#)

Set the authentication passphrase.

- Appears only if you have selected [Authentication] or [Privacy] in the [User Security] menu.

[Privacy Protocol](#)

Set the privacy protocol.

- Appears only if you have selected [Privacy] in the [User Security] menu.

[Privacy Passphrase](#)

Set the privacy passphrase.

- Appears only if you have selected [Privacy] in the [User Security] menu.

[SNMP Version]

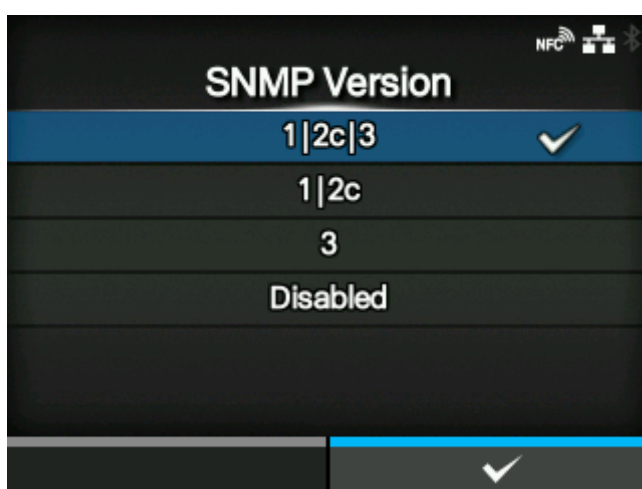

Set the SNMP version.

The options are as follows:

- [1|2c|3]
- [1|2c]
- [3]
- [Disabled]

[Community]

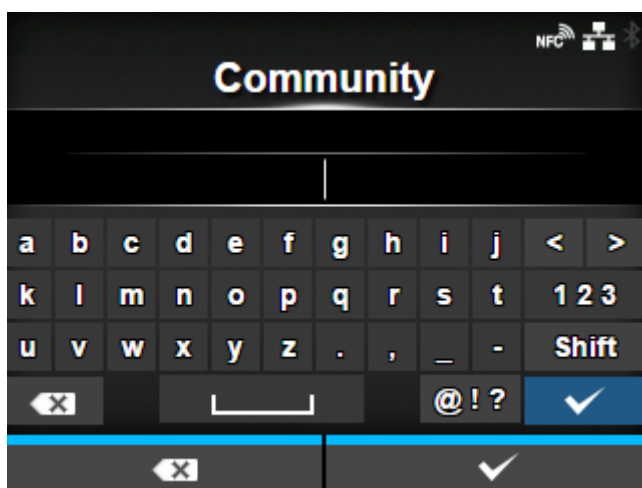

Set the read-only community name.

Appears only if you have selected [1|2c|3] or [1|2c] in the [SNMP Version] menu.

You can enter 1 to 32 characters. Alphabets, numbers and symbols can be used.

Initial setting: public

[User]

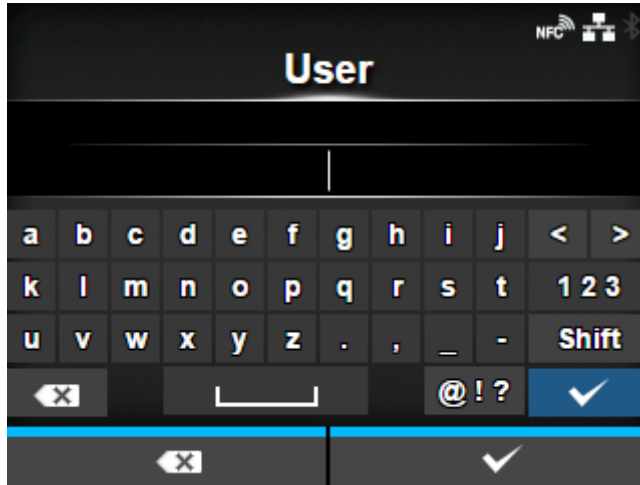

Set the read-only user name.

Appears only if you have selected [1|2c|3] or [3] in the [SNMP Version] menu.

You can enter 1 to 32 characters. Alphabets, numbers and symbols can be used.

Initial setting: rouser

[User Security]

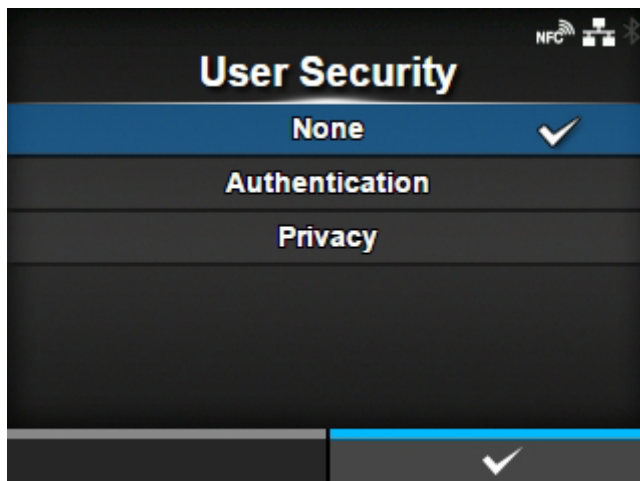

Set the read-only security level.

Appears only if you have selected [1|2c|3] or [3] in the [SNMP Version] menu.

The options are as follows:

- [None]
- [Authentication]
- [Privacy]

[Authentication Protocol]

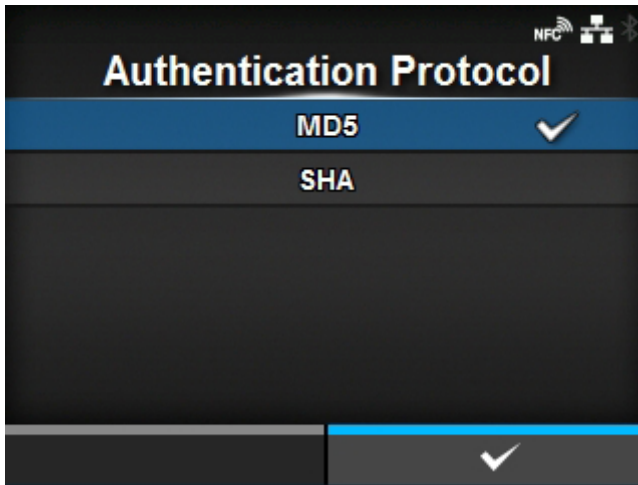

Set the authentication protocol.

Appears only if you have selected [Authentication] or [Privacy] in the [User Security] menu.

The options are as follows:

- [MD5]
- [SHA]

[Authentication Passphrase]



Set the authentication passphrase.

Appears only if you have selected [Authentication] or [Privacy] in the [User Security] menu.

You can enter 8 to 32 characters. Alphabets, numbers and symbols can be used.

Initial setting: mypassword

[Privacy Protocol]

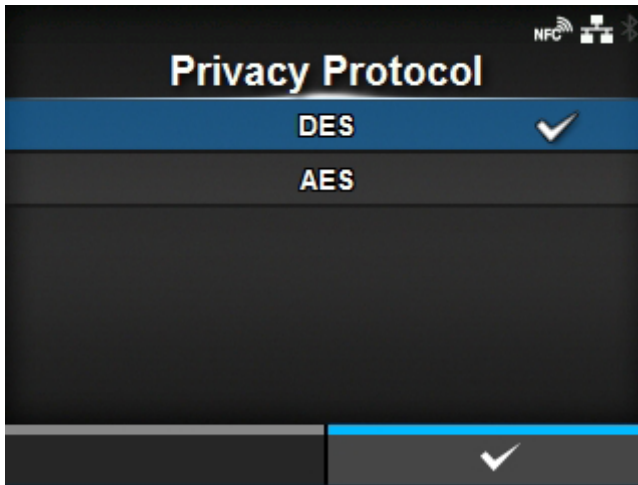

Set the privacy protocol.

Appears only if you have selected [Privacy] in the [User Security] menu.

The options are as follows:

- [DES]
- [AES]

[Privacy Passphrase]



Set the privacy passphrase.

Appears only if you have selected [Privacy] in the [User Security] menu.

You can enter 8 to 32 characters. Alphabets, numbers and symbols can be used.

Initial setting: mypassword

[Read-Write]

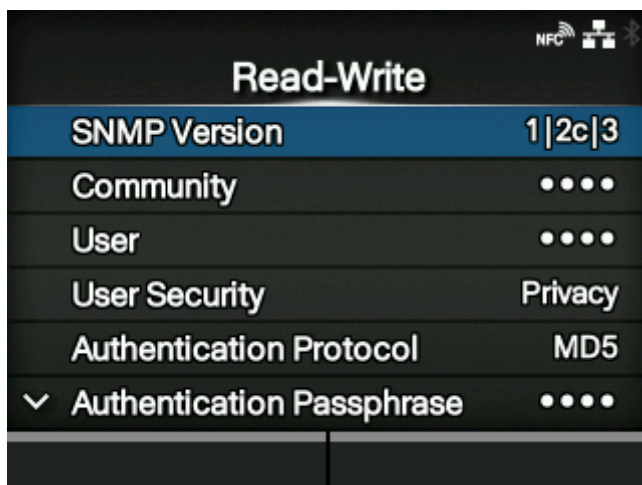

Set the read-write function.

The setting items are as follows:

[SNMP Version](#)

Set the SNMP version.

[Community](#)

Set the read-write community name.

- Appears only if you have selected [1|2c|3] or [1|2c] in the [SNMP Version] menu.

[User](#)

Set the read-write user name.

- Appears only if you have selected [1|2c|3] or [3] in the [SNMP Version] menu.

[User Security](#)

Set the read-write security level.

- Appears only if you have selected [1|2c|3] or [3] in the [SNMP Version] menu.

[Authentication Protocol](#)

Set the authentication protocol.

- Appears only if you have selected [Authentication] or [Privacy] in the [User Security] menu.

[Authentication Passphrase](#)

Set the authentication passphrase.

- Appears only if you have selected [Authentication] or [Privacy] in the [User Security] menu.

[Privacy Protocol](#)

Set the privacy protocol.

- Appears only if you have selected [Privacy] in the [User Security] menu.

[Privacy Passphrase](#)

Set the privacy passphrase.

- Appears only if you have selected [Privacy] in the [User Security] menu.

[SNMP Version]

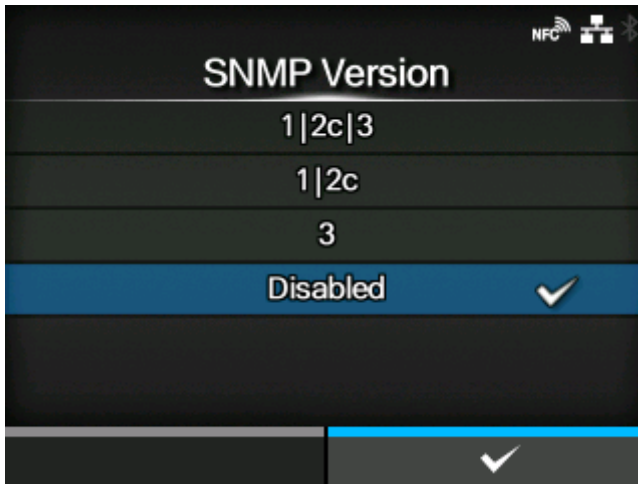

Set the SNMP version.

The options are as follows:

- [1|2c|3]
- [1|2c]
- [3]
- [Disabled]

[Community]

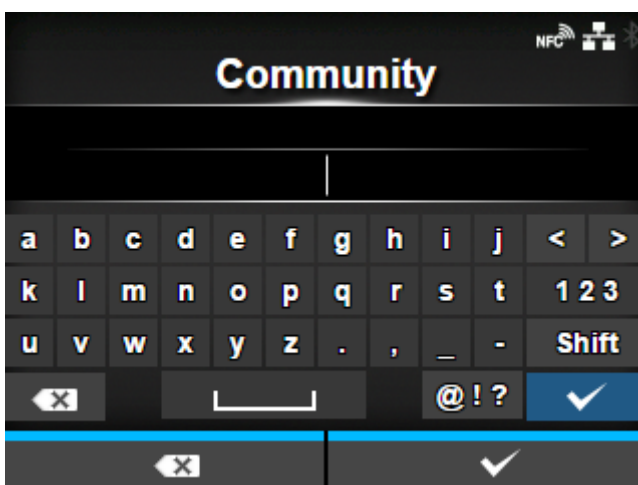

Set the read-write community name.

Appears only if you have selected [1|2c|3] or [1|2c] in the [SNMP Version] menu.

You can enter 1 to 32 characters. Alphabets, numbers and symbols can be used.

Initial setting: private

[User]

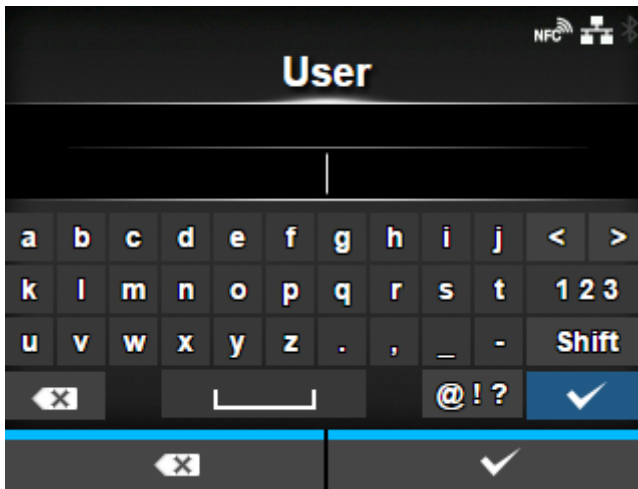

Set the read-write user name.

Appears only if you have selected [1|2c|3] or [3] in the [SNMP Version] menu.

You can enter 1 to 32 characters. Alphabets, numbers and symbols can be used.

Initial setting: rwuser

[User Security]

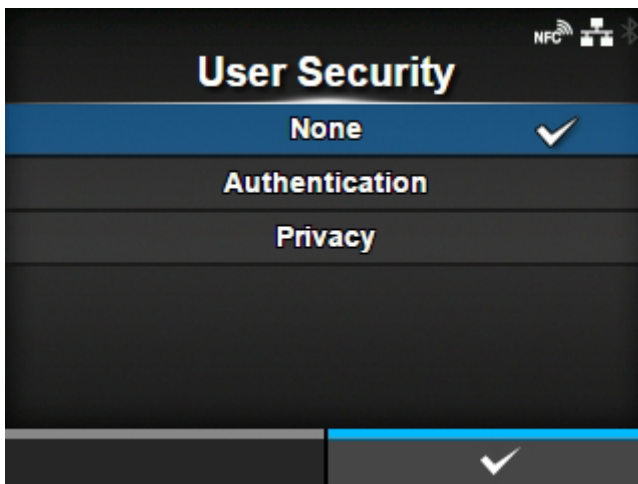

Set the read-write security level.

Appears only if you have selected [1|2c|3] or [3] in the [SNMP Version] menu.

The options are as follows:

- [None]
- [Authentication]
- [Privacy]

[Authentication Protocol]

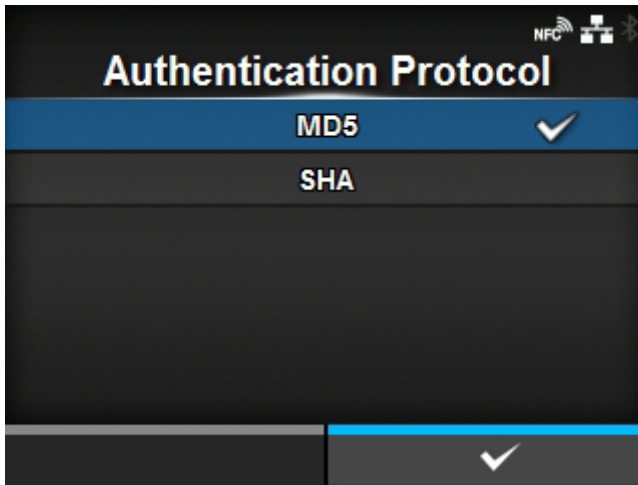

Set the authentication protocol.

Appears only if you have selected [Authentication] or [Privacy] in the [User Security] menu.

The options are as follows:

- [MD5]
- [SHA]

[Authentication Passphrase]



Set the authentication passphrase.

Appears only if you have selected [Authentication] or [Privacy] in the [User Security] menu.

You can enter 8 to 32 characters. Alphabets, numbers and symbols can be used.

Initial setting: mypassword

[Privacy Protocol]

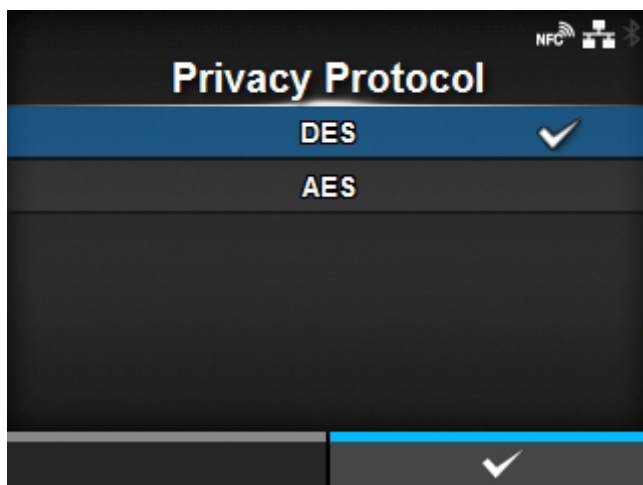

Set the privacy protocol.

Appears only if you have selected [Privacy] in the [User Security] menu.

The options are as follows:

- [DES]
- [AES]

[Privacy Passphrase]



Set the privacy passphrase.

Appears only if you have selected [Privacy] in the [User Security] menu.

You can enter 8 to 32 characters. Alphabets, numbers and symbols can be used.

Initial setting: mypassword

[Traps]

If [SNMP Version] is [1]

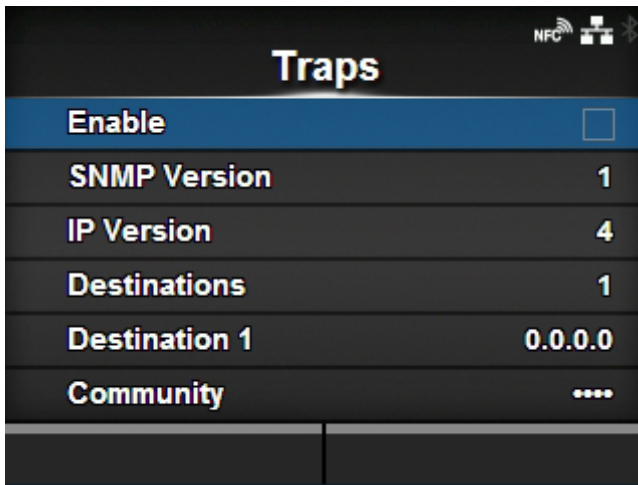

If [SNMP Version] is [3]

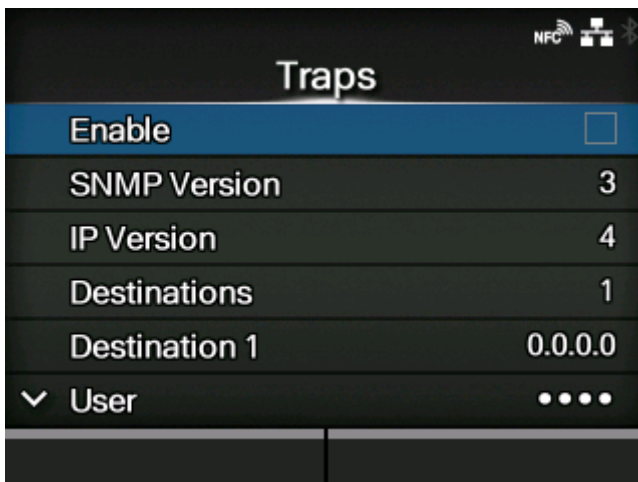

If [Security] is [Privacy]

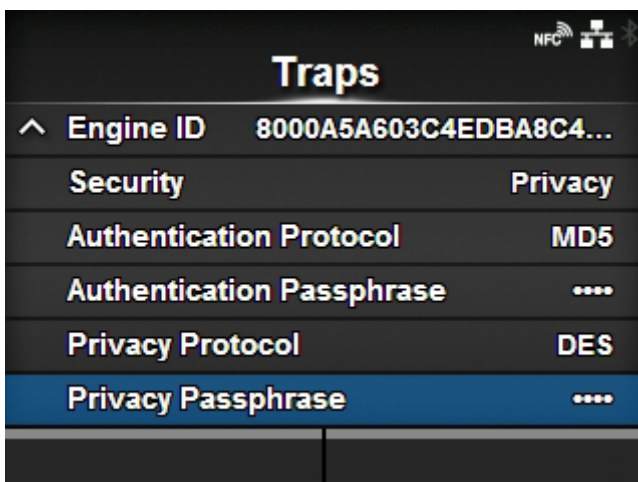

Set the Traps function.

The setting items are as follows:

[Enable](#)

Enable the Traps function.

[SNMP Version](#)

Set the SNMP version.

[IP Version](#)

Set the IP version to use for trap destinations.

[Destinations](#)

Set the number of trap destinations.

[Destination 1](#)

Set address 1 for the trap destination.

[Destination 2](#)

Set address 2 for the trap destination.

- Appears only if you have selected [2] or [3] in the [Destinations] menu.

[Destination 3](#)

Set address 3 for the trap destination.

- Appears only if you have selected [3] in the [Destinations] menu.

[Community](#)

Set the Traps community name.

- Appears only if you have selected [1] or [2c] in the [SNMP Version] menu.

[User](#)

Set the Traps user name.

- Appears only if you have selected [3] in the [SNMP Version] menu.

[Engine ID](#)

Set the engine ID.

- Appears only if you have selected [3] in the [SNMP Version] menu.

[Security](#)

Set the security level.

- Appears only if you have selected [3] in the [SNMP Version] menu.

[Authentication Protocol](#)

Set the authentication protocol.

- Appears only if you have selected [Authentication] or [Privacy] in the [Security] menu.

[Authentication Passphrase](#)

Set the authentication passphrase.

- Appears only if you have selected [Authentication] or [Privacy] in the [Security] menu.

[Privacy Protocol](#)

Set the privacy protocol.

- Appears only if you have selected [Privacy] in the [Security] menu.

[Privacy Passphrase](#)

Set the privacy passphrase.

- Appears only if you have selected [Privacy] in the [Security] menu.

[\[Enable\]](#)

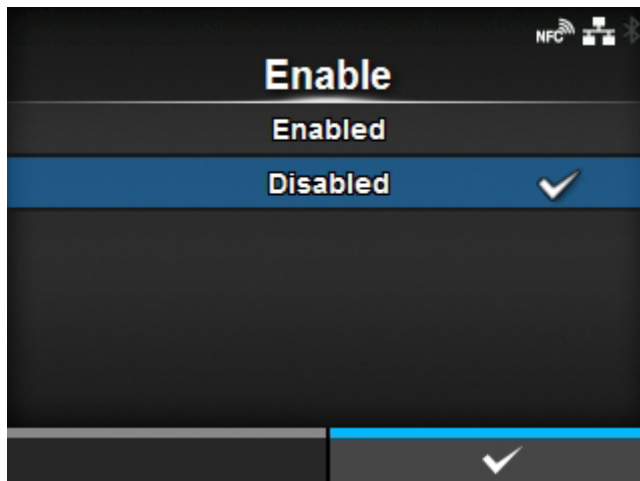

Enable or disable the functions for Traps.

The options are as follows:

Enabled

Enable the Traps function.

Disabled

Disable the Traps function.

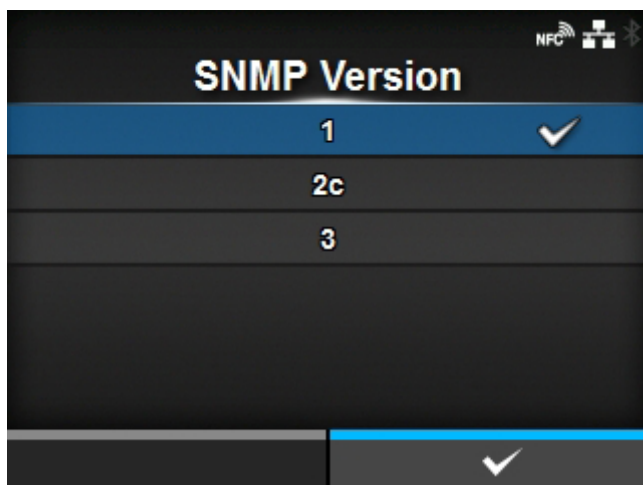
[SNMP Version]

Set the SNMP version.

The options are as follows:

- [1]
- [2c]
- [3]

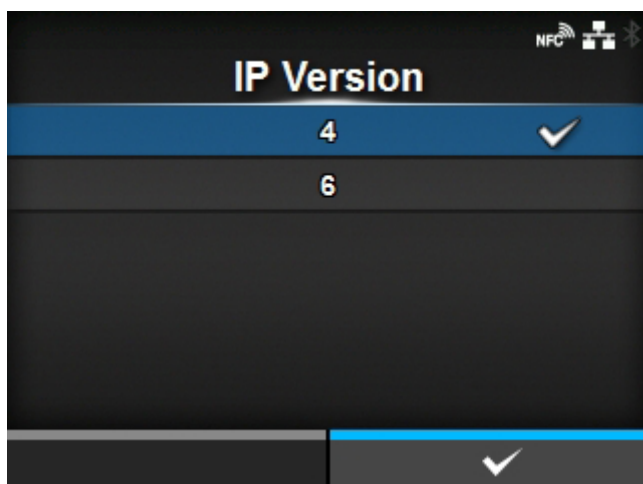
[IP Version]

Set the IP version to use for trap destinations.

The options are as follows:

4

Set the IP version to IPv4.

6

Set the IP version to IPv6.

[Destinations]

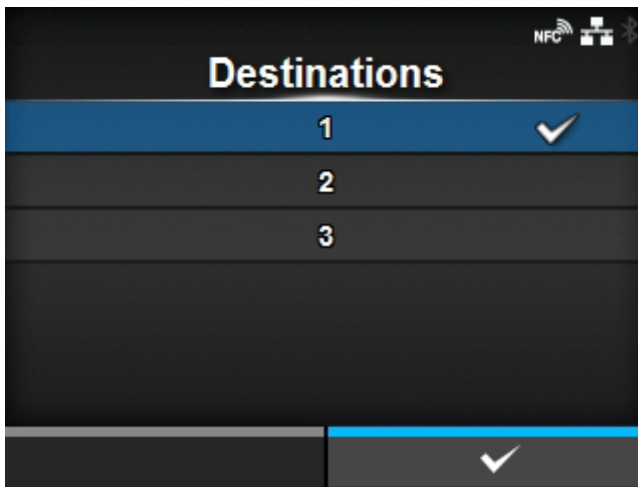

Set the number of trap destinations.

The setting range is from 1 to 3.

[Destination 1]

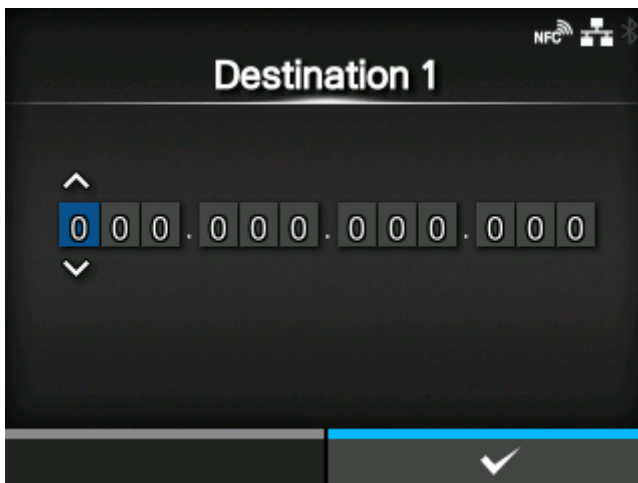

Set address 1 for the trap destination.

The displayed IP version differs depending on the [IP Version] setting.

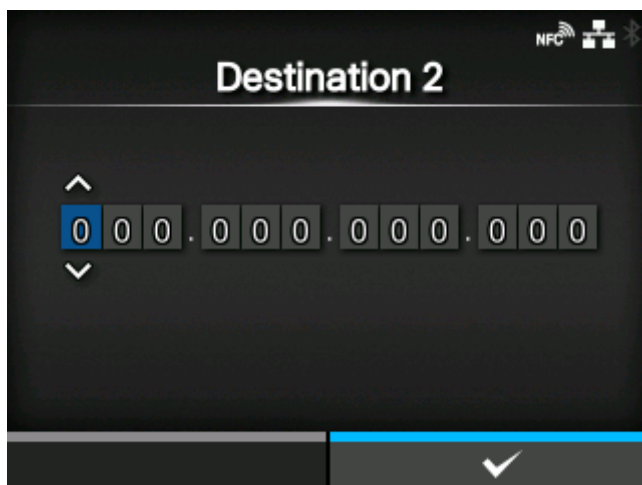
[Destination 2]

Set address 2 for the trap destination.

The displayed IP version differs depending on the [IP Version] setting.
Appears only if you have selected [2] or [3] in the [Destinations] menu.

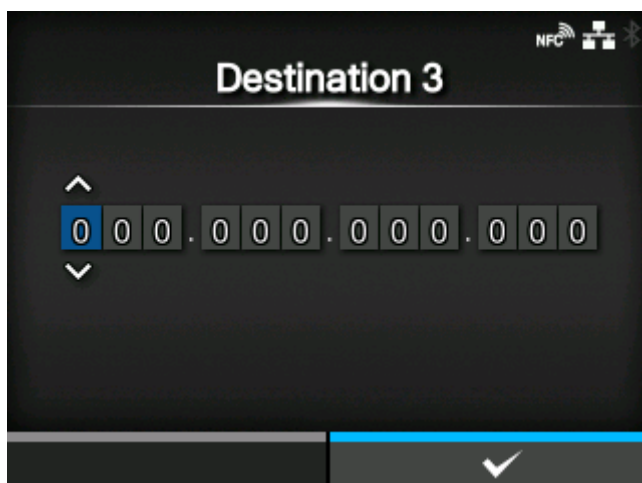
[Destination 3]

Set address 3 for the trap destination.

The displayed IP version differs depending on the [IP Version] setting.
Appears only if you have selected [3] in the [Destinations] menu.

[Community]

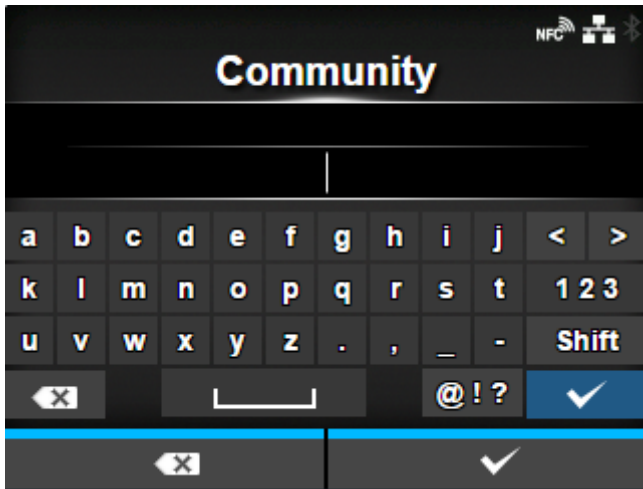

Set the Traps community name.

Appears only if you have selected [1] or [2c] in the [SNMP Version] menu.

You can enter 1 to 32 characters. Alphabets, numbers and symbols can be used.

Initial setting: trapcom

[User]



Set the Traps user name.

Appears only if you have selected [3] in the [SNMP Version] menu.

You can enter 1 to 32 characters. Alphabets, numbers and symbols can be used.

Initial setting: trapuser

[Engine ID]

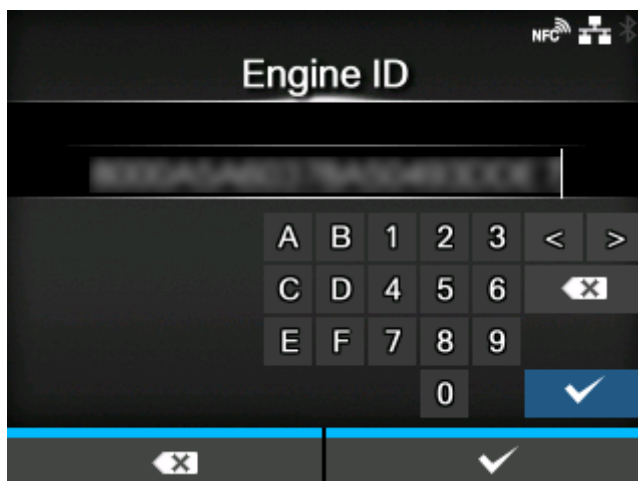

Set the engine ID.

Appears only if you have selected [3] in the [SNMP Version] menu.

Initial setting: Created from the MAC address.

Hexadecimal characters are allowed and the range is from 10 to 64 characters. (Only an even number of characters is allowed.)

[Security]

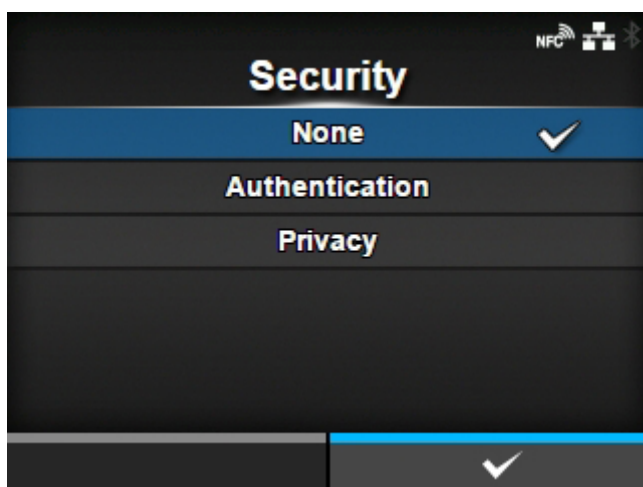

Set the security level.

Appears only if you have selected [3] in the [SNMP Version] menu.

The options are as follows:

- [None]
- [Authentication]
- [Privacy]

[Authentication Protocol]

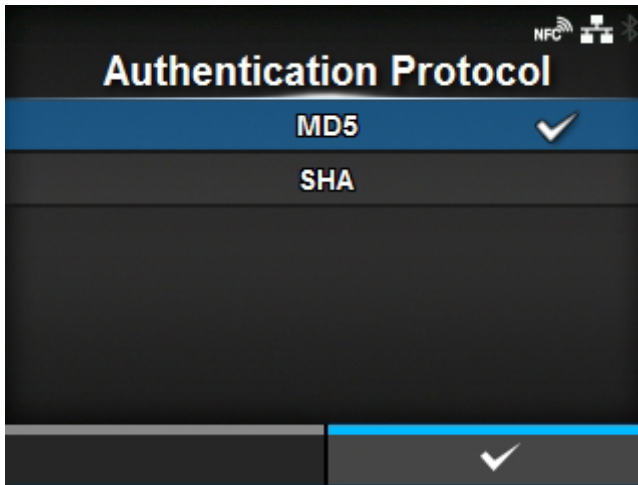

Set the authentication protocol.

Appears only if you have selected [Authentication] or [Privacy] in the [Security] menu.

The options are as follows:

- [MD5]
- [SHA]

[Authentication Passphrase]



Set the authentication passphrase.

Appears only if you have selected [Authentication] or [Privacy] in the [Security] menu.

You can enter 8 to 32 characters. Alphabets, numbers and symbols can be used.

Initial setting: mypassword

[Privacy Protocol]

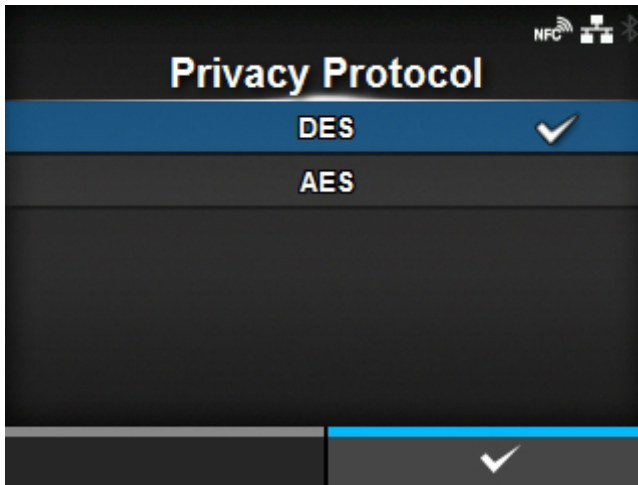

Set the privacy protocol.

Appears only if you have selected [Privacy] in the [Security] menu.

The options are as follows:

- [DES]
- [AES]

[Privacy Passphrase]



Set the privacy passphrase.

Appears only if you have selected [Privacy] in the [Security] menu.

You can enter 8 to 32 characters. Alphabets, numbers and symbols can be used.

Initial setting: mypassword

[Online Services] (SOS users only)

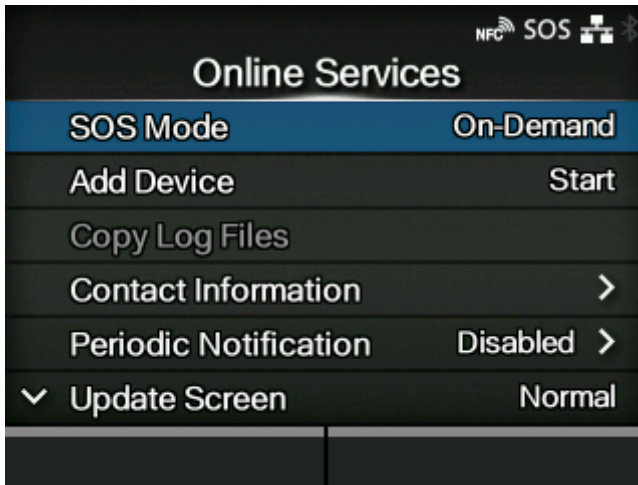

Set the functions for SOS (SATO Online Services).

To use SOS, it is necessary to first create an SOS account and add the product.

For details on the SOS, refer to the SOS portal site.

<https://www.sato-sos.com/en/>

The setting items are as follows:

[SOS Mode](#)

Select the mode of SOS (SATO Online Services) or disable SOS.

[Allow Remote Control](#)

Set whether or not to allow setting the product (remote control) from SOS (SATO Online Services).

- Appears only if you have selected [Real-Time] in the [SOS Mode] menu.

[MQTT Protocol](#)

Set the communication protocol of MQTT.

- Appears only if you have selected [Real-Time] in the [SOS Mode] menu.

[Add Device](#)

Shows the serial number and association code that are necessary when adding the product to SOS (SATO Online Services).

- Appears only if you have selected something other than [Disabled] in the [SOS Mode] menu.

[Copy Log Files](#)

Copies an SOS log file to USB memory.

- Appears only if you have selected something other than [Disabled] in the [SOS Mode] menu. It is available only when the log data is in the product and the USB memory is inserted into the product.

[Contact Information](#)

Sets the SOS (SATO Online Services) contact information that is displayed at the time of the error outbreak.

- Appears only if you have selected something other than [Disabled] in the [SOS Mode] menu.

[Periodic Notification](#)

Sets the function for periodic SOS (SATO Online Services) notifications.

A specialized application is required to scan the QR code.

- Appears only if you have selected [On-Demand] in the [SOS Mode] menu.

[Update Screen](#)

Sets whether to print a QR code displayed with SOS (SATO Online Services) periodic notification or Daily Checkup.

A specialized application is required to scan the QR code.

- Appears only if you have selected [On-Demand] in the [SOS Mode] menu.

[QR code offset](#)

Adjust the print position for printing a QR code displayed on the notification screen for SOS (SATO Online Services).

- Appears only if you have selected [On-Demand] in the [SOS Mode] menu. Available if you have selected [Print] in the [Update Screen] menu.

[Daily Checkup](#)

Shows the current product information with a QR code. Scan the QR code with a tablet or smartphone, and send it to the SOS cloud.

Also, the product information can be acquired via NFC and sent to the SOS cloud.

A specialized application is required to scan the QR code or send the product information to the SOS cloud.

- Appears only if you have selected [On-Demand] in the [SOS Mode] menu.

[SOS Mode] (SOS users only)

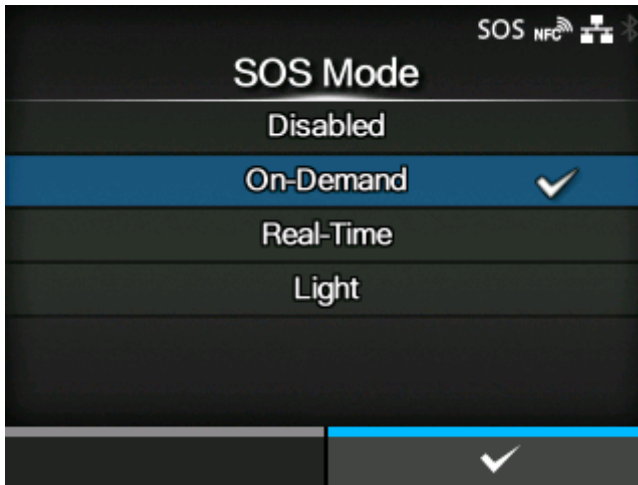

Select the mode of SOS (SATO Online Services) or disable SOS.

The options are as follows:

Disabled

Disables SOS.

On-Demand

Shows the product information with a QR code. Scan the displayed QR code with a tablet or smartphone and send the information to the SOS cloud. Also, the product information can be acquired via NFC and sent to the SOS cloud. This connection allows you to check the product's operating information via SOS Web. A specialized SOS application is required to scan the QR code or send the product information to the SOS cloud.

Real-Time

Sends the product information to the SOS cloud in real-time using the LAN/wireless LAN connection. This connection allows you to check the product's operating information and to check or modify the product's settings via SOS Web. Confirm and agree with the Terms of Use to enable the Real-Time mode.

Light

Sends the product information to the SOS cloud in real-time using the LAN/wireless LAN connection. This connection allows you to check the product's operating information via SOS Web.

[Allow Remote Control] (SOS users only)



Set whether or not to allow setting the product (remote control) from SOS (SATO Online Services).

Appears only if you have selected [Real-Time] in the [SOS Mode] menu.

The options are as follows:

Deny

Does not allow remote control from SOS.

Until Reboot

Allows remote control from SOS until the product reboots.

Always

Always allows remote control from SOS.

[MQTT Protocol] (SOS users only)

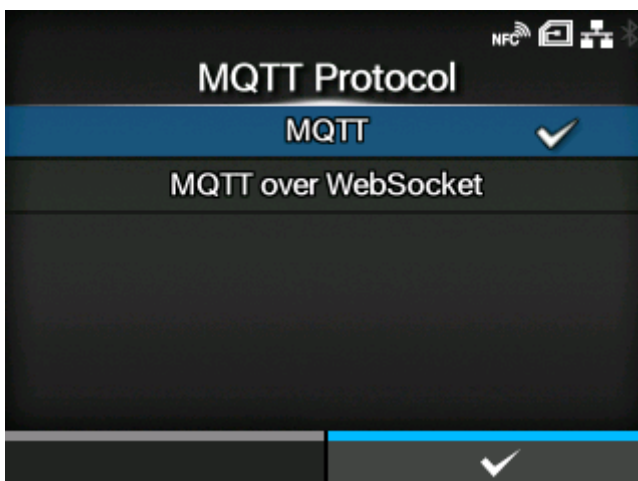

Set the communication protocol of MQTT.

Appears only if you have selected [Real-Time] in the [SOS Mode] menu.

The options are as follows:

MQTT

Set this to use port number 443 and 8883 to do MQTT communication.

MQTT over WebSocket

Set this to use port number 443 only to do MQTT communication. A proxy server cannot be used.

[Add Device] (SOS users only)

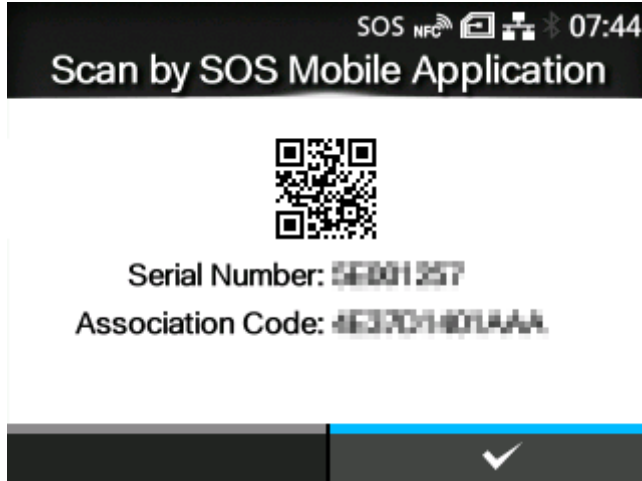

Shows the serial number and association code that are necessary when adding the product to SOS (SATO Online Services).

Appears only if you have selected something other than [Disabled] in the [SOS Mode] menu.



- Regarding the procedure to add a product to SOS, refer to the printer setup manual. https://www.sato-sos.com/en/support/#print_preparation_manual
- If authentication with the server fails, a screen like the one shown below appears. The message differs depending on the cause. Close the message according to the instructions displayed on the screen and contact your network administrator about the network settings.

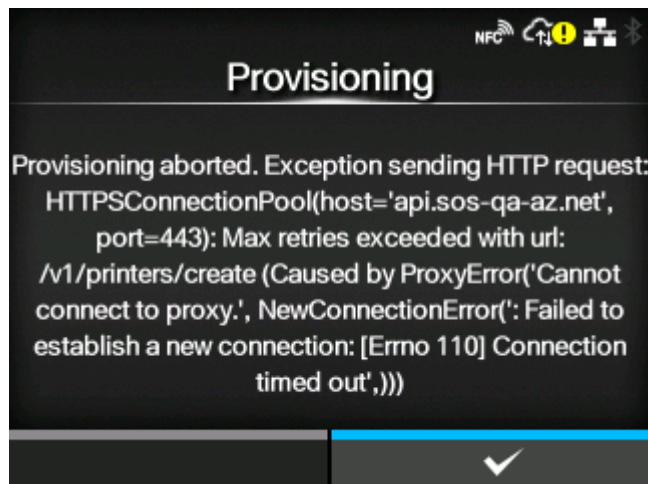

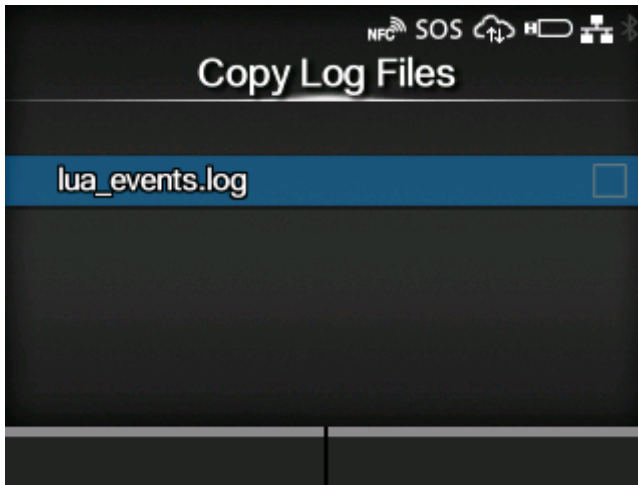
[Copy Log Files] (SOS users only)

Copies SOS (SATO Online Services) log files to USB memory.



Appears if you have selected something other than [Disabled] in the [SOS Mode] menu.

It is available only when the log data is in the product and the USB memory is inserted into the product.



- Be sure to perform a virus check on the USB memory before connecting it to the product. SATO Corporation shall not be held responsible for any product malfunctions caused by a virus spread via USB memory.

The procedure to copy the log file is as follows:

1. Select the file to copy and press the  button. A check mark is shown on the right side of the file name.
2. After you select the file, press the  button to copy the selected file to the USB memory.

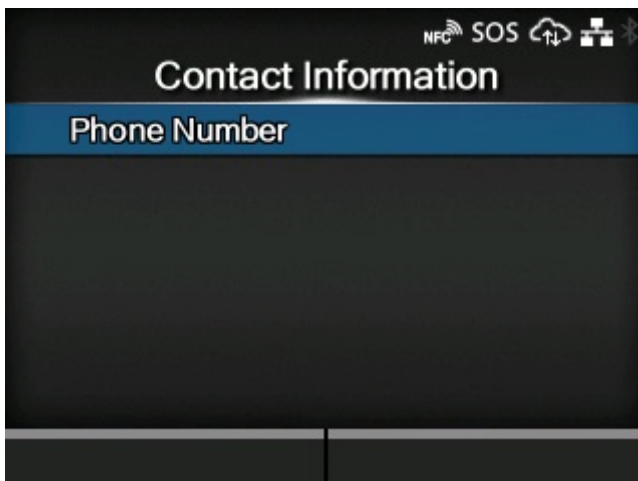
[Contact Information] (SOS users only)

Sets the SOS (SATO Online Services) contact information that is displayed at the time of the error outbreak.

Appears only if you have selected something other than [Disabled] in the [SOS Mode] menu.

The setting items are as follows:

[Phone Number](#)

Sets the phone number that is displayed on the SOS error screen when you select the SOS (SATO Online Services) icon on an error message screen.

[\[Phone Number\] \(SOS users only\)](#)

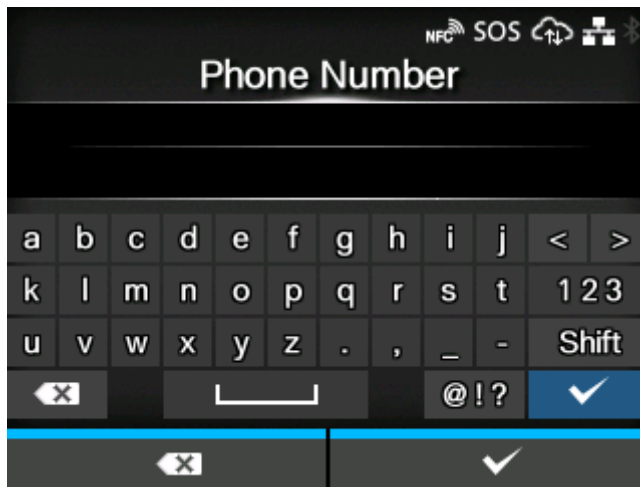

Sets the phone number that is displayed on the SOS error screen when you select the SOS (SATO Online Services) icon on an error message screen.

Up to 20 characters can be set.

[\[Periodic Notification\] \(SOS users only\)](#)

When [Counter] is set with [Head] in the [Type] menu

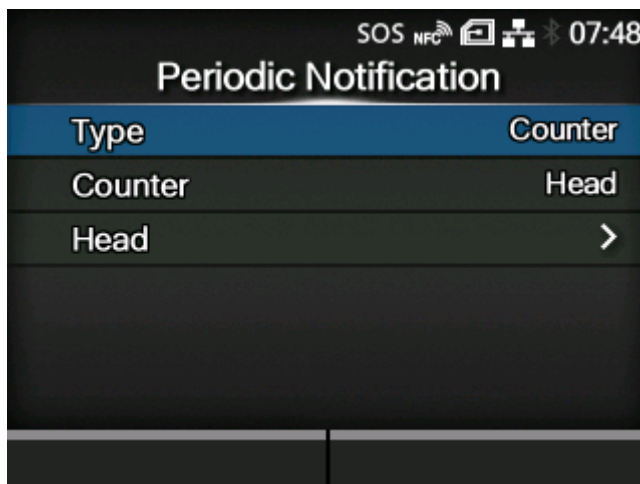

Sets the function for periodic SOS (SATO Online Services) notifications.

Appears only if you have selected [On-Demand] in the [SOS Mode] menu.

In this function, the product information is shown periodically with a QR code. Scan the displayed QR code with a tablet or smartphone, and send the information to the SOS cloud.

A specialized application is required to scan the QR code.

The setting items are as follows:

[Type](#)

Select the timing to perform the periodic notification or disable this function.

[Counter](#)

You can select the counter for the print head, cutter, or both for the timing to perform periodic notifications.

- Appears only if you have selected [Counter] in the [Type] menu.

[Head](#)

You can specify or check the print distance of the print head for the timing to perform the periodic notification.

- Appears only if you have set [Counter] with [Head] or [Head+Cutter] in the [Type] menu.

[Cutter](#)

You can specify or check the number of cut times of the cutter for the timing to perform the periodic notification.

- Appears only if you have set [Counter] with [Cutter] or [Head+Cutter] in the [Type] menu.

[Notifications](#)

Specifies the number of periodic notifications to be sent per day.

- Appears only if you have enabled the NTP function or installed the optional RTC kit, and if you have selected [Daily] in the [Type] menu.

[Weekday](#)

Specifies the day of the week to perform the periodic notification.

- Appears only if you have enabled the NTP function or installed the optional RTC kit, and if you have selected [Weekly] in the [Type] menu.

[Day](#)

Sets the date to perform the periodic notification.

- Appears only if you have enabled the NTP function or installed the optional RTC kit, and if you have selected [Monthly] in the [Type] menu.

[Time 1](#)

Specifies the time to perform the first periodic notification.

- Appears only if you have enabled the NTP function or installed the optional RTC kit, and if you have selected [Daily] in the [Type] menu.

[Time 2](#)

Specifies the time to perform the second periodic notification.

- Appears only if you have enabled the NTP function or installed the optional RTC kit, and if you have selected [Daily] in the [Type] menu and have set more than two times for [Notifications].

Time 3

Specifies the time to perform the third periodic notification.

- Appears only if you have enabled the NTP function or installed the optional RTC kit, and if you have selected [Daily] in the [Type] menu and have set three times for [Notifications].

Time

Specifies the time of the specified day or date to perform periodic notifications.

- Appears only if you have enabled the NTP function or installed the optional RTC kit, and if you have selected [Weekly] or [Monthly] in the [Type] menu.

[Type] (SOS users only)

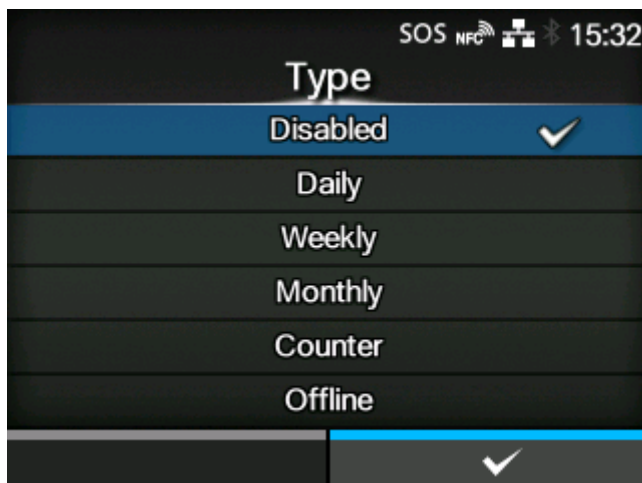

Select the timing to perform the periodic notification or disable this function.

Advanced setting items appear on the [Periodic Notification] menu according to the selected options.

The options are as follows:

Disabled

Disables the periodic notification function.

Daily

Displays the notification screen every day for specified number of times, at the specified time.

- Appears only if you have enabled the NTP function or installed the optional RTC kit.

Weekly

Displays the notification screen every week at the specified day of week and time.

- Appears only if you have enabled the NTP function or installed the optional RTC kit.

Monthly

Displays the notification screen every month at the specified day and time.

- Appears only if you have enabled the NTP function or installed the optional RTC kit.

Counter

Displays the notification screen when the counter of a consumable reaches to the specified value.

Offline

Displays the notification screen when the product is changed to Offline mode.

[Counter] (SOS users only)

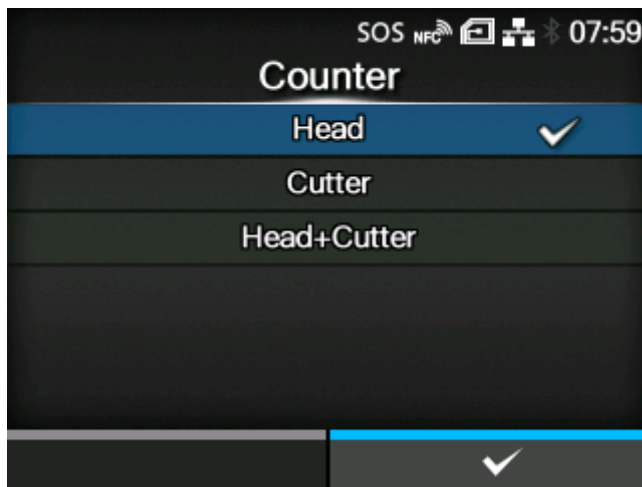

You can select the counter for the print head, cutter, or both for the timing to perform periodic notifications.

Appears only if you have selected [Counter] in the [Type] menu.

Advanced setting items appear on the [Periodic Notification] menu according to the selected options.

The options are as follows:

- [Head]
- [Cutter]
- [Head+Cutter]

[Head] (SOS users only)



You can specify or check the print distance of the print head for the timing to perform the periodic notification.

Appears only if you have selected [Head] or [Head+Cutter] for [Counter] in the [Type] menu.

The setting items are as follows:

Meters

Specifies the print distance of the print head for the timing to perform the periodic notification. You will be notified for every meter you specify.

Last Update

Shows the print distance of the print head for the last periodic notification.

Next Update

Shows the print distance of the print head for the next periodic notification.

Current Value

Shows the current print distance of the print head.

[Meters] (SOS users only)

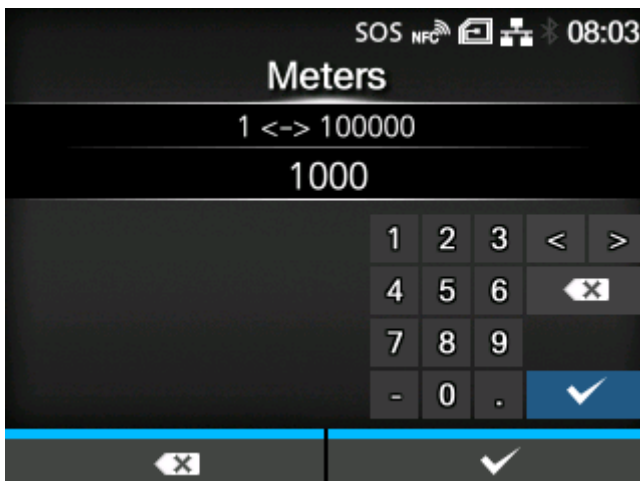

Specifies the print distance of the print head for the timing to perform the periodic notification. You will be notified for every meter you specify.

The setting range is from 1 to 100,000.

[Cutter] (SOS users only)



You can specify or check the number of cut times of the cutter for the timing to perform the periodic notification.

Appears only if you have selected [Cutter] or [Head+Cutter] for [Counter] in the [Type] menu.

The setting items are as follows:

Cuts

Specifies the number of cut times of the cutter for the timing to perform the periodic notification.

Last Update

Shows the number of cut times of the cutter for the last periodic notification.

Next Update

Shows the number of cut times of the cutter for the next periodic notification.

Current Value

Shows the current number of cut times of the cutter.

[Cuts] (SOS users only)

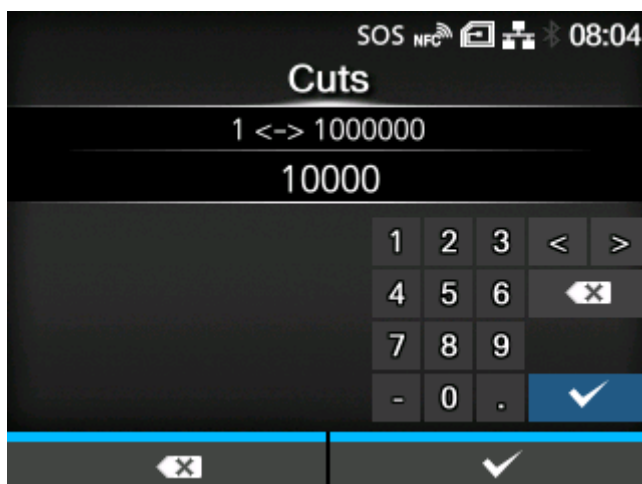

Specifies the number of cut times of the cutter for the timing to perform the periodic notification. You will be notified for each number of cut times you specify.

The setting range is from 1 to 1,000,000.

[Notifications] (SOS users only)

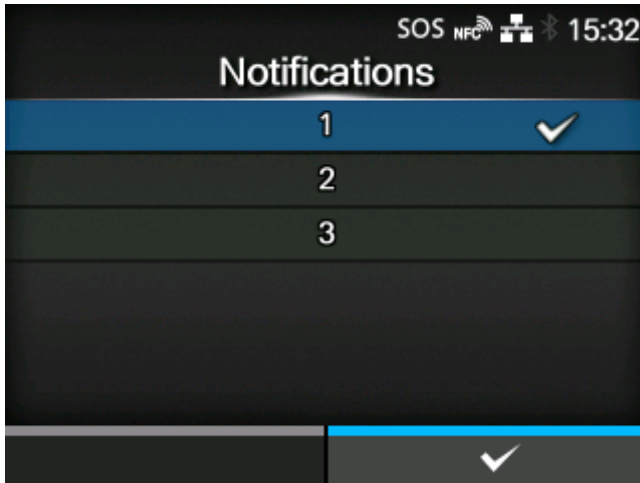

Specifies the number of periodic notifications to be sent per day.

Appears only if you have enabled the NTP function or installed the optional RTC kit, and if you have selected [Daily] in the [Type] menu.

The setting range is from 1 to 3.

[Weekday] (SOS users only)

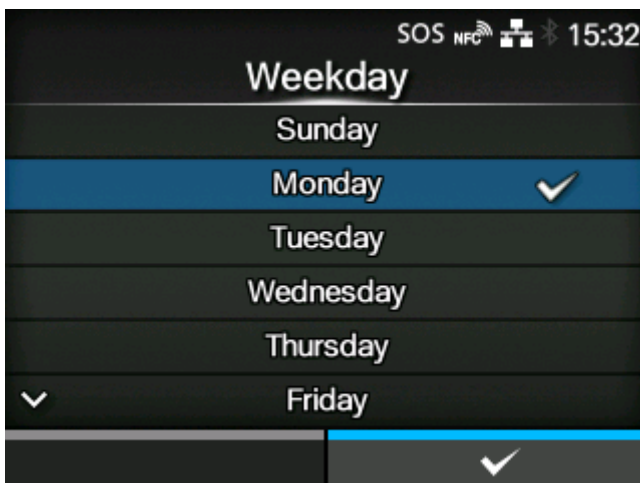

Specifies the day of the week to perform the periodic notification.

Appears only if you have enabled the NTP function or installed the optional RTC kit, and if you have selected [Weekly] in the [Type] menu.

The setting range is from Sunday to Saturday.

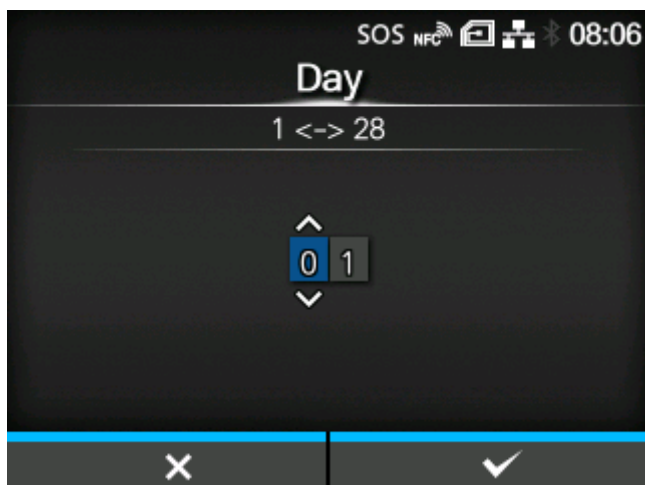
[Day] (SOS users only)

Sets the date to perform the periodic notification.

Appears only if you have enabled the NTP function or installed the optional RTC kit, and if you have selected [Monthly] in the [Type] menu.

The setting range is from 1 to 28.

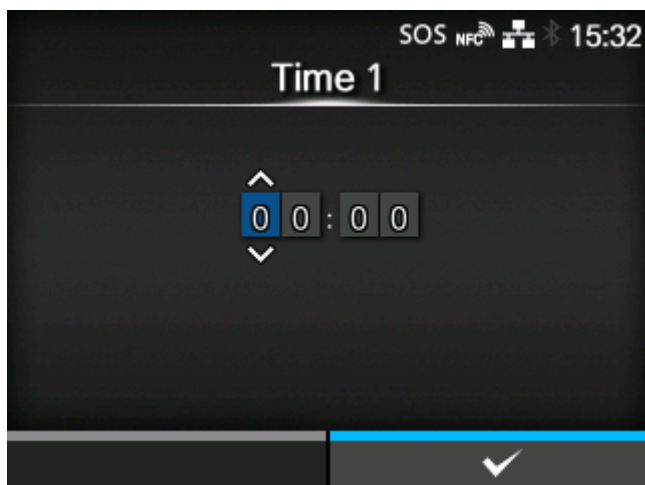
[Time 1] (SOS users only)

Specifies the time to perform the first periodic notification.

Appears only if you have enabled the NTP function or installed the optional RTC kit, and if you have selected [Daily] in the [Type] menu.

[Time 2] (SOS users only)

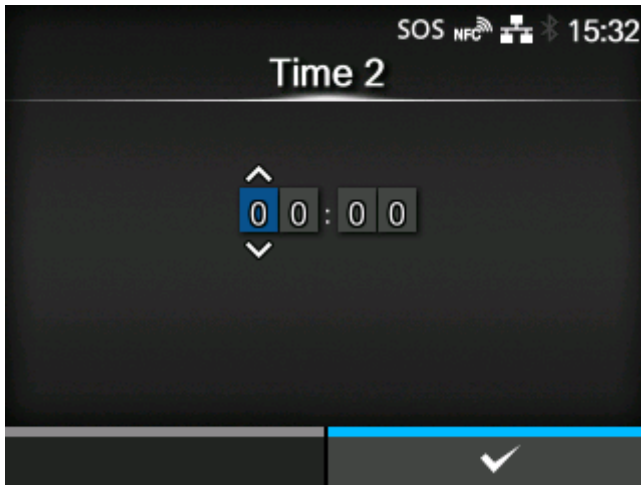

Specifies the time to perform the second periodic notification.

Appears only if you have enabled the NTP function or installed the optional RTC kit, and if you have selected [Daily] in the [Type] menu and have set more than two times for [Notifications].

[Time 3] (SOS users only)

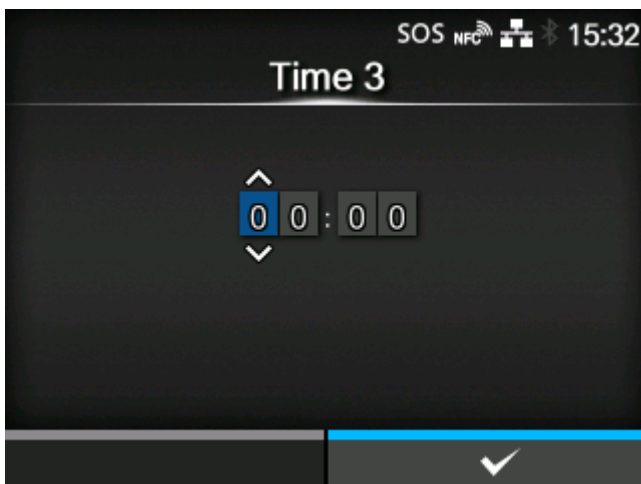

Specifies the time to perform the third periodic notification.

Appears only if you have enabled the NTP function or installed the optional RTC kit, and if you have selected [Daily] in the [Type] menu and have set three times for [Notifications].

[Time] (SOS users only)

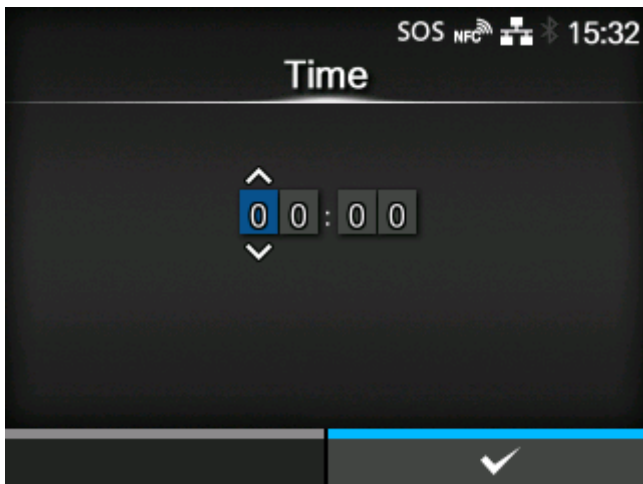

Specifies the time of the specified day or date to perform periodic notifications.

Appears only if you have enabled the NTP function or installed the optional RTC kit, and if you have selected [Weekly] or [Monthly] in the [Type] menu.

[Update Screen] (SOS users only)

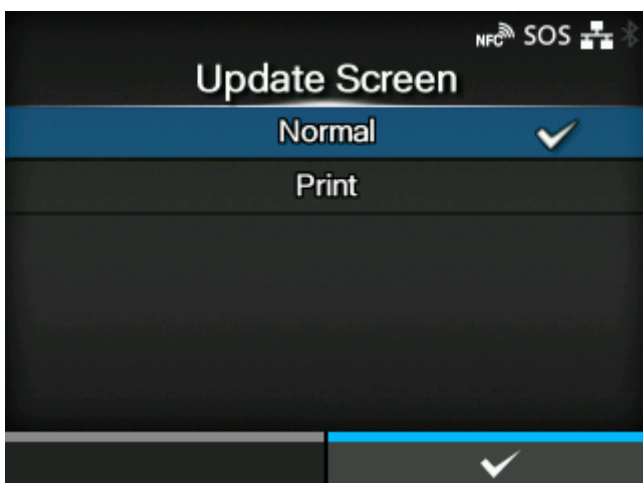

Sets whether to print a QR code displayed with SOS (SATO Online Services) periodic notification or Daily Checkup.

Appears only if you have selected [On-Demand] in the [SOS Mode] menu.

A specialized application is required to scan the QR code.

The options are as follows:

Normal

Shows the scan screen of a normal QR code.

Print

You can execute printing in the scan screen for the QR code. Press the  button to print the QR code.

To print the QR code, use media of more than 33 mm (1.3") in length and more than 33 mm (1.3") in width (not including the liner).

[QR code offset] (SOS users only)

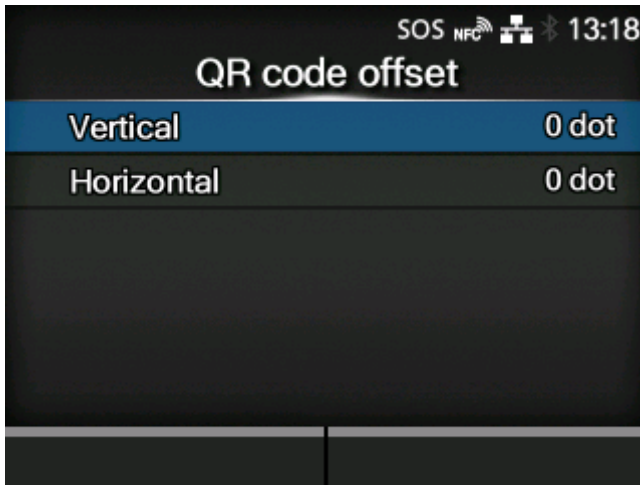

Adjust the print position for printing a QR code displayed on the notification screen for SOS (SATO Online Services).

Appears only if you have selected [On-Demand] in the [SOS Mode] menu.

Available only if you have selected [Print] in the [Update Screen] menu.

The options are as follows:

[Vertical](#)

Adjust the print position of the QR code in the vertical direction.

[Horizontal](#)

Adjust the print position of the QR code in the horizontal direction.

[Vertical] (SOS users only)

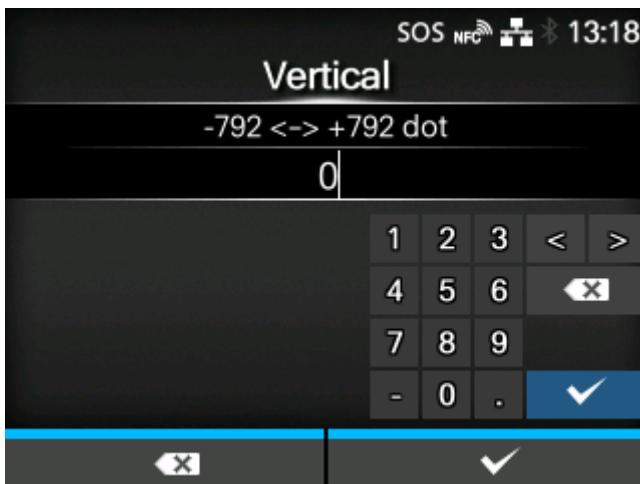

Adjust the print position of the QR code in the vertical direction.

Set the correction value from the print reference position as "-" for the direction of the paper feed and "+" for the direction opposite to the paper feed.

The setting range is from -792 to +792 dots.

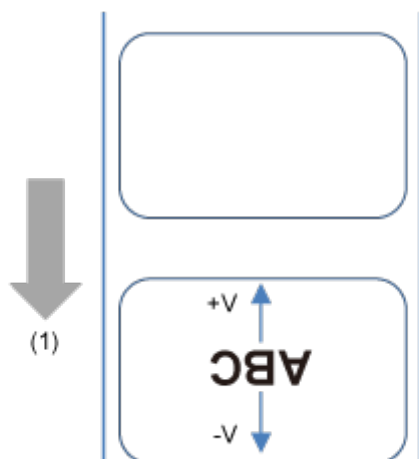

(1) Feed direction



- The length of 1 dot varies depending on the print resolution of the product.
 - 203 dpi : 1 dot = 0.125 mm (0.0049")
 - 305 dpi : 1 dot = 0.083 mm (0.0033")
 - 609 dpi : 1 dot = 0.042 mm (0.0017")

[Horizontal] (SOS users only)

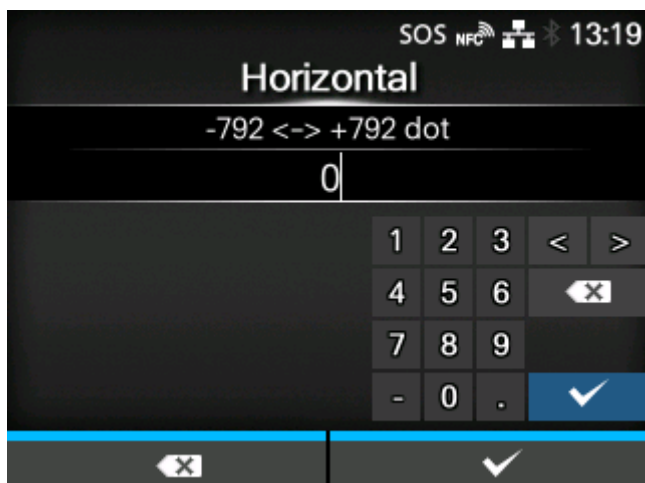

Adjust the print position of the QR code in the horizontal direction.

Set the correction value from the print reference position when facing the product as "-" to adjust to the right side and "+" to adjust to the left side.

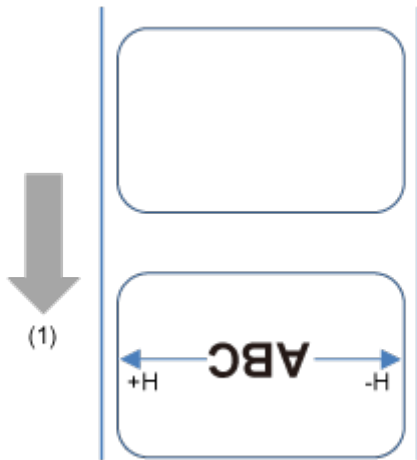

(1) Feed direction

The setting range is from -792 to +792 dots.



- The length of 1 dot varies depending on the print resolution of the product.
 - 203 dpi : 1 dot = 0.125 mm (0.0049")
 - 305 dpi : 1 dot = 0.083 mm (0.0033")
 - 609 dpi : 1 dot = 0.042 mm (0.0017")

[Daily Checkup] (SOS users only)

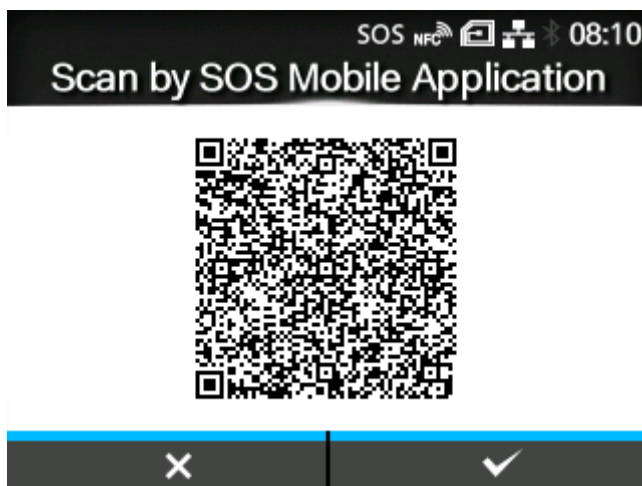

Shows the current product information with a QR code. Scan the QR code with a tablet or smartphone, and send it to the SOS cloud.

Also, the product information can be acquired via NFC and sent to the SOS cloud.

Appears only if you have selected [On-Demand] in the [SOS Mode] menu.

A specialized application is required to scan the QR code or send the product information to the SOS cloud.

If you have selected [Print] in the [Update Screen], press the  button to print the QR code.

To print the QR code, use media of more than 33 mm (1.3") in length and more than 33 mm (1.3") in width (not including the liner).

[Advanced]

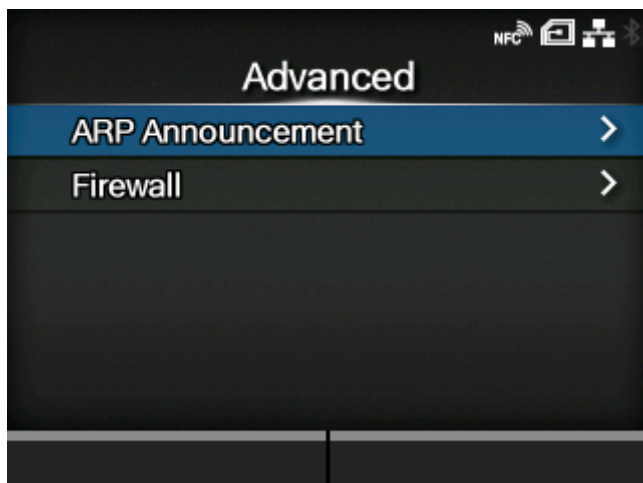

Set the advanced function for the interface.

The setting items are as follows:

[ARP Announcement](#)

Set the ARP announcement.

[Firewall](#)

Set the functions for the firewall.

[ARP Announcement]

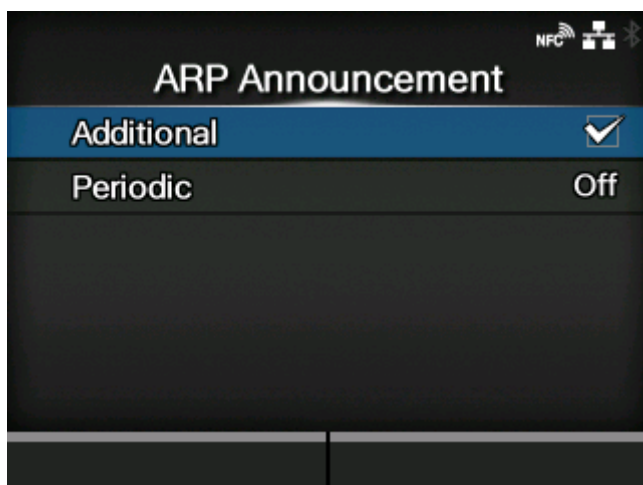

Set the functions for ARP announcement.

The ARP announcement is useful for updating other hosts mapping of a hardware address when the IP address or MAC address of the sender has changed.

The setting items are as follows:

[Additional](#)

Enable or disable the additional ARP announcement.

[Periodic](#)

Set the periodic timing for ARP announcement.

[Additional]

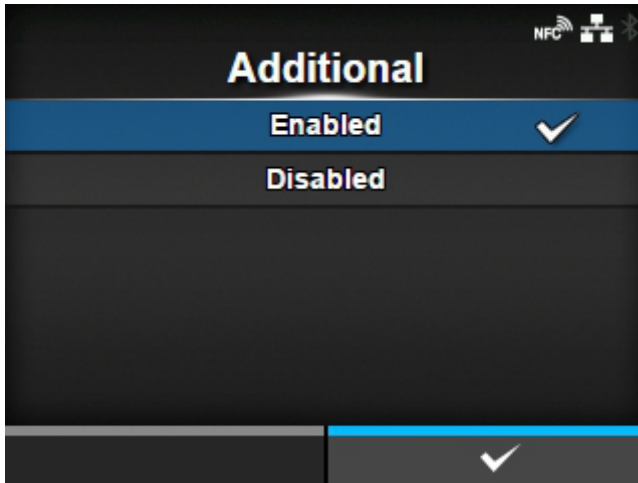

Set the additional ARP announcement.

The options are as follows:

Enabled

Enable the additional ARP announcement. The ARP is sent at 1, 2, 4, 8 and 16 seconds after the link up/DHCP assignment.

Disabled

Disable the additional ARP announcement. The ARP is only sent at 1 second after the link up/DHCP assignment.

[Periodic]

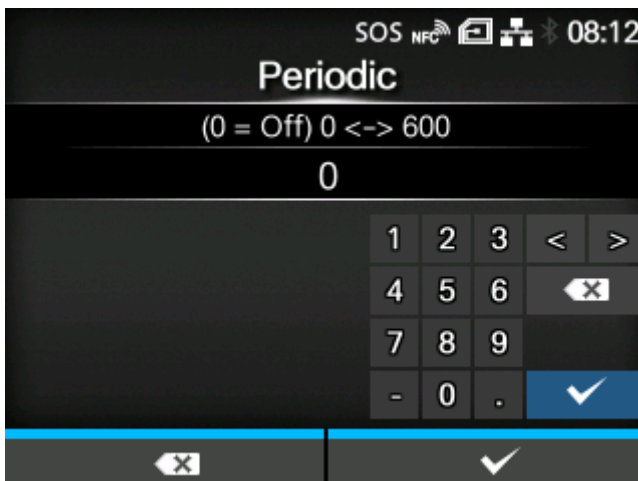

Set the interval of the ARP announcement in the range of 0 to 600 seconds.

Initial setting: 0

[Firewall]

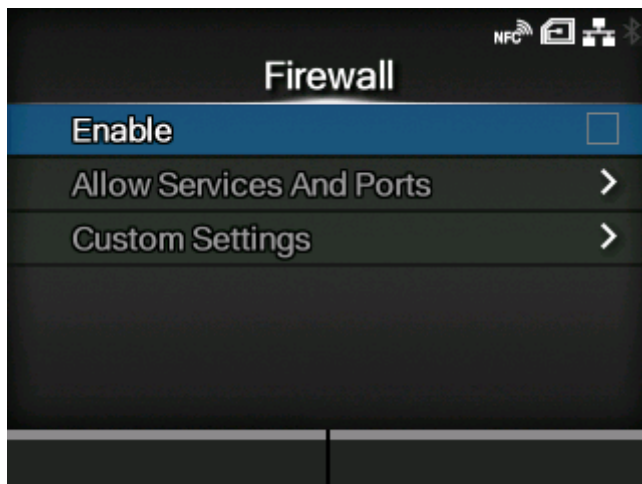

Set the functions for the firewall.

A firewall can improve security. It prevents unauthorized access from external computers or malicious programs. When the firewall is enabled, only the services and ports that are allowed will be able to access the product.



- As a basic policy of filtering, all OUTPUT is allowed (ACCEPT) and both INPUT and FORWARD are not allowed (DROP).
-

The setting items are as follows:

[Enable](#)

Enable or disable the firewall function.

[Allow Services And Ports](#)

Set the service or port to allow communication.

- Available only if you have selected [Enabled] in the [Enable] menu.

[Custom Settings](#)

Specify the ICMP type or the port number of TCP or UDP to allow communication.

- Available only if you have selected [Enabled] in the [Enable] menu.

[Enable]

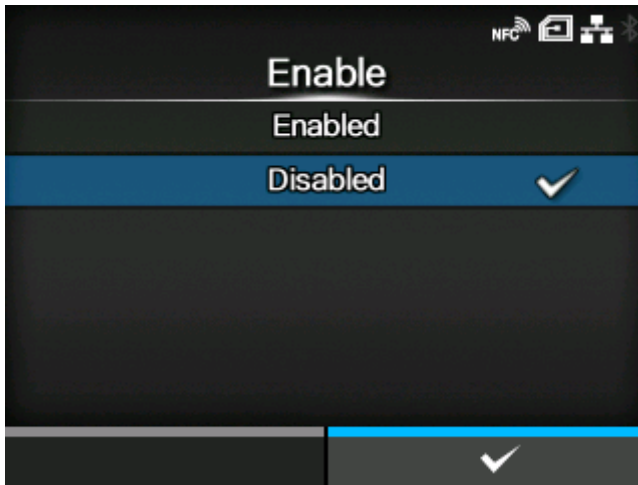

Enable or disable the firewall function.

The options are as follows:

Enabled

Enable the firewall function.

Disabled

Disable the firewall function.

[Allow Services And Ports]

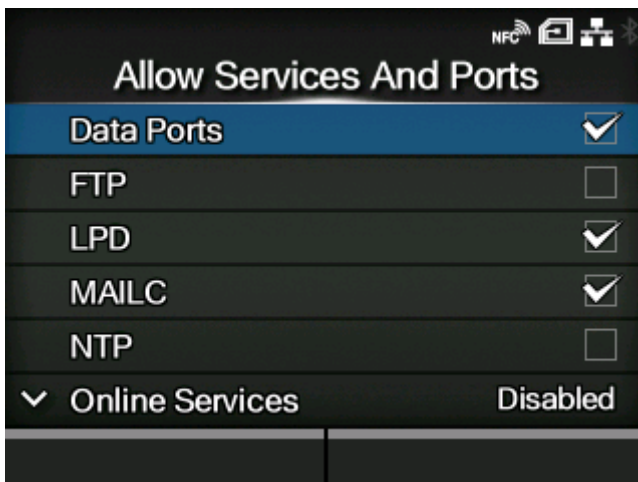

Set the service or port to allow communication.

Available only if you have selected [Enabled] in the [Enable] menu.



- The product becomes accessible only through services or ports that are allowed in [Allow Services And Ports].

The setting items are as follows:

Data Ports

Enable or disable access through data ports.

FTP

Enable or disable the functions for FTP.

The setting changes in conjunction with [Enable] in the [FTP] menu.

LPD

Enable or disable the LPD function.

The setting changes in conjunction with [Enable] in the [LPD] menu.

MAILC

When using the AEP (Application Enabled Printing) function, enable or disable port access for the product's internal e-mail client function.

NTP

Enable or disable the functions for NTP.

The setting changes in conjunction with [Enable] in the [NTP] menu.

Online Services

Selects the mode for SOS or disable SOS.

The setting changes in conjunction with [SOS Mode].

PING

Enable or disable PING access.

SATO All-In-One Tool

Enable or disable the access from SATO All-In-One Tool.

SCP

When using the AEP (Application Enabled Printing) function, enable or disable port access for the SCP client function.

SNMP Agent

Enable or disable the SNMP Agent function.

The setting changes in conjunction with [Enable] in the [Agent] menu.

WEBC

When using the AEP (Application Enabled Printing) function, enable or disable port access for the Web client function.

WebConfig

Enable or disable access to the web configuration page.

The below table shows the packet filtering setting for each allowed services and port setting.

[Allow Services And Ports]	[TCP Source Port]	[TCP Destination Port]	[UDP Source Port]	[UDP Destination Port]	[ICMP Type]
[Data Ports] *	-	1024,1025,9100	-	-	-
[FTP]	-	20,21	-	-	-
[LPD]	-	515	53	-	-
[MAILC]	465,587	-	53	-	-

[Allow Services And Ports]	[TCP Source Port]	[TCP Destination Port]	[UDP Source Port]	[UDP Destination Port]	[ICMP Type]
[NTP]	-	-	53,123	-	-
[Online Services]*	443,8883	-	53	-	-
[PING]	-	-	-	-	0,8
[SATO All-In-One Tool]	-	9100	-	161,19541	-
[SCP]	22	-	53	-	-
[SNMP Agent]	-	-	-	161	-
[WEBC]	80,443,8080	-	53	-	-
[WebConfig]	-	80,443	-	-	-

*The values may vary depending on other settings.

[Online Services] (SOS users only)

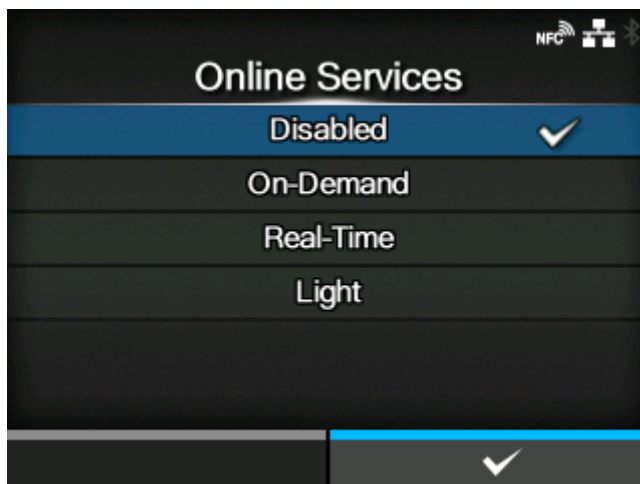

Select the mode of SOS (SATO Online Services) or disable SOS.

The options are as follows:

Disabled

Disables SOS.

On-Demand

Shows the product information with a QR code. Scan the displayed QR code with a tablet or smartphone and send the information to the SOS cloud. Also, the product information can be acquired via NFC and sent to the SOS cloud. This connection allows you to check the product's operating information via SOS Web. A specialized SOS application is required to scan the QR code or send the product information to the SOS cloud.

Real-Time

Sends the product information to the SOS cloud in real-time using the LAN/wireless LAN connection. This connection allows you to check the product's operating information and to check or modify the product's settings via SOS Web. Confirm and agree with the Terms of Use to enable the Real-Time mode.

Light

Sends the product information to the SOS cloud in real-time using the LAN/wireless LAN connection. This connection allows you to check the product's operating information via SOS Web.



- The setting changes in conjunction with [SOS Mode].
-

[Custom Settings]

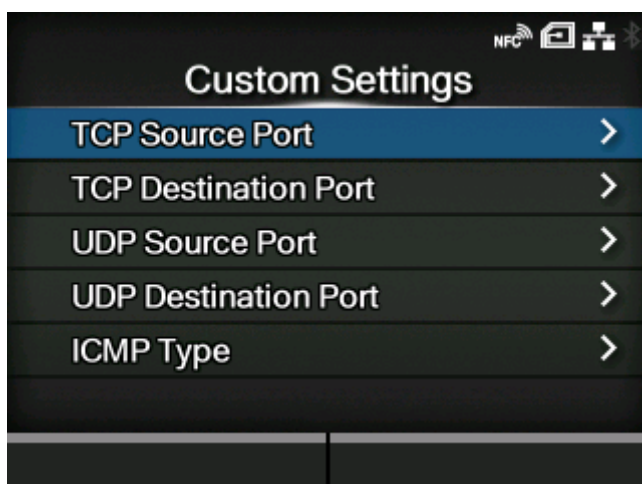

Specify the ICMP type or the port number of TCP or UDP to allow communication.

Available only if you have selected [Enabled] in the [Enable] menu.

The setting items are as follows:

[TCP Source Port](#)

Register the TCP source port number to allow communication.

[TCP Destination Port](#)

Register the TCP destination port number to allow communication.

[UDP Source Port](#)

Register the UDP source port number to allow communication.

[UDP Destination Port](#)

Register the UDP destination port number to allow communication.

[ICMP Type](#)

Register the ICMP type to allow communication.

[TCP Source Port]

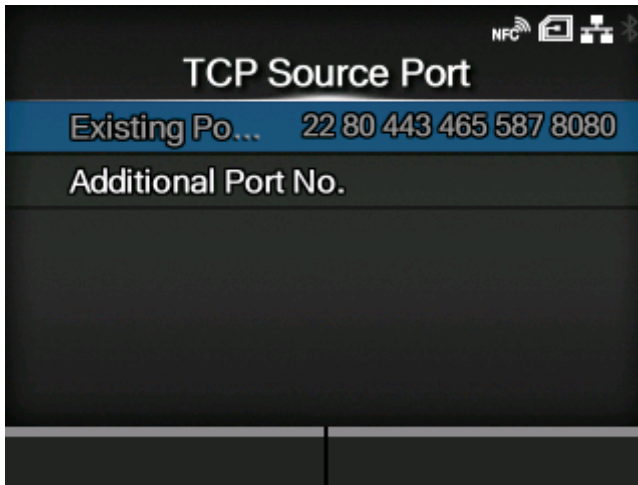

Existing Port No.

The port number of the items enabled in [Allow Services And Ports] are shown.

Additional Port No.

Register the TCP source port number to allow communication.

[Additional Port No.]

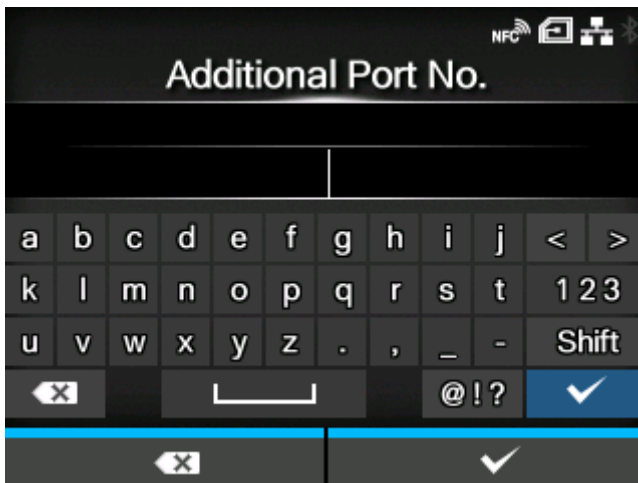

Register the TCP source port number to allow communication.

The acceptable input values are as follows:

Active port number	An integer from 1 to 65535
Specifying multiple values	Delimit active port numbers using a comma “,”
Specifying a range	Create a range of active port numbers using a colon “:” (Input in the order of low port number: high port number)
Maximum number of specifications	21 ports in total by specifying with either numbers or a range

No setting	Blank
------------	-------

Input Example

Port number	Comments
10000	-
10000,10001,10002,10003	This results in the same ports in both settings to be allowed.
10000:10003	
10000,10001,10002,10003,20000	This results in the same ports in both settings to be allowed.
10000:10003,20000	
Blank	Keep it blank when no setting is needed

[TCP Destination Port]

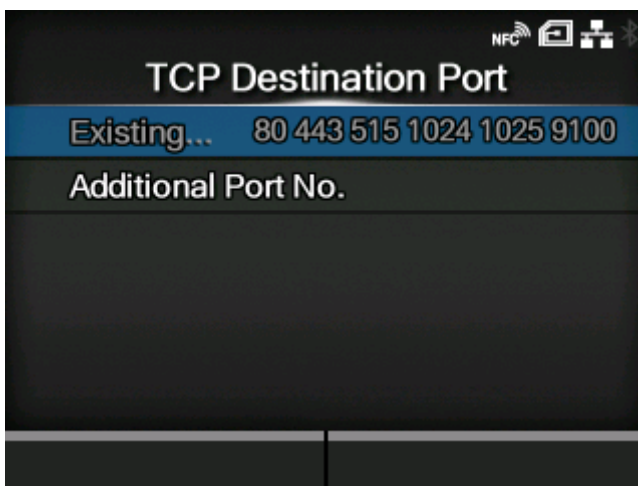

Existing Port No.

The port number of the items enabled in [Allow Services And Ports] are shown.

Additional Port No.

Register the TCP destination port number to allow communication.

[Additional Port No.]

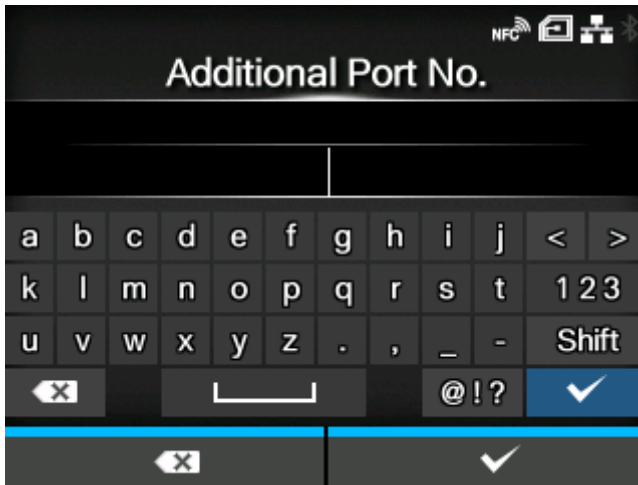

Register the TCP destination port number to allow communication.

The acceptable input values are as follows:

Active port number	An integer from 1 to 65535
Specifying multiple values	Delimit active port numbers using a comma “,”
Specifying a range	Create a range of active port numbers using a colon “:” (Input in the order of low port number: high port number)
Maximum number of specifications	21 ports in total by specifying with either numbers or a range
No setting	Blank

Input Example

Port number	Comments
10000	-
10000,10001,10002,10003	This results in the same ports in both settings to be allowed.
10000:10003	
10000,10001,10002,10003,20000	This results in the same ports in both settings to be allowed.
10000:10003,20000	
Blank	Keep it blank when no setting is needed

[UDP Source Port]

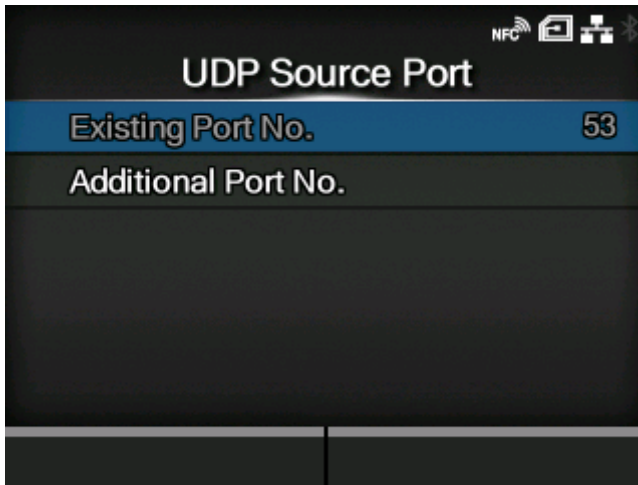

Existing Port No.

The port number of the items enabled in [Allow Services And Ports] are shown.

Additional Port No.

Register the UDP source port number to allow communication.

[Additional Port No.]

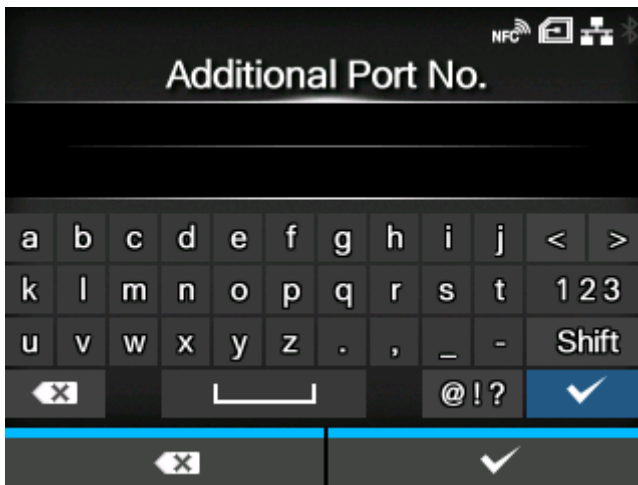

Register the UDP source port number to allow communication.

The acceptable input values are as follows:

Active port number	An integer from 1 to 65535
Specifying multiple values	Delimit active port numbers using a comma “,”
Specifying a range	Create a range of active port numbers using a colon “:” (Input in the order of low port number: high port number)
Maximum number of specifications	21 ports in total by specifying with either numbers or a range

No setting	Blank
------------	-------

Input Example

Port number	Comments
10000	-
10000,10001,10002,10003	This results in the same ports in both settings to be allowed.
10000:10003	
10000,10001,10002,10003,20000	This results in the same ports in both settings to be allowed.
10000:10003,20000	
Blank	Keep it blank when no setting is needed

[UDP Destination Port]

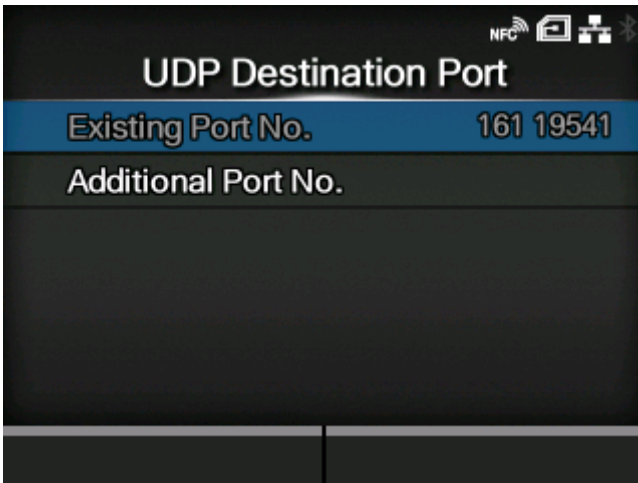

Existing Port No.

The port number of the items enabled in [Allow Services And Ports] are shown.

Additional Port No.

Register the UDP destination port number to allow communication.

[Additional Port No.]

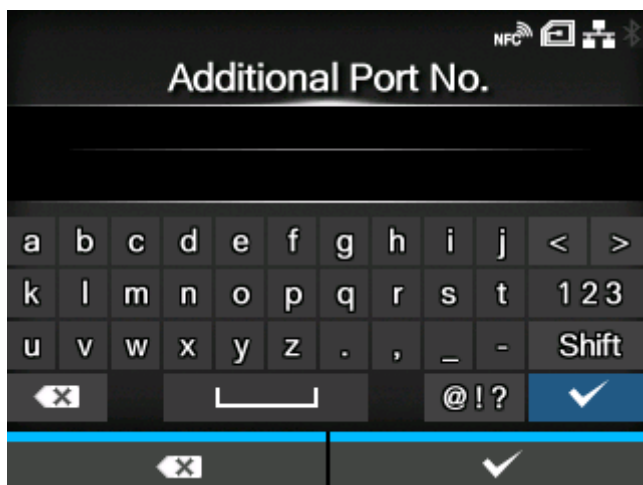

Register the UDP destination port number to allow communication.

The acceptable input values are as follows:

Active port number	An integer from 1 to 65535
Specifying multiple values	Delimit active port numbers using a comma “,”
Specifying a range	Create a range of active port numbers using a colon “:” (Input in the order of low port number: high port number)
Maximum number of specifications	21 ports in total by specifying with either numbers or a range
No setting	Blank

Input Example

Port number	Comments
10000	-
10000,10001,10002,10003	This results in the same ports in both settings to be allowed.
10000:10003	
10000,10001,10002,10003,20000	This results in the same ports in both settings to be allowed.
10000:10003,20000	
Blank	Keep it blank when no setting is needed

[ICMP Type]

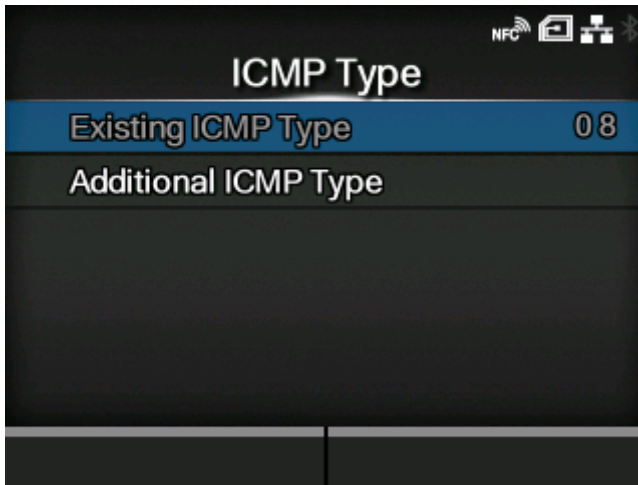

Existing ICMP Type

The ICMP type number of the items enabled in [Allow Services And Ports] are shown.

Additional ICMP Type

Register the ICMP type number to allow communication.

[Additional ICMP Type]

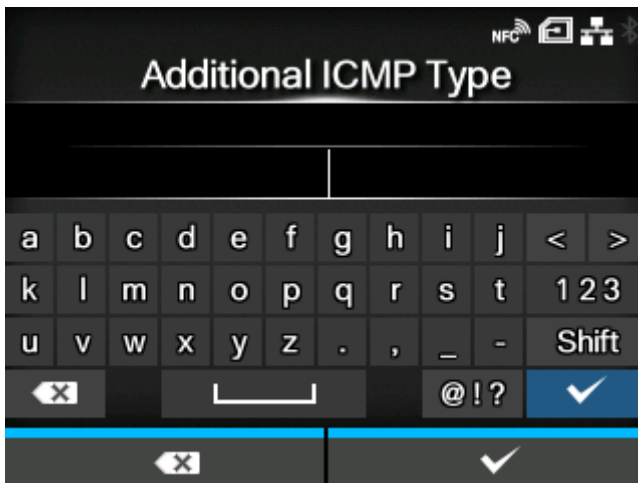

Register the ICMP type number to allow communication.

The acceptable input values are as follows:

Active ICMP type	An integer from 0 to 43
Specifying multiple values	Delimit active ICMP types using a comma “,”
Maximum number of specifications	44 ports
No setting	Blank

Input Example

ICMP type	Comments
0	-
0,1,2,3	-
Blank	Keep it blank when no setting is needed

[IEEE1284]

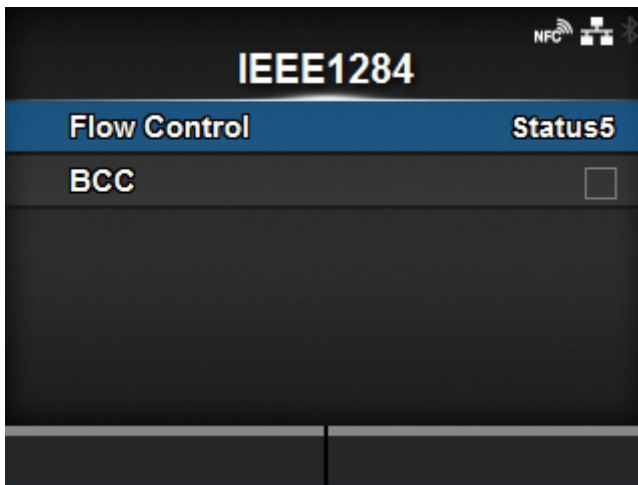

Set the IEEE1284 connection.

Appears only if the combo interface board is installed.

The setting items are as follows:

[Flow Control](#)

Set the communication protocol.

[BCC](#)

Set the BCC check function.

- Appears only if you have selected [Status5] in the [Flow Control] menu.

[Flow Control]

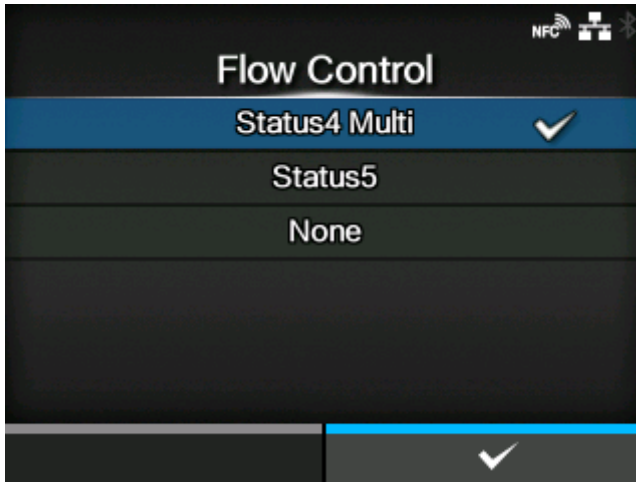

Set the communication protocol.

The options are as follows:

- [Status4 Multi]
- [Status5]
- [None]

[BCC]

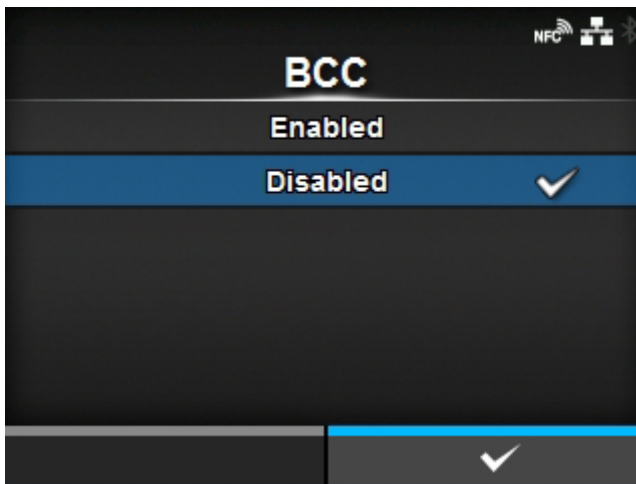

Enable or disable the BCC check function.

Appears only if you have selected [Status5] in the [Flow Control] menu.

The options are as follows:

Enabled

Enable the BCC check function.

Disabled

Disable the BCC check function.

[RS-232C]

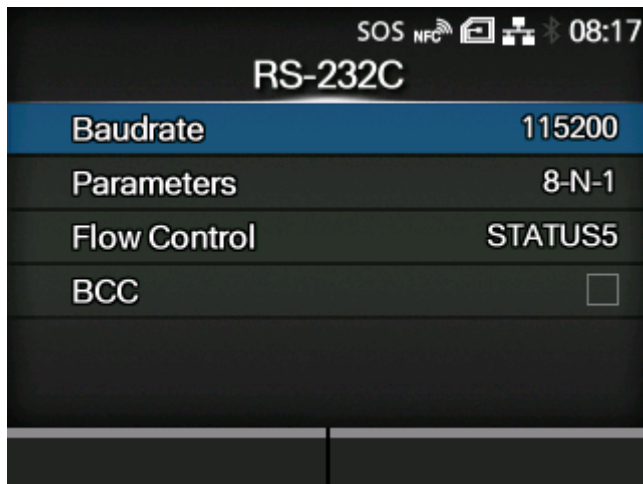

Set the RS-232C connection.

Appears only if the combo interface board is installed.

The setting items are as follows:

[Baudrate](#)

Set the communication speed.

[Parameters](#)

Set the data parameters.

[Flow Control](#)

Set the communication protocol.

[BCC](#)

Set the BCC check function.

- Appears only if you have selected [STATUS5] in the [Flow Control] menu.



- When [Tools] > [Barcode Checker] > [Test] > [Interface] is set to [RS-232C Reader], the following message appears on the screen and you cannot change the [RS-232C] menus.

"Reader is set for RS232C connection destination. Please check the setting of barcode checker."

[Baudrate]

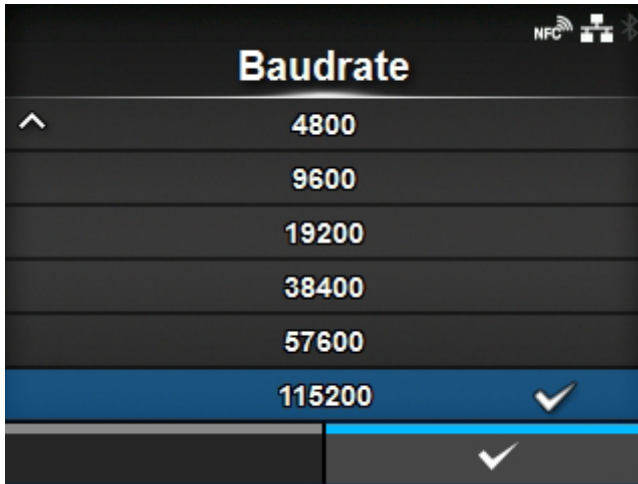

Set the baudrate (bps).

Available to change only if you have selected [RS-232C] in the [Tools] > [Barcode Checker] > [Test] > [Interface] menu.

The options are as follows:

- [2400]
- [4800]
- [9600]
- [19200]
- [38400]
- [57600]
- [115200]

[Parameters]

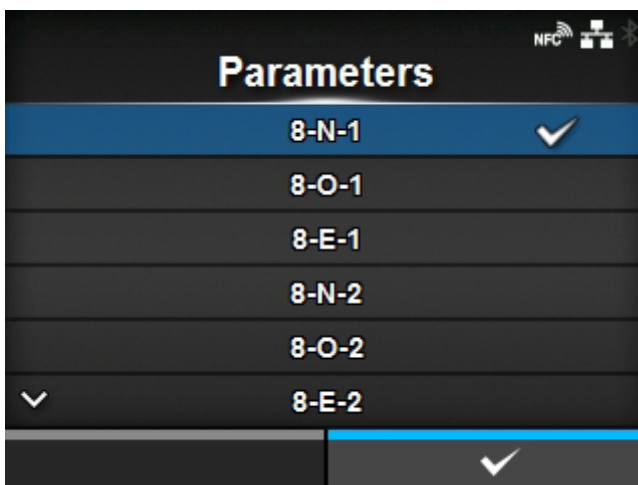

Set the data parameters.

Available to change only if you have selected [RS-232C] in the [Tools] > [Barcode Checker] > [Test] > [Interface] menu.

The options are as follows:

Refer to the table below for the parameter configurations.

- [8-N-1]
- [8-O-1]
- [8-E-1]
- [8-N-2]
- [8-O-2]
- [8-E-2]
- [7-N-1]
- [7-O-1]
- [7-E-1]
- [7-N-2]
- [7-O-2]
- [7-E-2]

Parameter Configurations List

Parameters	Data length (bit)	Parity	Stop bit (bit)
8-N-1	8	NONE	1
8-O-1	8	ODD	1
8-E-1	8	EVEN	1
8-N-2	8	NONE	2
8-O-2	8	ODD	2
8-E-2	8	EVEN	2
7-N-1	7	NONE	1
7-O-1	7	ODD	1
7-E-1	7	EVEN	1
7-N-2	7	NONE	2
7-O-2	7	ODD	2
7-E-2	7	EVEN	2

[Flow Control]

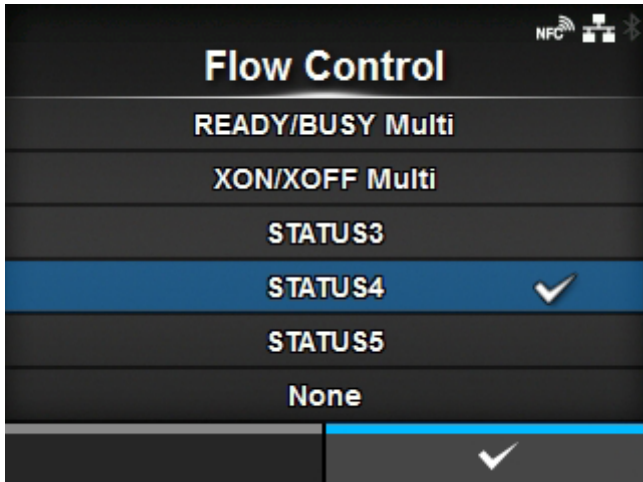

Set the communication protocol.

Available to change only if you have selected [RS-232C] in the [Tools] > [Barcode Checker] > [Test] > [Interface] menu.

The options are as follows:

- [READY/BUSY Multi]
- [XON/XOFF Multi]
- [STATUS3]
- [STATUS4]
- [STATUS5]
- [None]

[BCC]

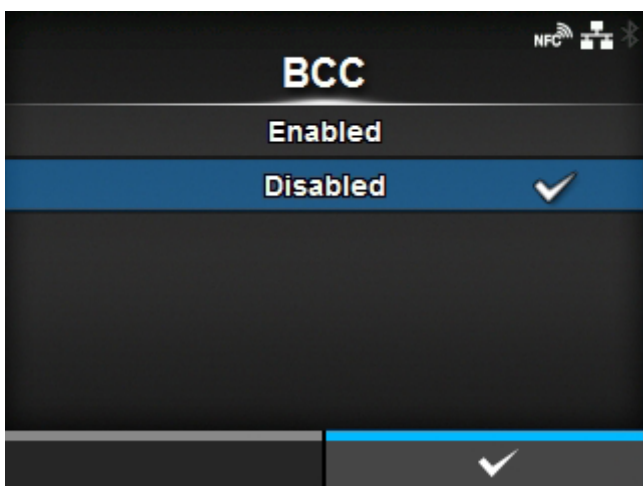

Enable or disable the BCC check function.

Appears only if you have selected [RS-232C] in the [Tools] > [Barcode Checker] > [Test] > [Interface] menu and if you have selected [STATUS5] in the [Flow Control] menu.

The options are as follows:

Enabled

Enable the BCC check function.

Disabled

Disable the BCC check function.

[USB]

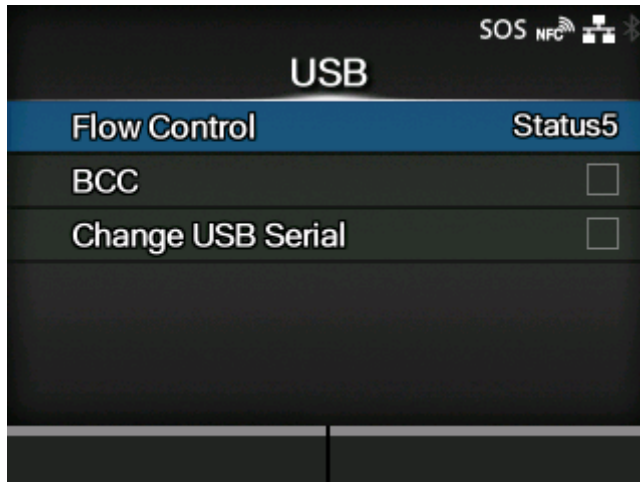

Set the USB connection.

The setting items are as follows:

[Flow Control](#)

Set the communication protocol.

[BCC](#)

Set the BCC check function.

- Appears only if you have selected [Status5] in the [Flow Control] menu.

[Change USB Serial](#)

Set the type of the USB serial number that the product returns.

[Flow Control]

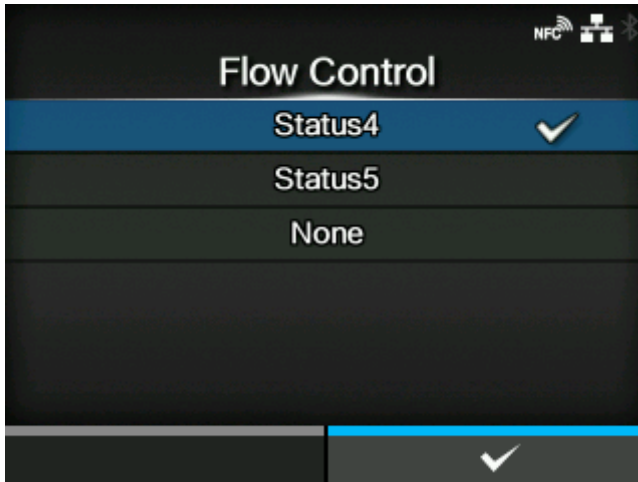

Set the communication protocol.

The options are as follows:

- [Status4]
- [Status5]
- [None]

[BCC]

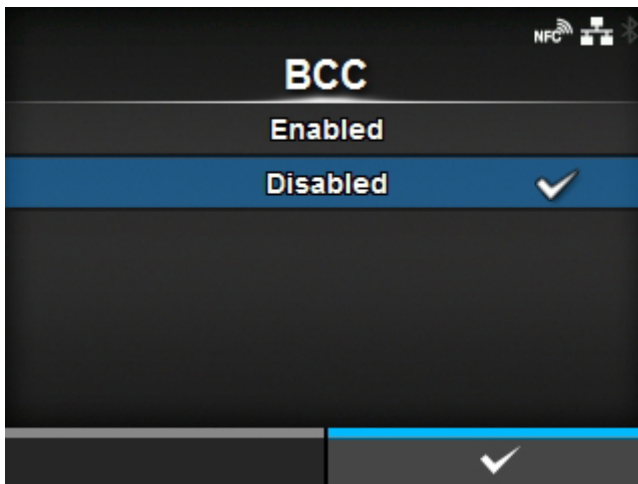

Enable or disable the BCC check function.

Appears only if you have selected [Status5] in the [Flow Control] menu.

The options are as follows:

Enabled

Enable the BCC check function.

Disabled

Disable the BCC check function.

[Change USB Serial]

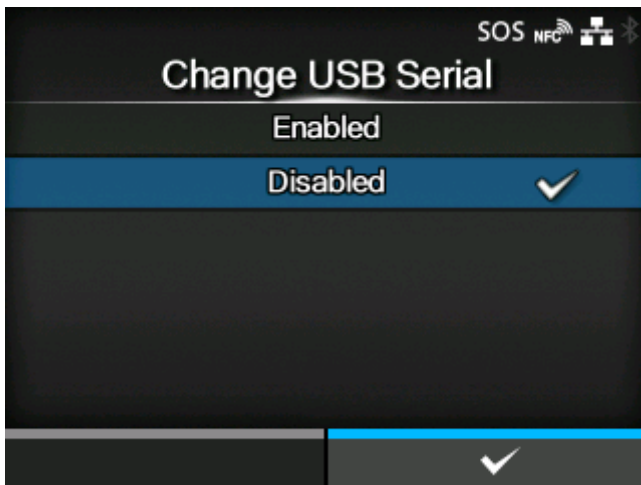

Set the type of the USB serial number that the product returns.

The options are as follows:

Enabled

Returns the USB serial number (00000000).

This option is suitable when you want to replace the product without adding a new printer driver.

To do so, you need to set this setting to enabled before installing the product.

Disabled

Returns the factory set USB serial number (unique to each product).

This option is suitable when you want to set the printer driver for each product.



- If two products that have the same USB serial number connected to the same computer, it may cause the computer to show a blue screen error.
-

[Bluetooth]

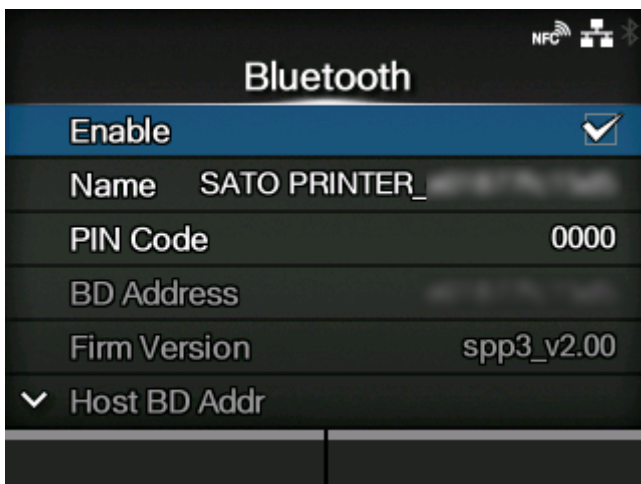

Set the Bluetooth connection.

The setting items are as follows:

[Enable](#)

Enable or disable the functions for Bluetooth.

[Name](#)

Set the device name for the product.

[PIN Code](#)

Set the PIN code.

[BD Address](#)

Shows the BD address of the product. (You cannot change this address.)

[Firm Version](#)

Shows the firmware version of the Bluetooth. (You cannot change this value.)

[Host BD Addr](#)

Check the Host BD address.

[Authentication](#)

Set the authentication level.

[ISI](#)

Set the ISI communication parameter.

[ISW](#)

Set the ISW communication parameter.

[PSI](#)

Set the PSI communication parameter.

[PSW](#)

Set the PSW communication parameter.

[CRC Mode](#)

Set the CRC check function.

[Flow Control](#)

Set the communication protocol.

[Enable]

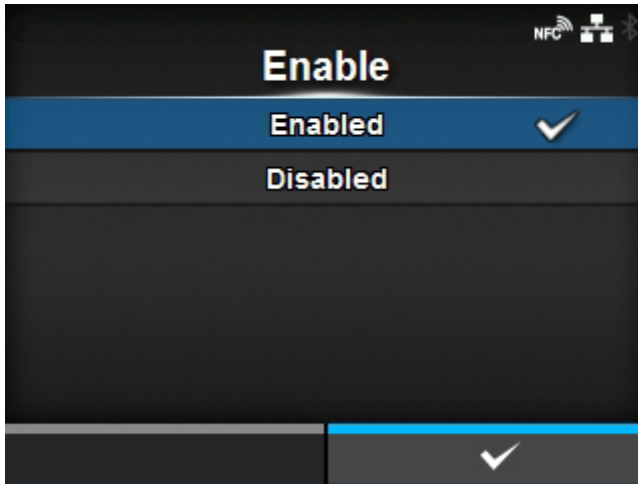

Enable or disable the functions for Bluetooth.

The options are as follows:

Enabled

Enable the Bluetooth function.

Disabled

Disable the Bluetooth function.

[Name]

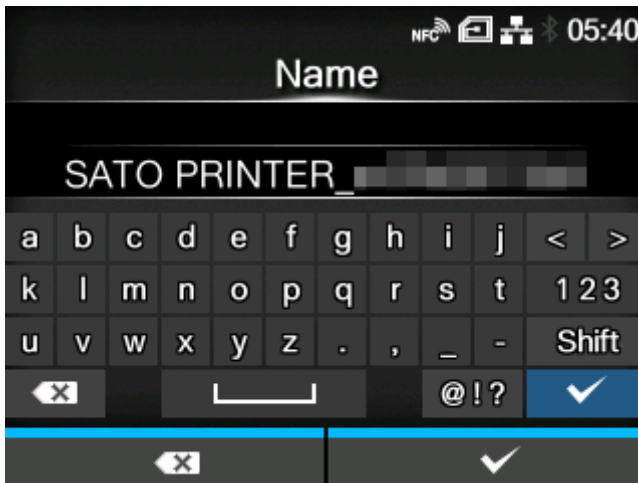

Set the device name for the product.

You can enter 1 to 53 characters. Alphabets (capital and small letters), numbers and symbols can be used.

[PIN Code]

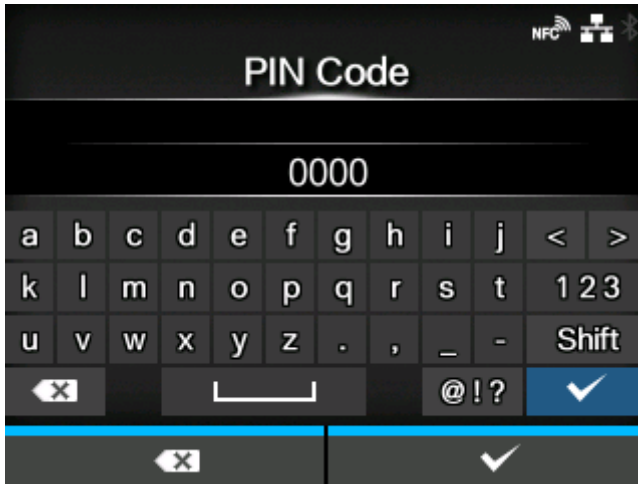

Set the PIN code.

You can enter 4 to 16 characters for the PIN code. Alphabets (capital and small letters), numbers and symbols can be used.

[Authentication]

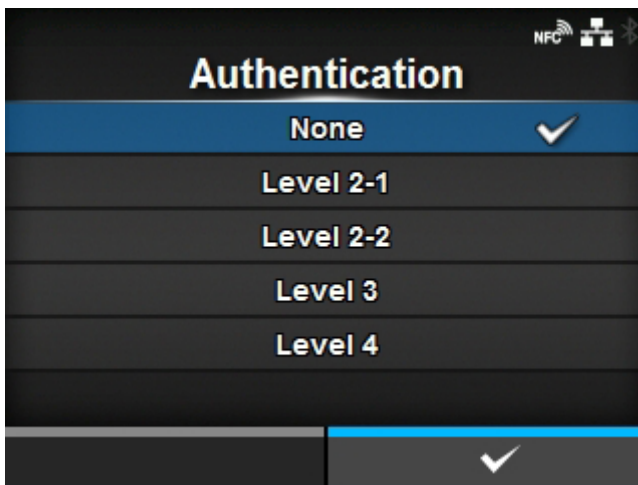

Set the authentication level.

The options are as follows:

None

None

Level 2-1

PIN code authentication, service level, no encryption

Level 2-2

PIN code authentication, service level, encryption

Level 3

PIN code authentication, link level, no encryption

Level 4

Secure Simple Pairing compatible, service level, encryption (Can be communicated with devices that are not compatible with Secure Simple Pairing)

[ISI]

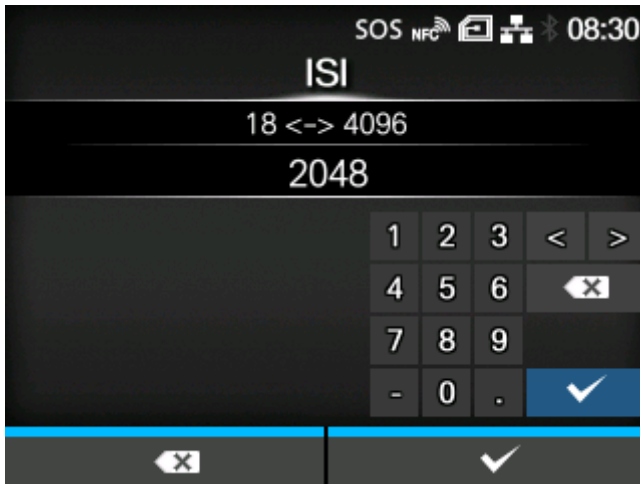

Set the ISI communication parameter.

The setting range is from 18 to 4096.

Set to a value that is higher than the ISW communication parameter setting value.

[ISW]

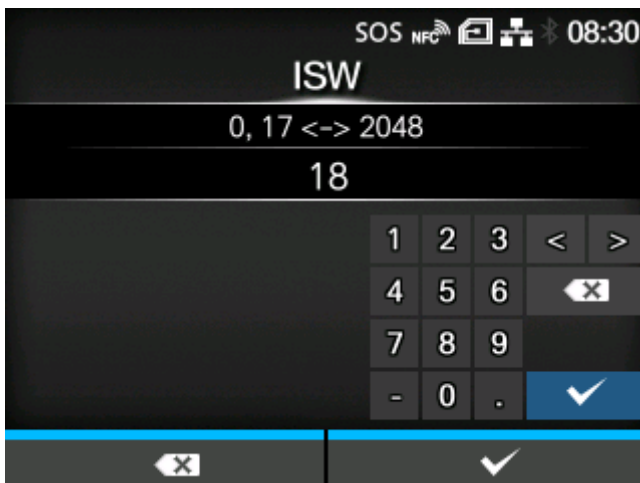

Set the ISW communication parameter.

The setting range is 0, or from 17 to 4096.

The setting range varies depending on the ISI communication parameter setting value.

Set to a value that is less than the ISI communication parameter setting value.

[PSI]



Set the PSI communication parameter.

The setting range is from 18 to 4096.

Set to a value that is higher than the PSW communication parameter setting value.

[PSW]



Set the PSW communication parameter.

The setting range is from 17 to 4096.

The setting range varies depending on the PSI communication parameter setting value.

Set to a value that is less than the PSI communication parameter setting value.

[CRC Mode]

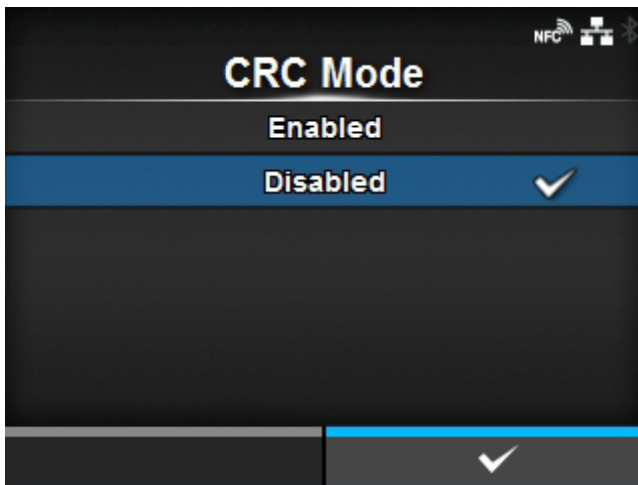

Enable or disable the CRC check function.

The options are as follows:

Enabled

Enable the CRC check function.

Disabled

Disable the CRC check function.

[Flow Control]

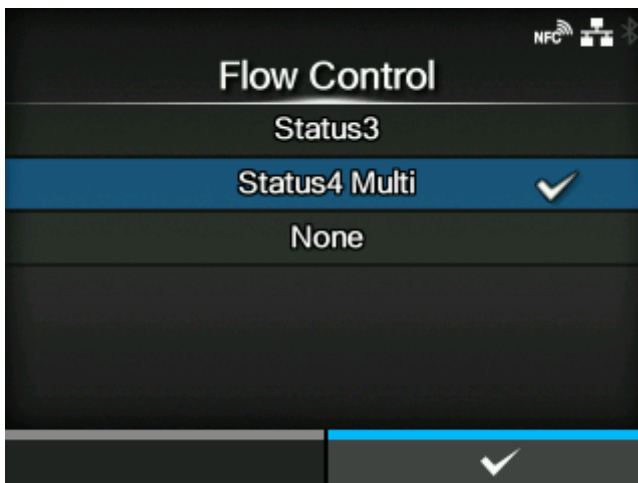

Set the communication protocol.

The options are as follows:

- [Status3]
- [Status4 Multi]
- [None]

[NFC]

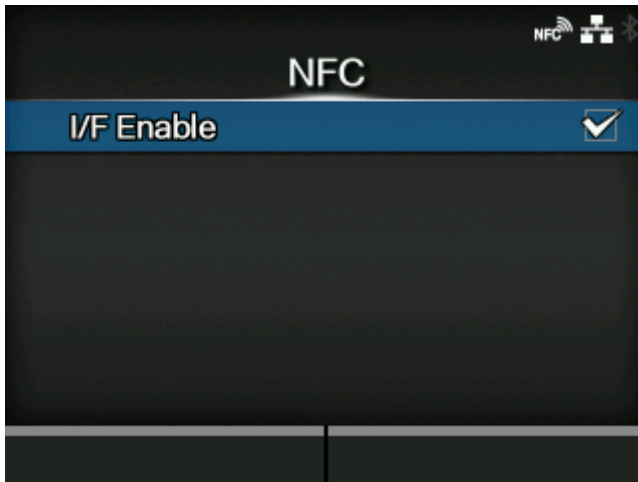

Sets the NFC connection.

The setting item is as follows:

I/F Enable

Enables or disables the NFC interface.

[I/F Enable]

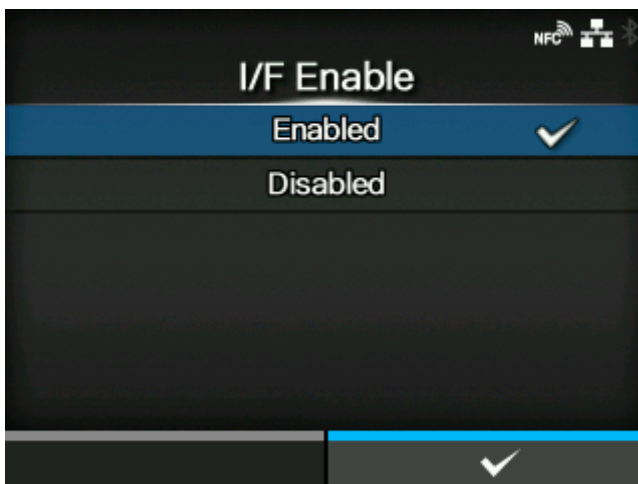

Enables or disables the NFC interface.

The options are as follows:

Enabled

Enables the NFC interface.

Disabled

Disables the NFC interface.

[Ignore CR/LF]

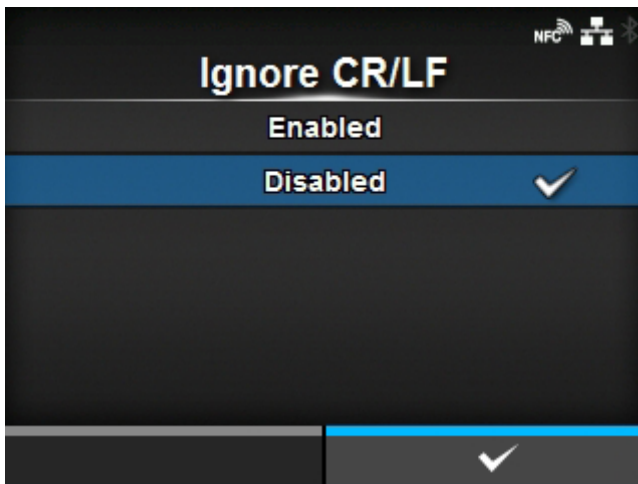

Set whether to ignore the CR/LF code (0x0D / 0x0A) in the received data.

The options are as follows:

Enabled

Ignore the CR/LF code.

Disabled

Do not ignore the CR/LF code.

[Ignore CAN/DLE]

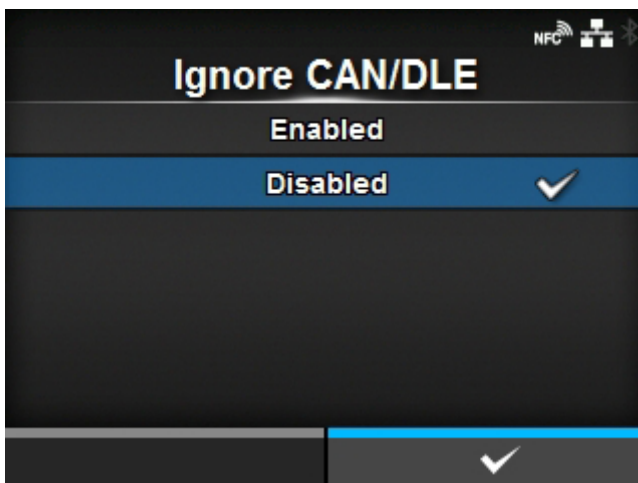

Set whether to ignore the CAN/DLE code (0x18 / 0x10) in the received data.

The options are as follows:

Enabled

Ignore the CAN/DLE code.

Disabled

Do not ignore the CAN/DLE code.

[External I/O]

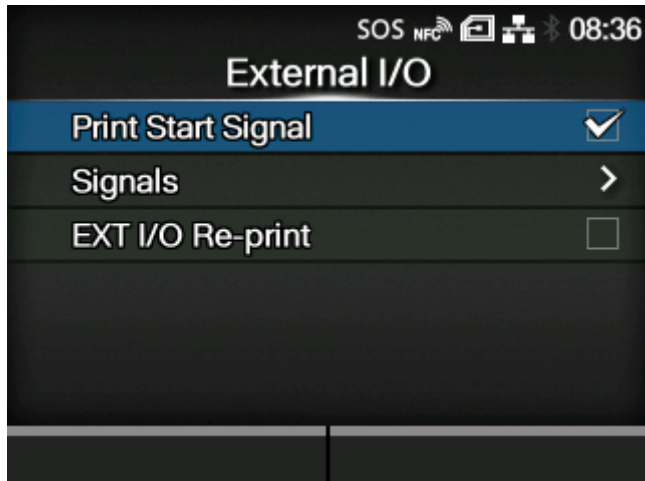

Use the external (EXT) terminal as an interface between the external device and the product.

Appears if the combo interface board is installed.

The setting items are as follows:

[Print Start Signal](#)

Enable or disable the Print Start signal.

[Signals](#)

Set the input/output signals.

- Appears if you have selected [Enabled] in the [Print Start Signal] menu.

[EXT I/O Re-print](#)

Set the reprint function that uses the external terminal.

[Print Start Signal]

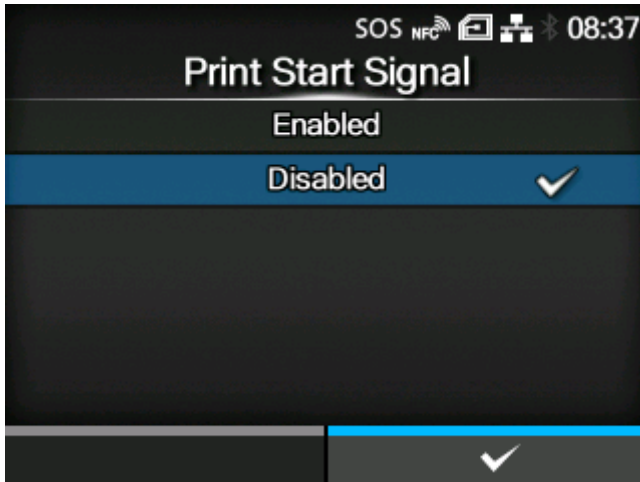

Enable or disable the Print Start signal.

The options are as follows:

Enabled

Enable the Print Start signal.

Disabled

Disable the Print Start signal.

[Signals]

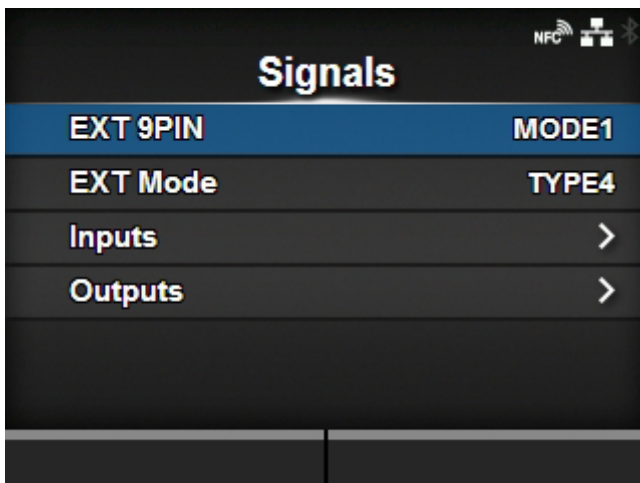

Set the input/output signals.

Appears only if you have selected [Enabled] in the [Print Start Signal] menu.

The setting items are as follows:

[EXT 9PIN](#)

Set the function of the EXT 9PIN output.

[EXT Mode](#)

Set the mode of the Print End signal.

[Inputs](#)

Assign the pin No. to the input signals Print Start and Reprint.

[Outputs](#)

Assign the pin No. to output signals.

[EXT 9PIN]

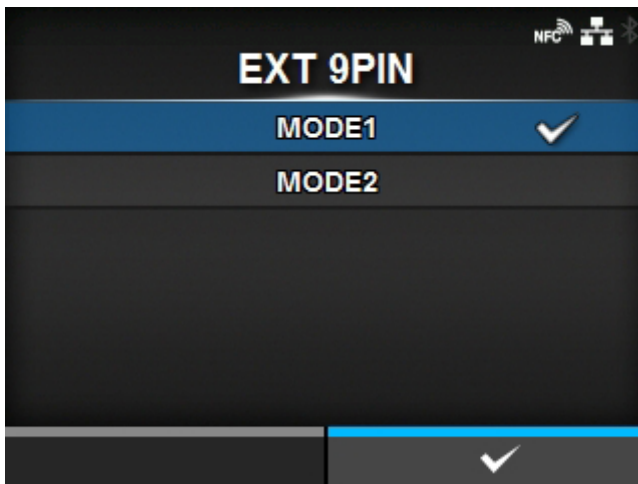

Set the function of the EXT 9PIN output.

The options are as follows:

MODE1

The output signal becomes "Active" only when there is data in print buffer and product is ONLINE.

MODE2

The output signal becomes "Active" when product is ONLINE.

[EXT Mode]

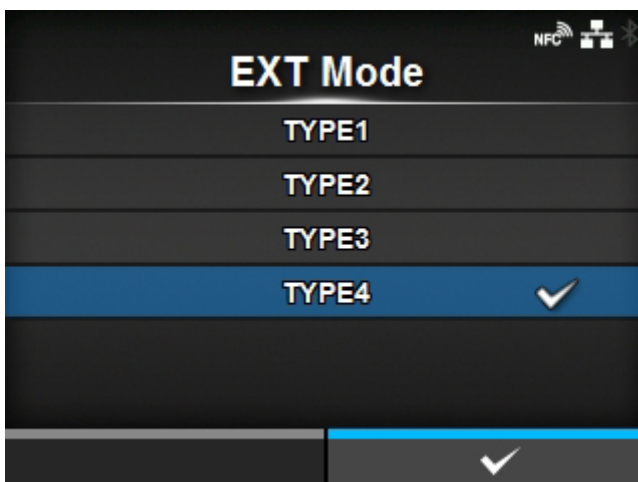

Set the mode of the Print End signal.

The options are as follows:

TYPE1

20 ms "LOW" pulse will be provided after the completion of print and dispense for the Print End signal (PREND).

TYPE2

20 ms "HIGH" pulse will be provided after the completion of print and dispense for the Print End signal (PREND).

TYPE3

The Print End signal (PREND) will be "LOW" during label printing and feed forwarding.

TYPE4

The Print End signal (PREND) will be "HIGH" during label printing and feed forwarding.



• For details, refer to the Timing Charts.

[Inputs]

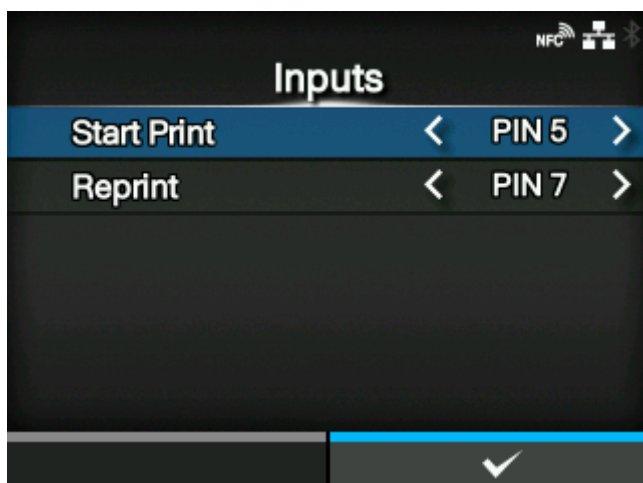

Assign the pin No. to the input signals Print Start and Reprint.

Press the ▲ / ▼ buttons to highlight the item that you want to change, and press the ◀ / ▶ buttons to change the pin No.

Press the ↩ button to save the settings and return to the [Signals] menu.

The setting items are as follows:

Start Print

Assign the pin No. for the Print Start signal input.

The options are as follows:

[PIN 5]	Assign Pin 5 to the Print Start signal.
[PIN 7]	Assign Pin 7 to the Print Start signal.

Reprint

Assign the pin No. for the Reprint signal input.

The options are as follows:

[PIN 5]	Assign Pin 5 to the Reprint signal.
[PIN 7]	Assign Pin 7 to the Reprint signal.



- You cannot set any inputs using the same pin number. If you attempt to set the same number, the settings will be shown in red and you cannot save the settings.

[Outputs]



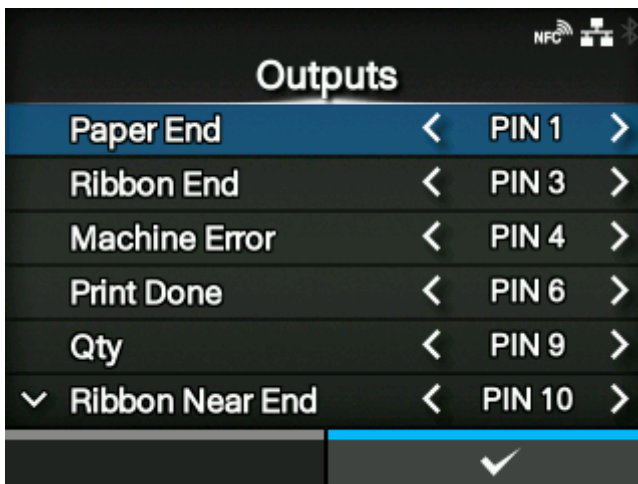

For non-RFID models

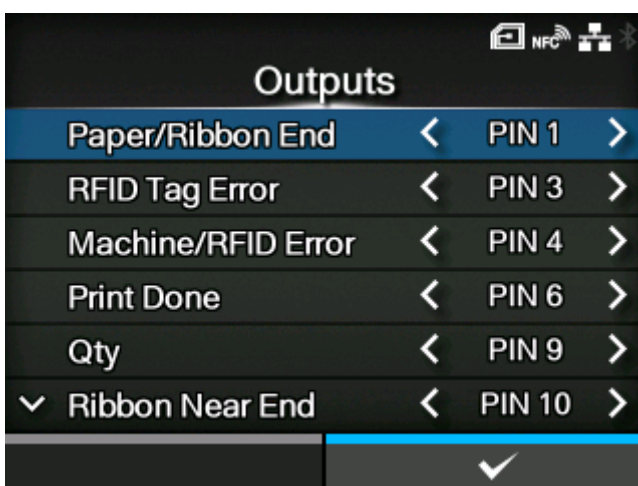

For RFID models



Assign the pin No. to output signals.

Press the  /  buttons to highlight the item that you want to change, and press the  /  buttons to change the pin No.

Press the  button to save the settings and return to the [Signals] menu.

The setting items are as follows:

Paper End

Paper/Ribbon End (For RFID models)

Assign the pin No. for the Paper End signal output.

Assign the pin No. for the Paper/Ribbon End signal output if you have installed the RFID.

Ribbon End

RFID Tag Error (For RFID models)

Assign the pin No. for the Ribbon End signal output.

Assign the pin No. for the RFID Tag Error signal output if you have installed the RFID.

Machine Error

Machine/RFID Error (For RFID models)

Assign the pin No. for the Machine Error signal output.

Assign the pin No. for the Machine/RFID Error signal output if you have installed the RFID.

Print Done

Assign the pin No. for the Print Done signal output.

Qty

Offline

[Qty] is shown if [MODE1] is selected in the [EXT 9PIN] menu.

[Offline] is shown if [MODE2] is selected in the [EXT 9PIN] menu.

Assign the pin No. for the Qty/Offline signal output.

Ribbon Near End

Assign the pin No. for the Ribbon Near End signal output.

Dispenser

Assign the pin No. for the Dispenser signal output.

- Use this signal to connect the dispenser unit or linerless cutter kit (CL4NX Plus only).

Label Near End

Assign the pin No. for the Label Near End signal output.

The options for each signal output are as follows:

[PIN 1]	Set the selected signal to pin 1.
[PIN 3]	Set the selected signal to pin 3.
[PIN 4]	Set the selected signal to pin 4.
[PIN 6]	Set the selected signal to pin 6.
[PIN 9]	Set the selected signal to pin 9.
[PIN 10]	Set the selected signal to pin 10.

[OFF]	Set the selected signal to off mode.
-------	--------------------------------------



- You cannot set any outputs using the same pin number. If you attempt to set the same number, the settings will be shown in red and you cannot save the settings.

[EXT I/O Re-print]

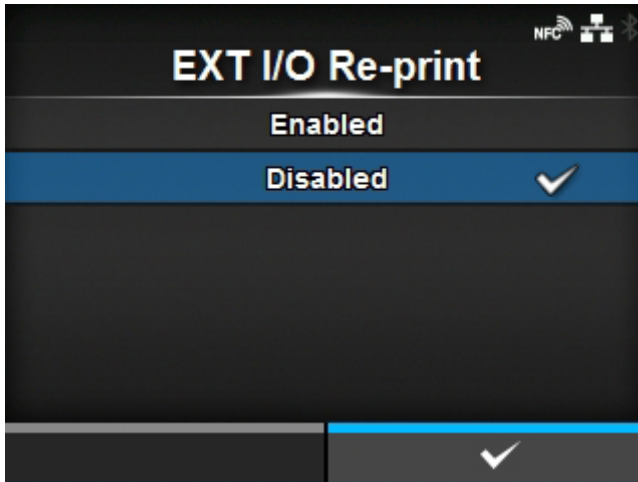

Set the reprint function that uses the external terminal.

The options are as follows:

Enabled

Enable the reprint function.

Disabled

Disable the reprint function.

[RFID] (RFID Models Only)

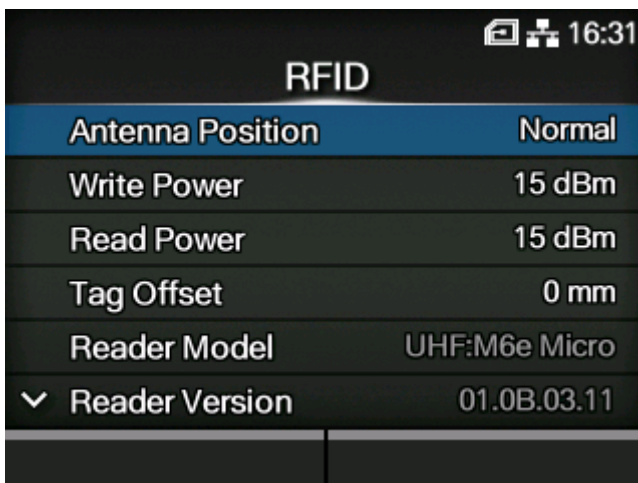

Set the RFID.

Appears only for the RFID model.

The setting items are as follows:

[Antenna Position](#)

Set an RFID antenna to use.

[Write Power](#)

Set radio power level used to write information to inlay.

[Read Power](#)

Set radio power level used to read information from inlay.

[Tag Offset](#)

Set distance to print on label BEFORE pausing to encode RFID.

[Reader Model](#)

Shows the RFID module model.

[Reader Version](#)

Shows the RFID module firmware version.

[PLD Version](#)

Shows the RFID module PLD version.

[View](#)

Shows the inlay data.

[Filter Function](#)

Set the RSSI filter function.

[Retry Mode](#)

Set whether to retry encoding of failed data when an RFID error occurs.

[Retries](#)

Set the number of times the retry/release operations as set in [Retry Mode] are repeated before printing stops and the RFID error screen opens, when an RFID error occurs.

[Mark bad tags](#)

Set the error print for the RFID tag error.

[RFID Undetected Warning](#)

Set a warning message that occurs when the RFID commands are undetected.

[Log RFID Data](#)

Set the log function to record the encoded tag information.

[Data To Record](#)

Set the data to be recorded.

[Output Error Mode](#)

Set the signal type for RFID errors.

[Pulse Length](#)

Set the length of an RFID error pulse.

- Appears only if you have selected [Pulse] in the [Output Error Mode] menu.

Counters

Shows the RFID counter.

Paper

Set the paper type of RFID tags and the print reference position in the vertical direction.

SATO RF Analyze

Set and execute the SATO RF Analyze function, and save the results of the measurements.

RFID Tag Model

Register, edit, read, and delete RFID tag models.

[Antenna Position]  

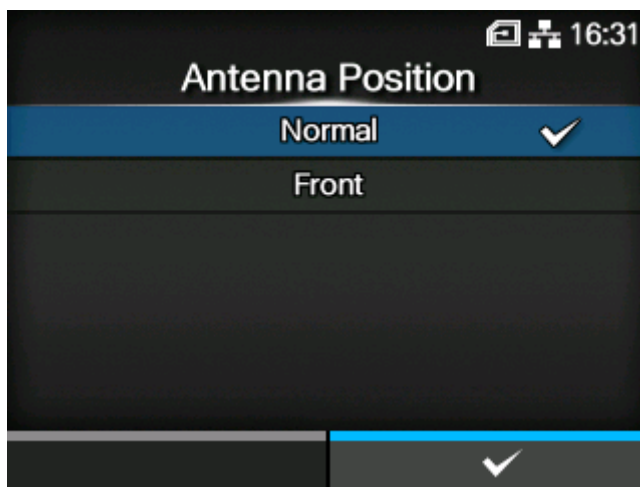

Follow the Inlay Configuration Guide to select an RFID antenna to use. For details, access the following URL:

<https://www.sato-global.com/rfid/guide.html>

To use inlays that are not in the Inlay Configuration Guide, contact your SATO sales representative or reseller.

If the installed module is UHF

The options are as follows:

Normal

Use a standard antenna (adjustable).

With the SATO RF Analyze function, you can automatically adjust the position of the standard antenna to suit the RFID tag you are using. You can record the results of the automatic adjustment in [RFID Tag Model]. Or, you can manually adjust the position of the standard antenna with [RFID Tag Model].

Front

Use a short pitch antenna (fixed position).

If the installed module is HF

Use a standard antenna. Specify the position on the standard antenna in the vertical direction.

The options are as follows:

- [Forward]
- [Center]
- [Backward]

[Write Power] UHF HF

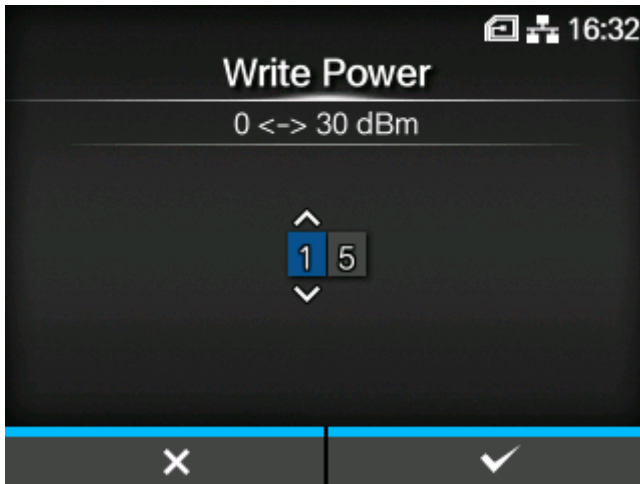

Set radio power level used to write information to inlay according to the Inlay Configuration Guide. For details, access the following URL:

<https://www.sato-global.com/rfid/guide.html>

To use inlays that are not in the Inlay Configuration Guide, contact your SATO sales representative or reseller.

Appears only if the module is UHF.

The setting range is from 0 to 30 dBm.

The setting range differs depending on where the product is being operated.



- The changes to this setting are linked and are changed with the settings in the [SATO RF Analyze] > [Write Power] menu.

[Read Power] UHF HF

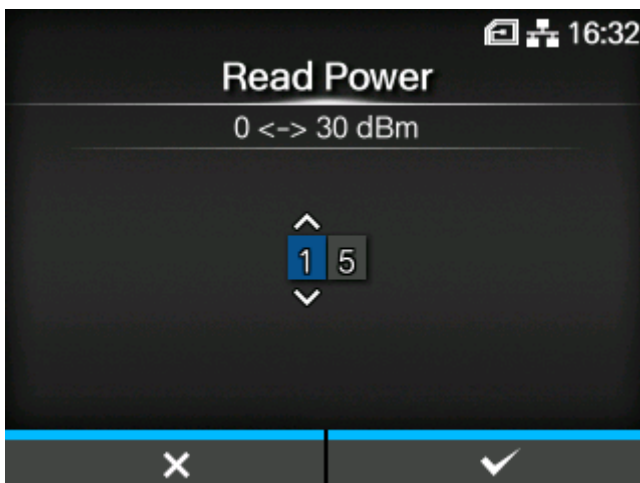

Set radio power level used to read information from inlay according to the Inlay Configuration Guide. For details, access the following URL:

<https://www.sato-global.com/rfid/guide.html>

To use inlays that are not in the Inlay Configuration Guide, contact your SATO sales representative or reseller.

Appears only if the module is UHF.

The setting range is from 0 to 30 dBm.

The setting range differs depending on where the product is being operated.



- The changes to this setting are linked and are changed with the settings in the [SATO RF Analyze] > [Read Power] menu.

[Tag Offset] UHF HF



Set the position at which to start writing data to the inlay. Data is written to an inlay on each tag at the point where the inlay passes over the product's RFID antenna, which is at the distance, from the print start position, specified in this setting.

This setting will be used when inlays are not compatible with the product's antenna positions. For details, access the following URL:

<https://www.sato-global.com/rfid/guide.html>

To use inlays that are not in the Inlay Configuration Guide, contact your SATO sales representative or reseller.

The setting range is from -15 to 240 mm (-0.59 to 9.45").

The minimum value is 0 mm (0") if other than [Continuous] is selected in the [Printing] > [Print Mode] menu.

[View] UHF HF

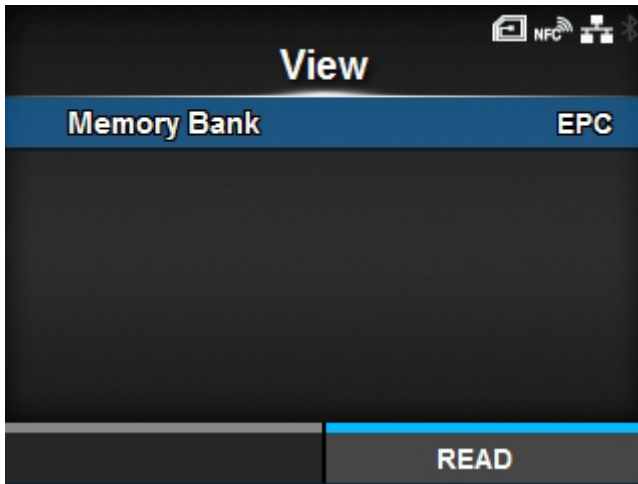

Shows the inlay data.

Press the  button to change to the [Memory Bank] screen.

Press the  button (READ) to change to the [Data Reading] screen, to read and show the data.

On the [Data Reading] screen, you can press the  button to feed the media and attempt to read the tag currently set in the product.

When no inlay has been detected, "Tag not found" appears on the screen. When multiple inlays have been detected at the same time, "Multiple tags error" appears on the screen.

[Memory Bank] UHF HF

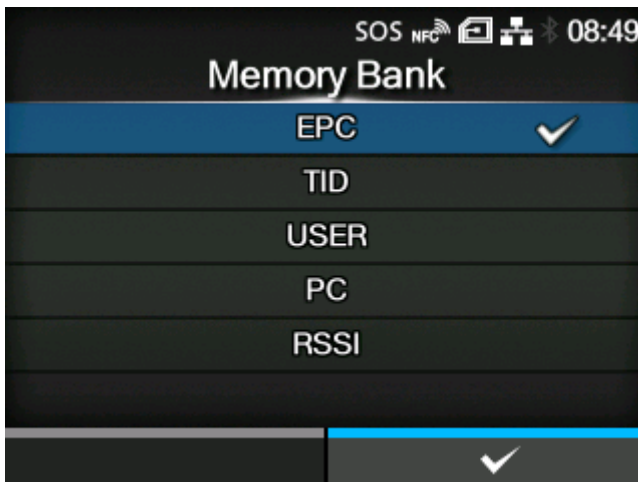

Set the memory area of the inlay to read.

The readable memory areas are as follows:

If the installed module is UHF

EPC

EPC area

TID

TID area

USER

USER area

PC

PC/AFI area

RSSI

RSSI area

If the installed module is HF

USER

USER area

UID

UID area

[Filter Function] **UHF** **HF**

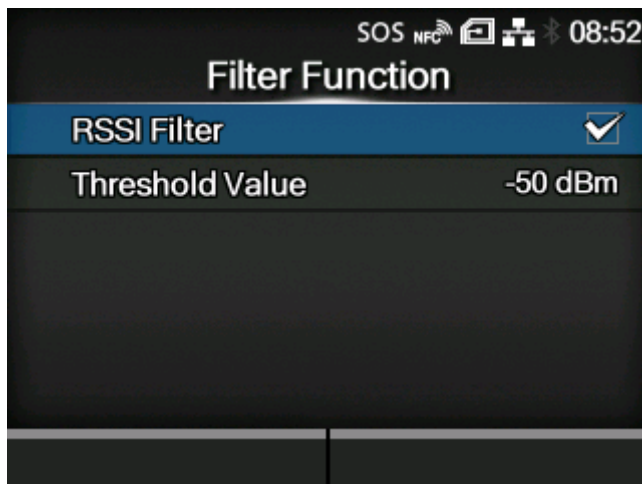

Set the filter function by RSSI (Received Signal Strength Indication). If the RSSI value read while printing an RFID tag is lower than the specified threshold value, an RFID tag error occurs. An error message is printed on the inlay/RFID tag that caused the error.

Appears only if the installed module is UHF.

The setting items are as follows:

RSSI Filter

Enable or disable the RSSI filter function.

Threshold Value

Set the threshold value for the RSSI filter.

- Appears only if [Enabled] is selected in the [RSSI Filter] menu.

[RSSI Filter] U_{HF} H_F

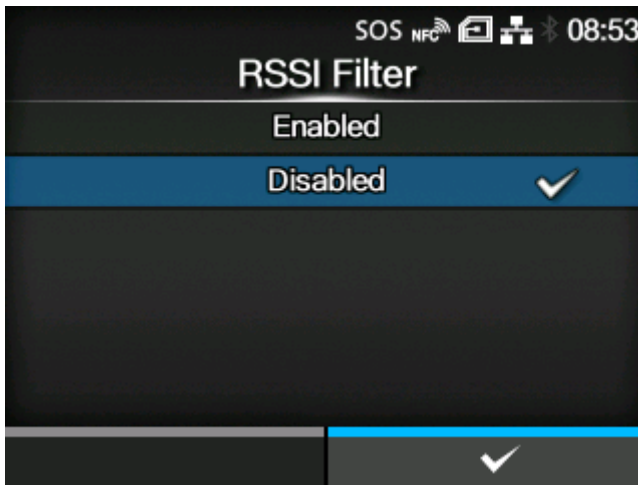

Enable or disable the RSSI filter function.

The options are as follows:

Enabled

Enable the RSSI filter function.

Disabled

Disable the RSSI filter function.

[Threshold Value] U_{HF} H_F

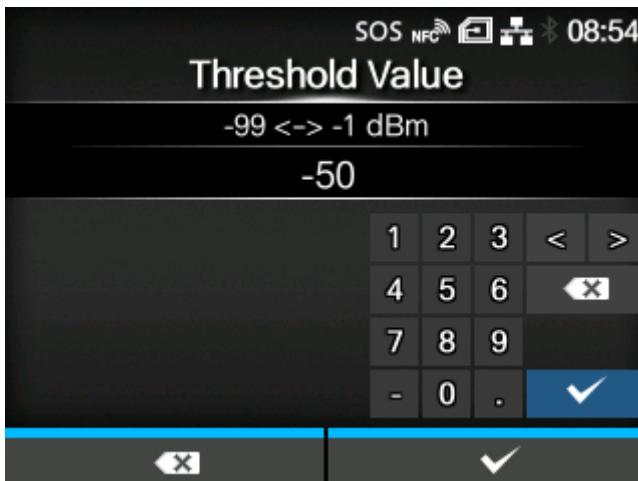

Set the threshold value for the RSSI filter.

Appears only if [Enabled] is selected in the [RSSI Filter] menu.

The setting range is from -99 to -1 dBm.

[Retry Mode] UHF HF

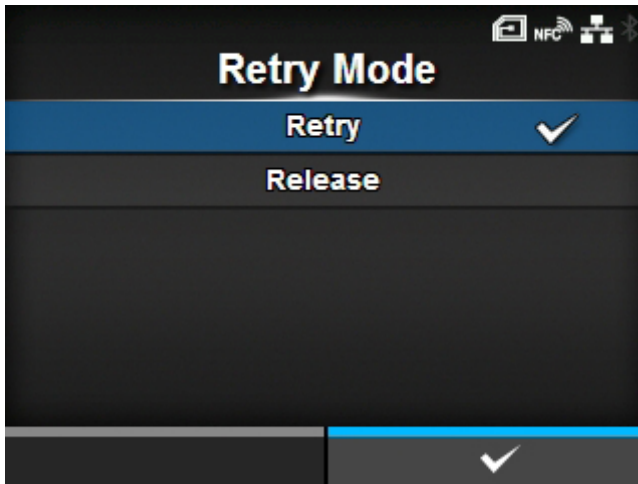

Set whether to retry encoding of failed data when an RFID error occurs.

The options are as follows:

Retry

If an RFID error occurs, the product will retry writing according to the number of times of [Retries]. If the RFID errors occur consecutively, printing stops after the number of retries in [Retries] plus one more retry occur, and the RFID error screen opens.

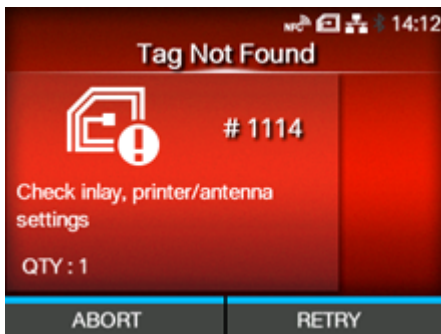

Pressing the  button (RETRY) retries writing the number of times in [Retries].

Pressing the  button (ABORT) deletes one current item.

Release

If an RFID error occurs, the next data is written, without trying to write the same data again. If the RFID errors occur consecutively, printing stops after the number of retries in [Retries] occurs, and the RFID error screen opens.

Pressing the  button (RETRY) deletes one copy of the current print data, and then starts printing the next.

Example:

- If one copy each of 10 items are being printed, the current item is deleted, and the remaining items are printed.
- If 10 copies of one item are being printed, the current print data is deleted, and the remaining copies are printed.

Pressing the  button (ABORT) deletes the one current item, and then starts printing the next.

Example:

- If one copy each of 10 items are being printed, the current item is deleted, and the remaining items are printed.
- If 10 copies of one item are being printed, the current item is deleted, and then printing stops.

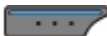

- To cancel an entire print job, open and close the top cover to switch the product to Offline mode, and then press the  button (CANCEL).

[Retries]  

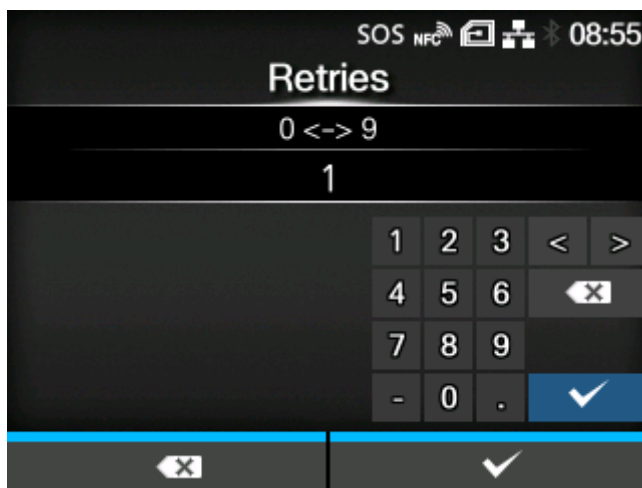

Set the number of times the retry/release operations as set in [Retry Mode] are repeated before printing stops and the RFID error screen opens, when an RFID error occurs.

The setting range is from 0 to 9.

If you set to 0, the RFID error screen appears and printing continues.

[Mark bad tags]  

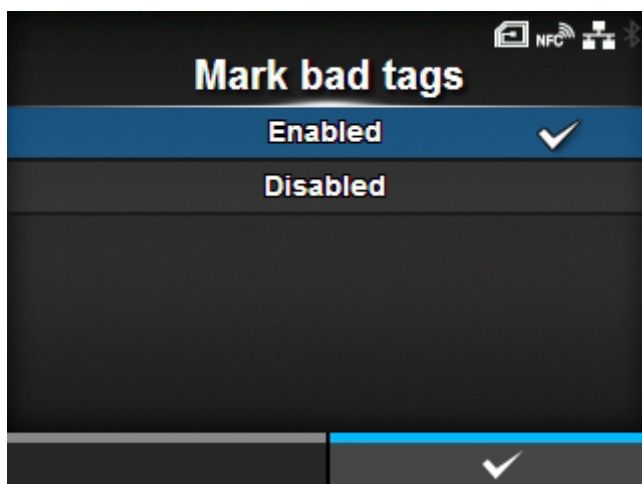

Set the error print for the RFID tag error.

Enabled

Enable the RFID error print function.

Disabled

Disable the RFID error print function.

[RFID Undetected Warning]  

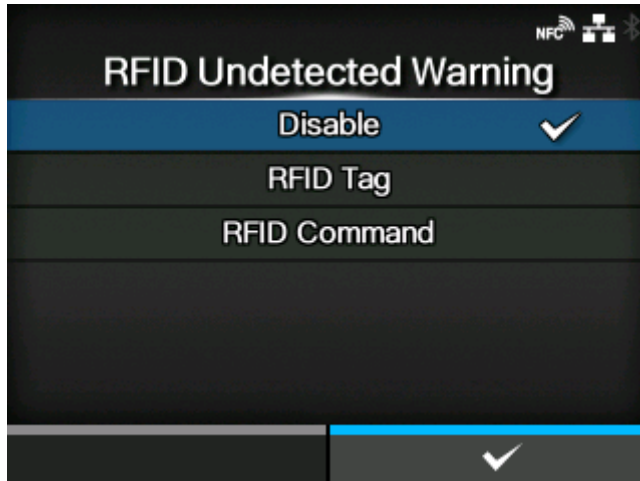

To prevent wasting RFID tags, set whether to stop printing and display an RFID undetected warning error if there is no RFID command in the print job.

The RFID commands that are detected by this function are EPC code write <IP0>, RFID write <RK>, and UID/EPC/IDm print <TU> commands.

The options are as follows:

Disable

The RFID undetected warning error is not displayed. Printing continues.

RFID Tag

Printing stops and an RFID undetected warning error is displayed if there is no RFID command in the print job when an RFID tag is loaded.

The error is no longer displayed if the media is replaced with normal labels.

RFID Command

Printing stops and an RFID undetected warning error is displayed if there is no RFID command in the print job.



- An RFID undetected warning is displayed even when using an RFID command that is intended to be detected in the print job, if it is written in the data that caused the command error.
-

[Log RFID Data] UHF HF

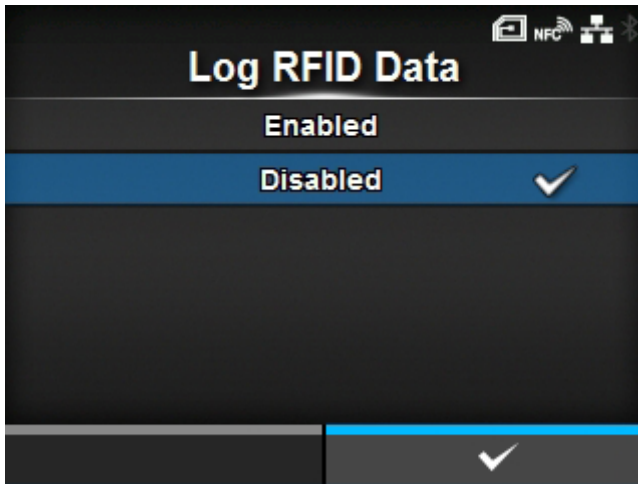

Set the log function to record the encoded tag information.

The log data can record up to 100 inlays of information. When the log file reaches its maximum size, the new log data overwrites the older log data.

All the log data will be lost if the product is powered off.

The options are as follows:

Enabled

Enable the log function to record the RFID data.

Disabled

Disable the log function to record the RFID data.



- UID data is recorded if the module is HF.
-

[Data To Record] UHF HF

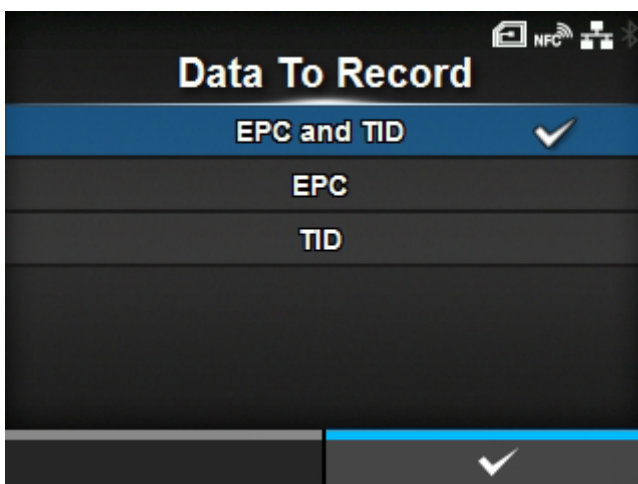

Set the data to record the log when [Log RFID Data] is enabled.

Appears only if the module is UHF.

The options are as follows:

EPC and TID

Store the EPC and TID data.

EPC

Store the EPC data.

TID

Store the TID data.

[Output Error Mode] **UHF** **HF**

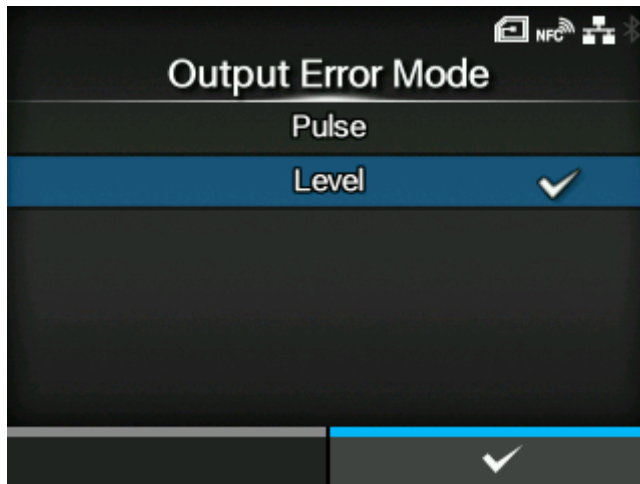

Set the signal type for RFID errors.

The options are as follows:

Pulse

Outputs a pulse as the output signal when an RFID error occurs.

Level

Outputs a level as the output signal when an RFID error occurs.

[Pulse Length] UHF HF

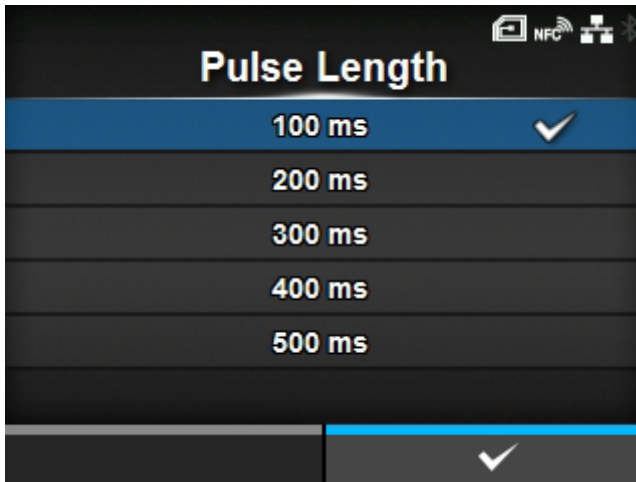

Set the length of an RFID error pulse.

Appears only if you have selected [Pulse] in the [Output Error Mode] menu.

The options are as follows:

- [100 ms]
- [200 ms]
- [300 ms]
- [400 ms]
- [500 ms]

[Counters] UHF HF

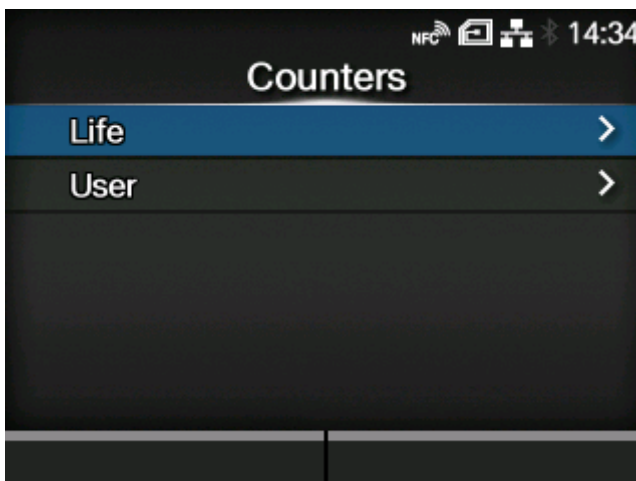

Shows the RFID counter.

RFID writing operations by the following commands are counted.

- RFID write: EPC code write <IP0> command, RFID write <RK> command
- Tag data print: UID/EPC/IDm print <TU> command

However, writing that is not accompanied by printing and media feeding is not counted.

The display items are as follows:

[Life](#)

Shows the number of RFID write successes, failures, and total attempts.

[User](#)

Shows the number of RFID write successes, failures, and total attempts after the RFID counter is cleared.

[Life] **U** **H**

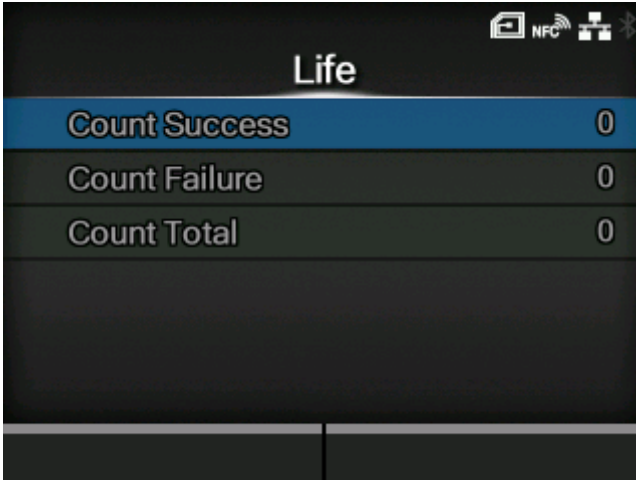

The screenshot shows a mobile application interface titled "Life". At the top right, there are icons for NFC, Wi-Fi, and signal strength. The main content area displays three rows of statistics, each with a label on the left and a numerical value on the right. The first row, "Count Success", is highlighted in blue and shows a value of 0. The second row, "Count Failure", shows a value of 0. The third row, "Count Total", shows a value of 0. Below these rows is a dark grey bar.

Category	Count
Count Success	0
Count Failure	0
Count Total	0

Shows the number of RFID write successes, failures, and total attempts.

The display items are as follows:

Count Success

Shows the total number of successful times you have written to an RFID tag.

Count Failure

Shows the total number of RFID write errors.

Count Total

Shows the total number of times you have written to an RFID tag.

This is the total number including [Count Success] and [Count Failure].

[User] U_{HF} H_F

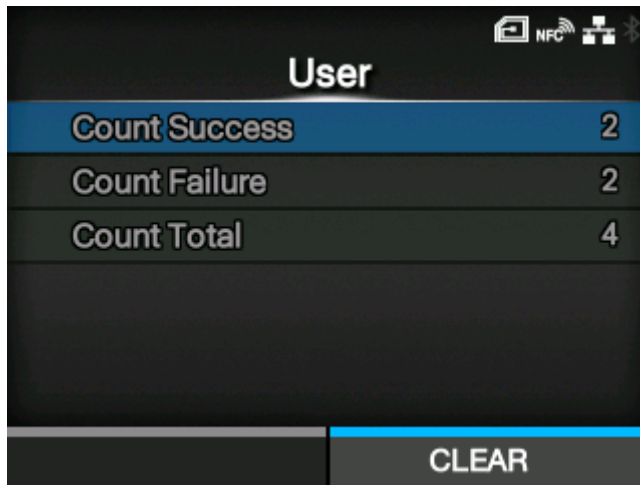

Shows the number of RFID write successes, failures, and total attempts after the RFID counter is cleared.

The display items are as follows:

Count Success

Shows the total number of successful times you have written to an RFID tag after the RFID counter is cleared.

Count Failure

Shows the total number of RFID write errors after the RFID counter is cleared.

Count Total

Shows the total number of times you have written to an RFID tag after the RFID counter is cleared.

This is the total number including [Count Success] and [Count Failure].



- You can reset the counter pressing the  button ([CLEAR]) when the counter is 1 or higher.

[Paper] U_{HF} H_F

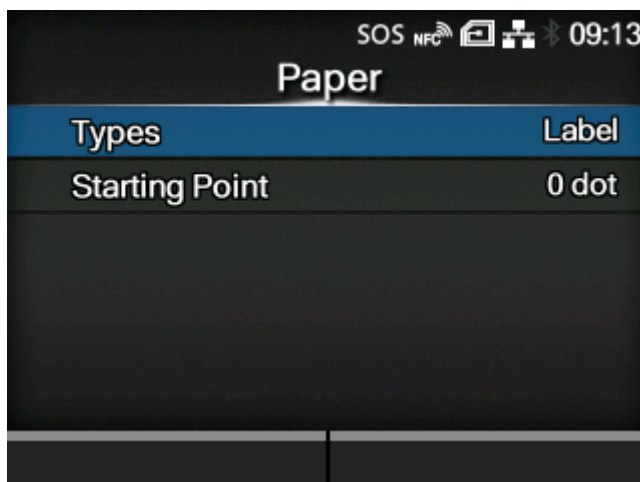

Set the paper type of RFID tags and the print reference position in the vertical direction.

The setting items are as follows:

Types

Set the paper type of RFID tags.

Starting Point

Set the print reference position of RFID tags in the vertical direction.

[Types] **U_{HF}** **H_F**

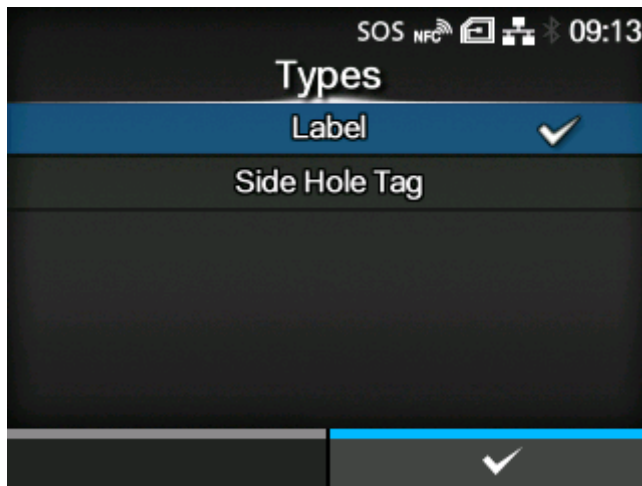

Set the paper type of RFID tags.

The options are as follows:

Label

Use normal RFID tags.

Side Hole Tag

Use side hole tags.

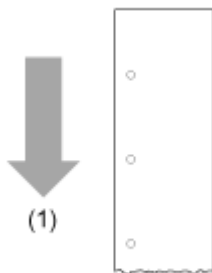

(1) Media feed direction

[Starting Point] UHF HF

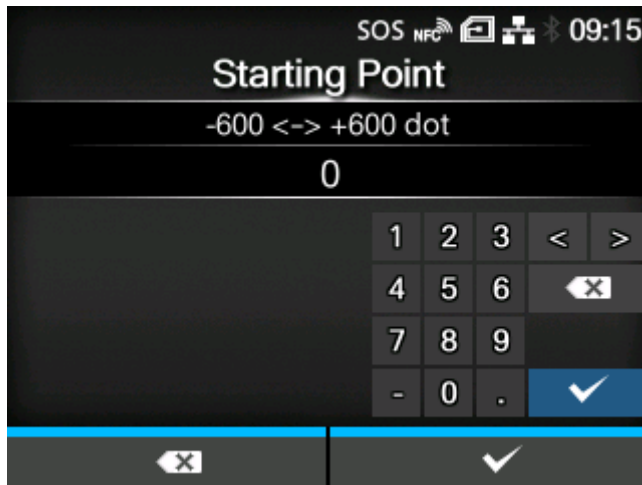

Set the print reference position of RFID tags in the vertical direction.

Set the print reference position as "+" for the direction of the paper feed and "-" for the direction opposite to the paper feed.

The setting range is from -600 to +600 dots.



- When the direction of the paper feed is set to "+", the total length including other pitch values should not exceed 25 mm (0.98"). If it exceeds 25 mm (0.98"), the product may not stop properly.



- The length of 1 dot varies depending on the print resolution of the product.
 - 203 dpi : 1 dot = 0.125 mm (0.0049")
 - 305 dpi : 1 dot = 0.083 mm (0.0033")
 - 609 dpi : 1 dot = 0.042 mm (0.0017")

[SATO RF Analyze] UHF HF

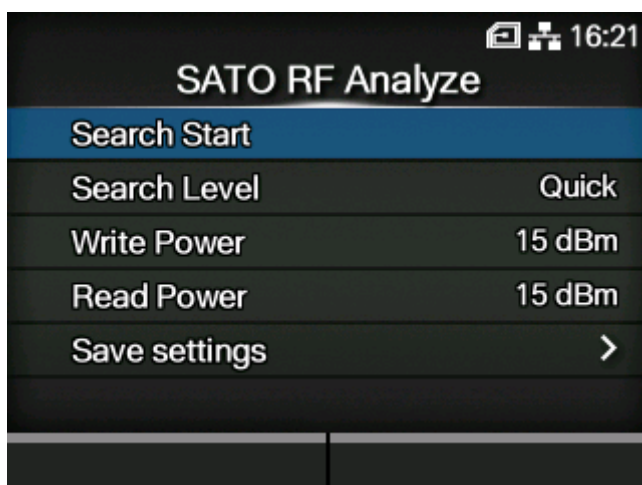

Set and execute the SATO RF Analyze function, and save the results of the measurements.

SATO RF Analyze is a function of the product that allows you to measure RFID tags and easily set conditions to consistently write and read them.

Appears only if the module is UHF.

The setting items are as follows:

[Search Start](#)

Execute SATO RF Analyze.

[Search Level](#)

Set the search level for SATO RF Analyze.

[Write Power](#)

Set radio power level used to write information to inlay.

[Read Power](#)

Set radio power level used to read information from inlay.

[Save settings](#)

Name the results of the SATO RF Analyze and save them as an RFID tag model.

[Search Start]  

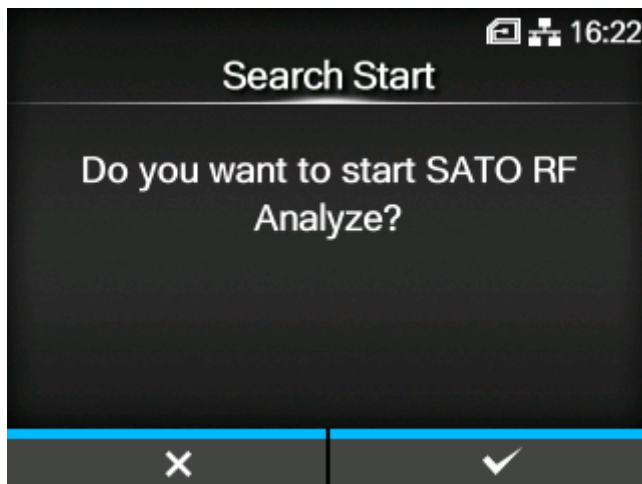

Execute SATO RF Analyze.

Set the measurement conditions as needed in [Search Level], [Write Power], [Read Power], and [Save settings] before executing.

Load RFID tags into the product, and press the  button. Measurement of the RFID tag starts, and the state of the measurement appears on the screen. Complete the measurement according to the on-screen instructions.

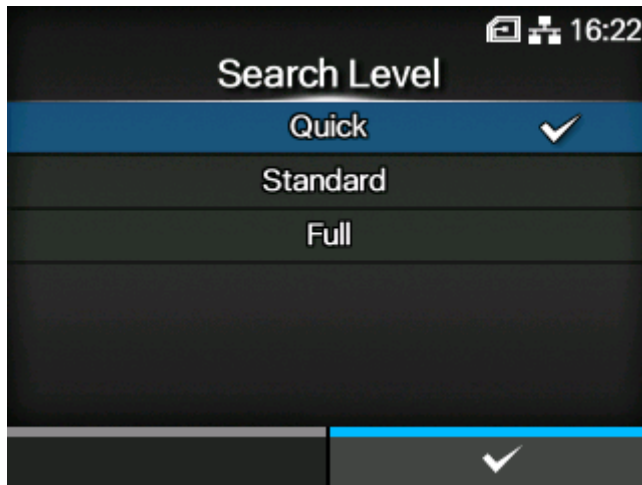

- The length from the leading edge of the tag to the inlay should be 15 mm (0.59") or more.
- The tag length should be 42 mm (1.65") or more (including liner) to execute SATO RF Analyze.

[Search Level] U_{HF} H_i

Set the search level for SATO RF Analyze.

The options are as follows:

- [Quick]
- [Standard]
- [Full]

If the measurement is not successful using [Quick], which is the initial setting, try [Standard] and [Full], which require more time and are more precise measurements.

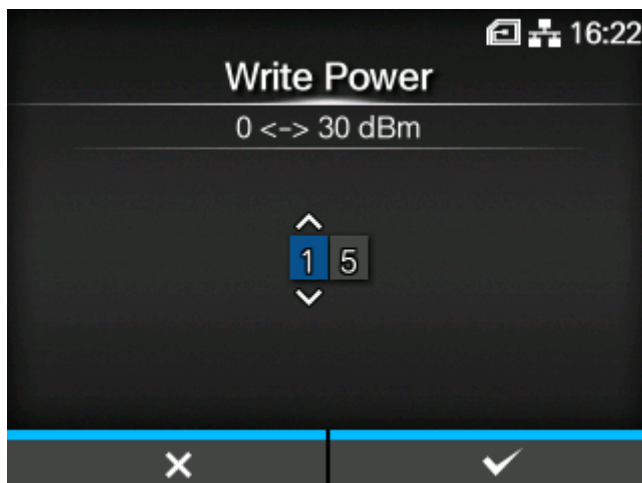
[Write Power] U_{HF} H_i

Set radio power level used to write information to inlays according to the Inlay Configuration Guide. For details, access the following URL:

<https://www.sato-global.com/rfid/guide.html>

To use inlays that are not in the Inlay Configuration Guide, use the initial values. If a SATO RF Analyze fails, a message to adjust the power output value by +1 dBm or -1 dBm, according to the cause, appears. Press the  button to execute adjustment, and then do the measurement again.

The setting range is from 0 to 30 dBm.

The setting range differs depending on where the product is being operated.



- Keep the setting value 24 dBm or less.
- The changes to this setting are linked and are changed with the settings in the [RFID] > [Write Power] menu.

[Read Power] UHF HF

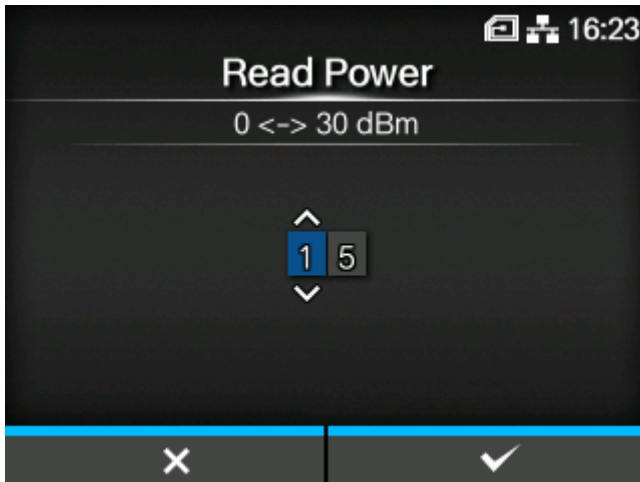

Set radio power level used to read information from inlays according to the Inlay Configuration Guide. For details, access the following URL:

<https://www.sato-global.com/rfid/guide.html>

To use inlays that are not in the Inlay Configuration Guide, use the initial values. If a SATO RF Analyze fails, a message to adjust the power output value by +1 dBm or -1 dBm, according to the cause, appears. Press the  button to execute adjustment, and then do the measurement again.

The setting range is from 0 to 30 dBm.

The setting range differs depending on where the product is being operated.



- Keep the setting value 24 dBm or less.
- The changes to this setting are linked and are changed with the settings in the [RFID] > [Read Power] menu.

[Save settings] UHF HF

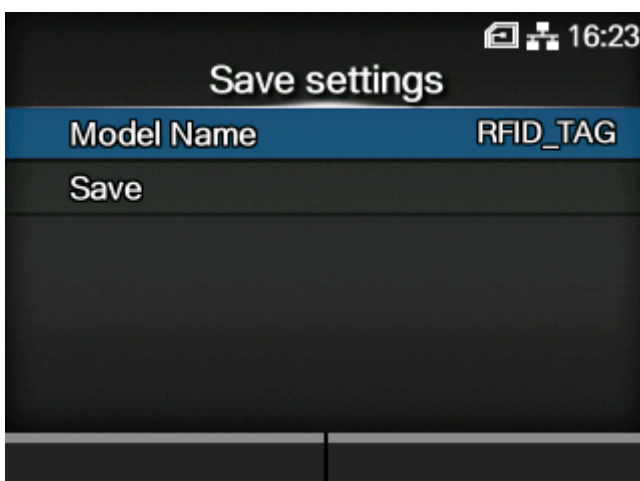

Name the results of the SATO RF Analyze and save them as an RFID tag model.

The setting items are as follows:

Model Name

Specify a model name when saving the results of the SATO RF Analyze.

Save

Save the results of the SATO RF Analyze as an RFID tag model.

[Model Name] UHF HF



Specify a model name when saving the results of the SATO RF Analyze.

You can enter a maximum of 32 characters. Alphabets, numbers and symbols can be used.

Press the  button to confirm.

[Save] UHF HF

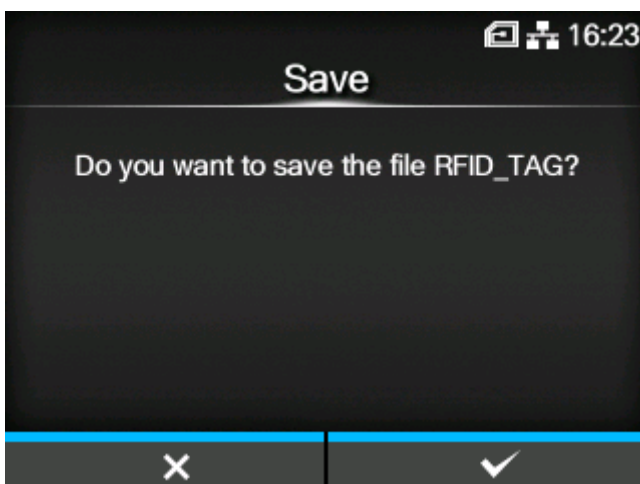

Save the results of the SATO RF Analyze as an RFID tag model.

You can register a maximum of 10 RFID tag models.

A confirmation screen appears when you select [Save] and press the  button. If the name you specify in [Model Name] is the same as an RFID tag model that is already registered, an overwrite confirmation message appears. Also, if you have already registered the maximum number of RFID tag

models, the message to confirm whether or not to delete the old RFID tag model and register the new one appears. Press the  button to save it.

[RFID Tag Model]  



Register, edit, read, and delete RFID tag models. The RFID tag model is a registered combination of the optimal antenna position, writing/reading power, and tag offset value for each type of RFID tag.

If you save the results of the SATO RF Analyze as an RFID tag model, you can manage them from this menu. Also, you can register RFID tag models manually from [Edit] in this menu.

You can register a maximum of 10 RFID tag models.

The setting items are as follows:

Load

Read a registered RFID tag model and apply the settings to the product.

Edit

Register a new RFID tag model or edit registered RFID tag models.

Delete

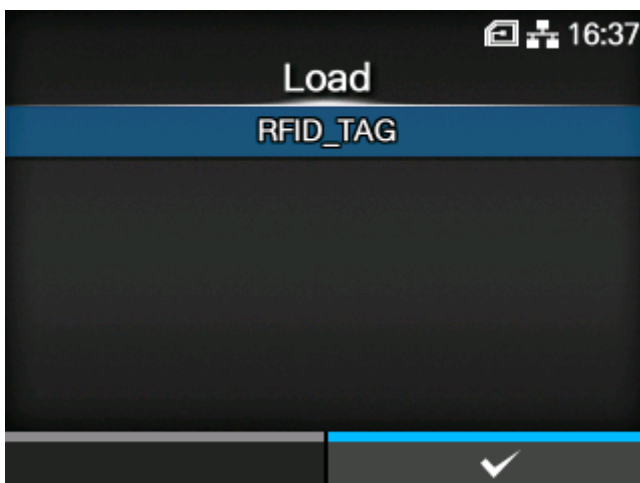

Delete registered RFID tag models.

[Load]  



Read a registered RFID tag model and apply the settings to the product.

You can use this if more than one RFID tag model has been registered.

Select the RFID tag model and press the  button to read, and then press the  button in the confirmation message.

The name of the RFID tag model that was read appears on the right side of [Load] on the [RFID Tag Model] menu.



- After you save the results of the SATO RF Analyze as an RFID tag model, their name appears on the right side of [Load] on the [RFID Tag Model] menu as the current settings of the product.

[Edit]  

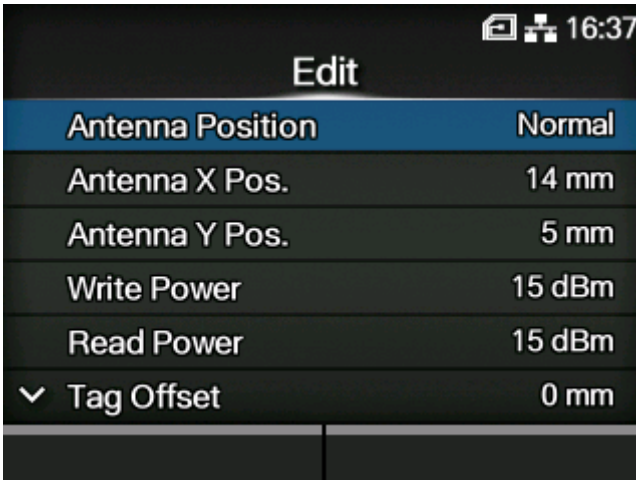

Edit	
Antenna Position	Normal
Antenna X Pos.	14 mm
Antenna Y Pos.	5 mm
Write Power	15 dBm
Read Power	15 dBm
✓ Tag Offset	0 mm

Register a new RFID tag model or edit registered RFID tag models.

To edit registered RFID tag models, read the targeted RFID tag model in advance in the [Load] menu.

For information needed for these settings, refer to the Inlay Configuration Guide. To view the Inlay Configuration Guide, access the following URL:

<https://www.sato-global.com/rfid/guide.html>

To use inlays that are not in the Inlay Configuration Guide, contact your SATO sales representative or reseller.

The setting items are as follows:

[Antenna Position](#)

Set an RFID antenna to use.

[Antenna X Pos. \(UHF only\)](#)

Adjust the position of the RFID standard antenna in the horizontal direction.

[Antenna Y Pos. \(UHF only\)](#)

Adjust the position of the RFID standard antenna in the vertical direction.

[Write Power \(UHF only\)](#)

Set radio power level used to write information to inlays.

[Read Power \(UHF only\)](#)

Set radio power level used to read information from inlays.

[Tag Offset](#)

Set the position at which to start writing data to the inlay.



Pitch Size (UHF only)

Set the length of the RFID tag.

When the settings are complete, select [Save as], press the  button, and input a name.



You can enter a maximum of 32 characters. Alphabets, numbers and symbols can be used.

After inputting a name, press the  button, and press the  button in the confirmation screen to confirm.

If you specify a name that is the same as a registered RFID tag model, a confirmation message appears. To overwrite the settings, press the  button.

[Antenna Position] UHF HF

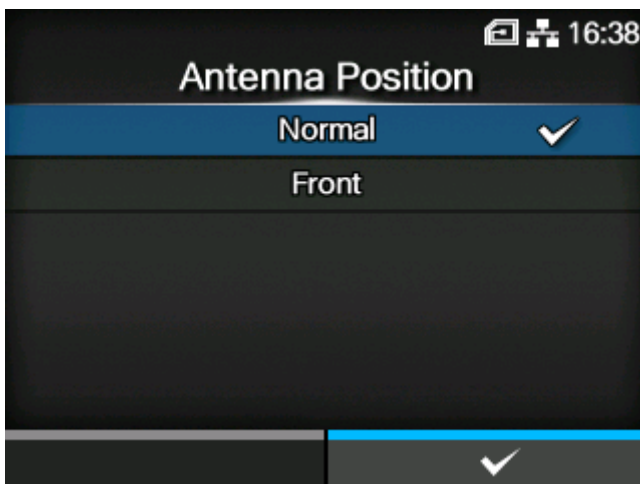

Select an RFID antenna to use.

If the installed module is UHF

The options are as follows:

Normal

Use a standard antenna (adjustable).

With the SATO RF Analyze function, you can automatically adjust the position of the standard antenna to suit the RFID tag you are using. You can record the results of the automatic

adjustment in [RFID Tag Model]. Or, you can manually adjust the position of the standard antenna with [RFID Tag Model].

Front

Use a short pitch antenna (fixed position).

If the installed module is HF

Use a standard antenna. Specify the position on the standard antenna in the vertical direction.

The options are as follows:

- [Forward]
- [Center]
- [Backward]

[Antenna X Pos.] UHF Hi

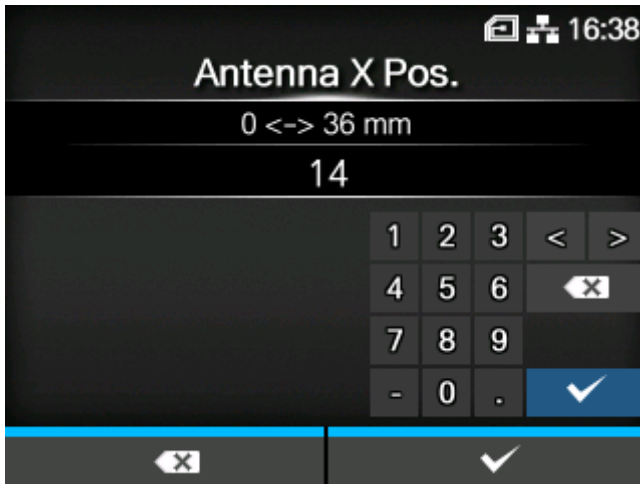

Adjust the position of the RFID standard antenna in the horizontal direction.

Appears only if the installed module is UHF.

The setting range is from 0 to 36 mm (0 to 1.42").

[Antenna Y Pos.] UHF Hi



Adjust the position of the RFID standard antenna in the vertical direction.

Appears only if the installed module is UHF.

The setting range is from 0 to 30 mm (0 to 1.18")

[Write Power] UHF HF

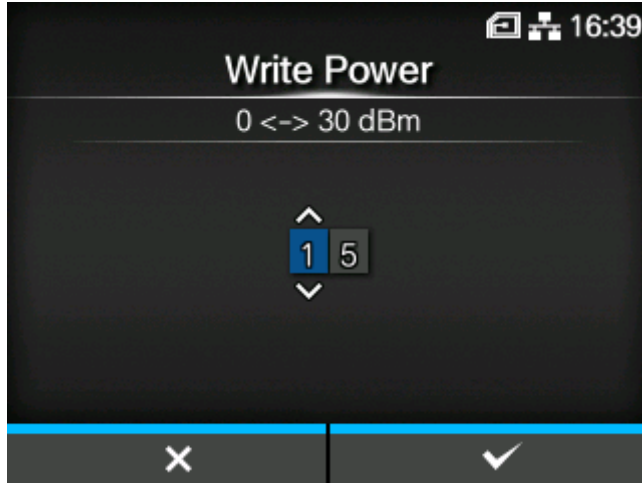

Set radio power level used to write information to inlays.

Appears only if the installed module is UHF.

The setting range is 0 to 30 dBm.

The setting range differs depending on where the product is being operated.



- The changes to this setting are linked and are changed with the settings in the [SATO RF Analyze] > [Write Power] menu.

[Read Power] UHF HF

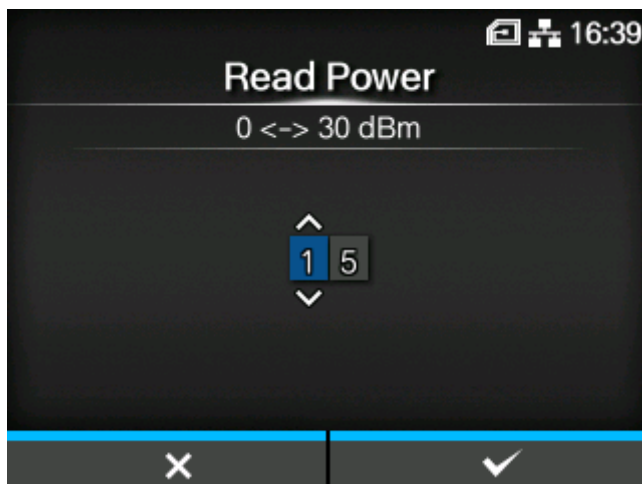

Set radio power level used to read information from inlays.

Appears only if the installed module is UHF.

The setting range is 0 to 30 dBm.

The setting range differs depending on where the product is being operated.



- The changes to this setting are linked and are changed with the settings in the [SATO RF Analyze] > [Read Power] menu.

[Tag Offset] UHF HF

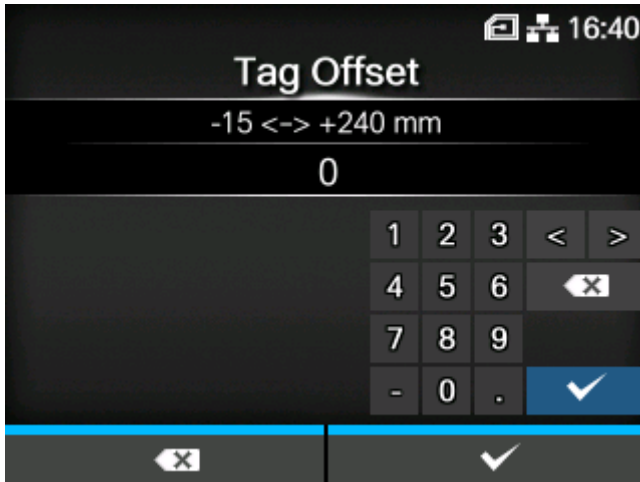

Set the position at which to start writing data to the inlay. Data is written to an inlay on each tag at the point where the inlay passes over the product's RFID antenna, which is at the distance, from the print start position, specified in this setting.

The setting range is from -15 to 240 mm (-0.59 to 9.45").

The minimum value is 0 mm (0") if other than [Continuous] is selected in the [Printing] > [Print Mode] menu.

[Pitch Size] UHF HF

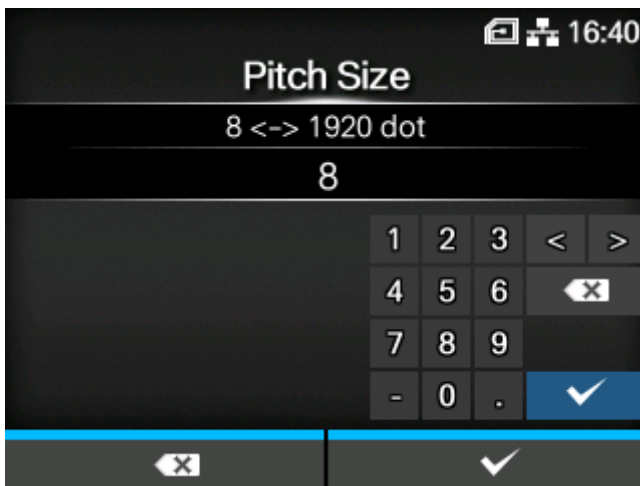

Set the length of the RFID tag.

Appears only if the installed module is UHF.

The setting range varies depending on the print resolution of the product.

The setting range of the RFID tag length is as follows:

Resolution	Setting range
203 dpi (1 dot = 0.125 mm (0.0049"))	8 to 1920 dots

Resolution	Setting range
305 dpi (1 dot = 0.083 mm (0.0033"))	12 to 2880 dots
609 dpi (1 dot = 0.042 mm (0.0017"))	24 to 5760 dots



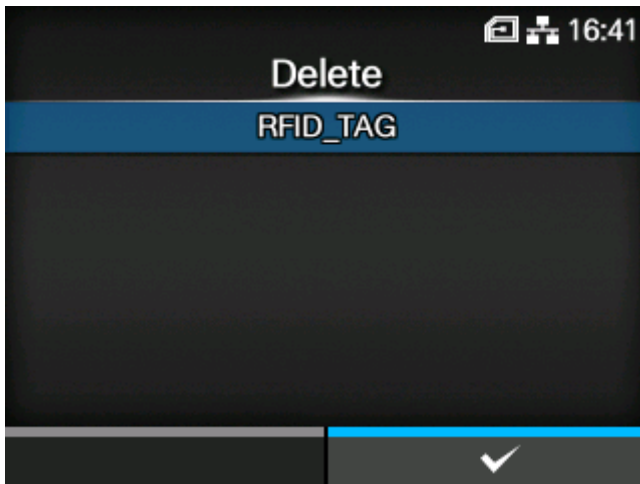

- You can change the units to dots, " (inches), or mm in the [System] > [Regional] > [Unit] menu.
- Set a value that includes the liner.

[Delete] UHF HF



Delete registered RFID tag models.

You can use this if more than one RFID tag model has been registered.

Select the RFID tag model to delete and press the  button, and then press the  button in the confirmation message.

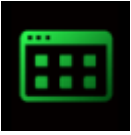

[Applications] Menu

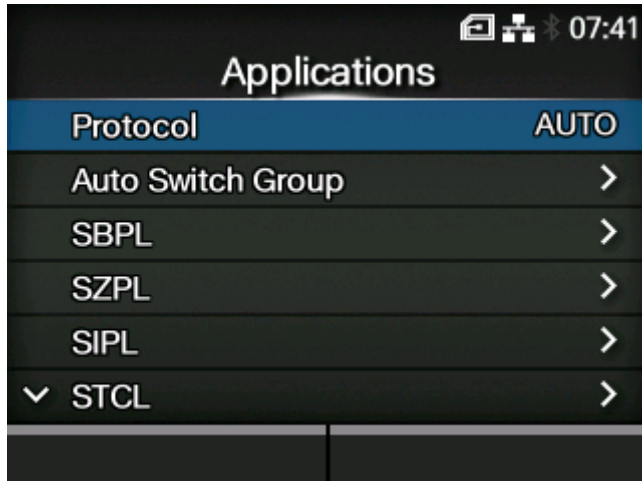

The following settings are available in the [Applications] menu:

[Protocol](#)

Set the printer language.

[Auto Switch Group](#)

Set the printer commands to switch automatically.

- Appears only if you have selected [AUTO] in the [Protocol] menu.

[SBPL](#)

Set the SBPL printer command.

[SZPL](#)

Set the SZPL printer command.

[SIPL](#)

Set the SIPL printer command.

[STCL](#)

Set the STCL printer command.

[SDPL](#)

Set the SDPL printer command.

[SEPL](#)

Set the SEPL printer command.

[AEP](#)

Set the functions for AEP (Application Enabled Printing).

[Protocol]

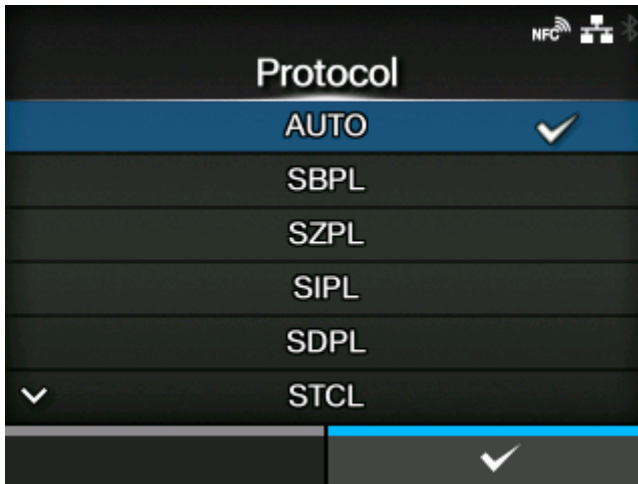

Set the printer language.

The options are as follows:

AUTO

Automatically analyze the received print data and set the printer language. In [AUTO] mode, the product can change the language after startup by receiving another language.

SBPL

Set when you use the SBPL printer language or XML.

SZPL

Set when you use the SZPL printer language.

SIPL

Set when you use the SIPL printer language.

SDPL

Set when you use the SDPL printer language.

STCL

Set when you use the STCL printer language.

SEPL

Set when you use the SEPL printer language.

 (When [AUTO] is selected in the [Protocol] menu)

- A message prompting you to restart the product will appear on the Online/Offline screen if you select [AUTO]. In such a case, reboot the product to apply the settings.
- Once the printer language is fixed, the name of the printer language will appear on the Online/Offline screen. The area to show the name of the printer language will remain blank until the printer language is finalized.

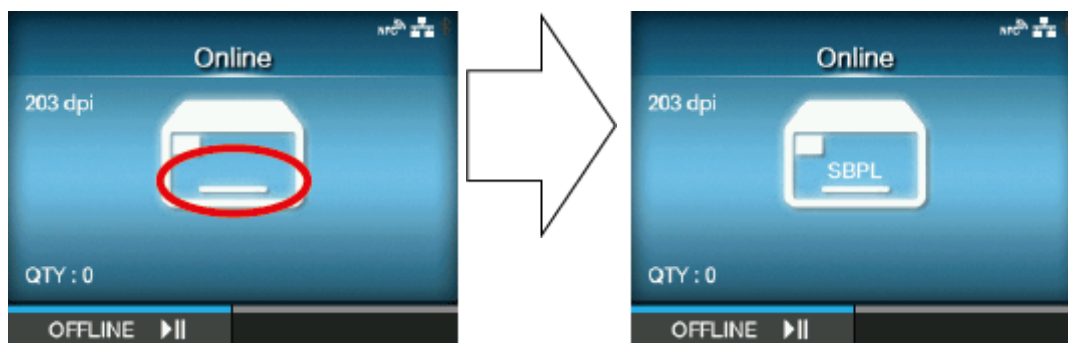

The area remains blank until the printer language is finalized.

When the print data has been sent in SBPL.

- Printer language is finalized with the received print data.
- When [SBPL] > [Standard Code] in the [Applications] menu is disabled, the [Protocol] setting will be changed to [SBPL].

[Auto Switch Group]

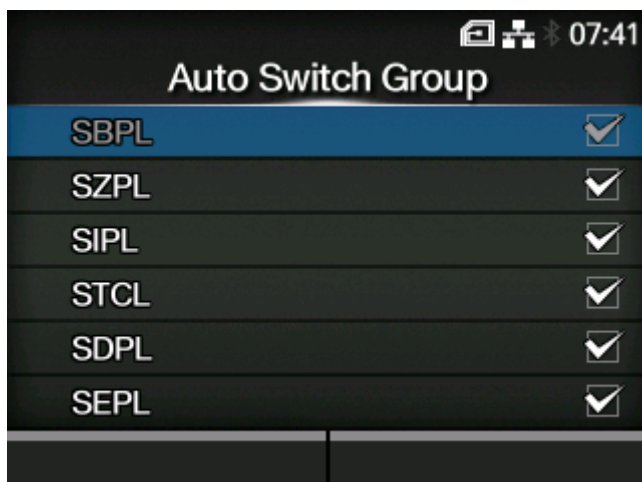

Set the printer languages to switch automatically.

The options are as follows:

[SBPL](#)

Enable or disable the SBPL printer language.

[SZPL](#)

Enable or disable the SZPL printer language.

[SIPL](#)

Enable or disable the SIPL printer language.

[STCL](#)

Enable or disable the STCL printer language.

[SDPL](#)

Enable or disable the SDPL printer language.

[SEPL](#)

Enable or disable the SEPL printer language.



- The printer language set in [AUTO] mode is grayed out.
-

[SBPL]

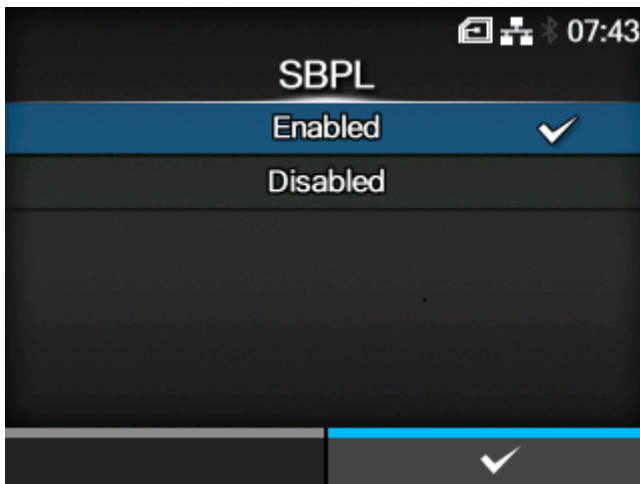

Enable or disable the SBPL printer language.

The options are as follows:

Enabled

Enable the SBPL printer language.

Disabled

Disable the SBPL printer language.

[SZPL]

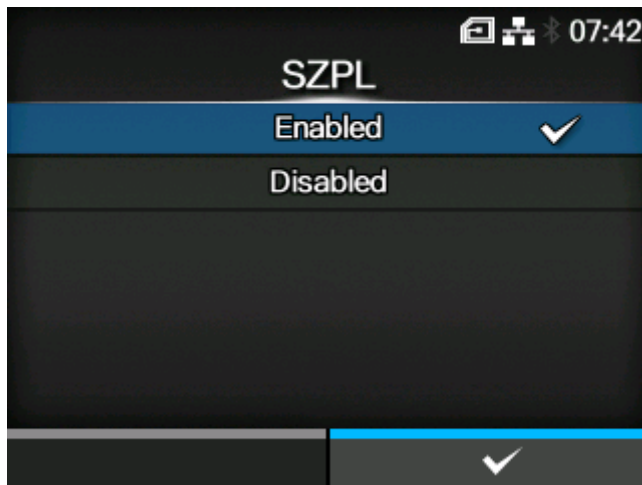

Enable or disable the SZPL printer language.

The options are as follows:

Enabled

Enable the SZPL printer language.

Disabled

Disable the SZPL printer language.

[SIPL]

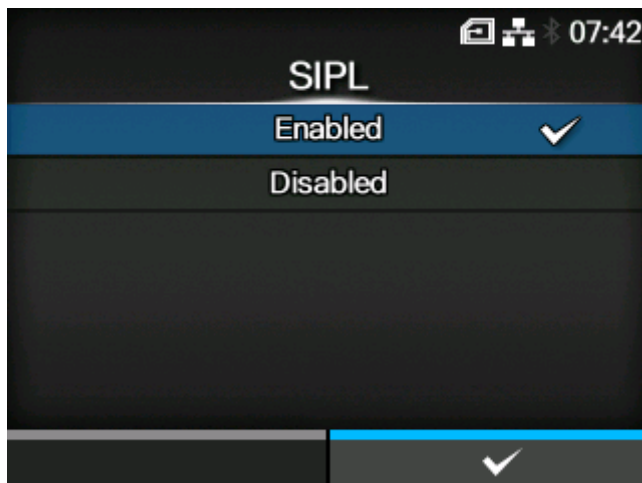

Enable or disable the SIPL printer language.

The options are as follows:

Enabled

Enable the SIPL printer language.

Disabled

Disable the SIPL printer language.

[STCL]

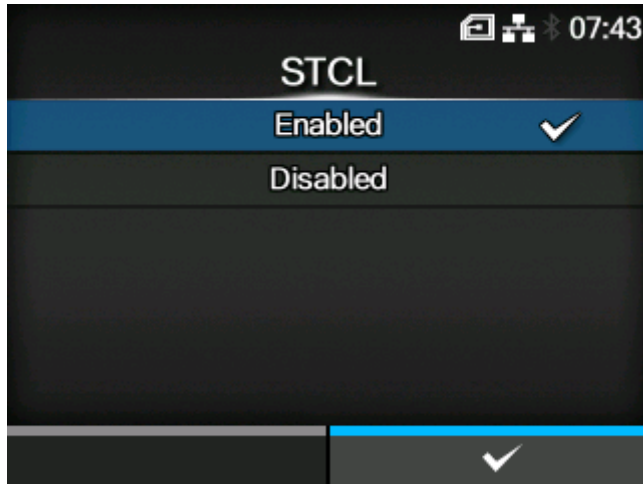

Enable or disable the STCL printer language.

The options are as follows:

Enabled

Enable the STCL printer language.

Disabled

Disable the STCL printer language.

[SDPL]

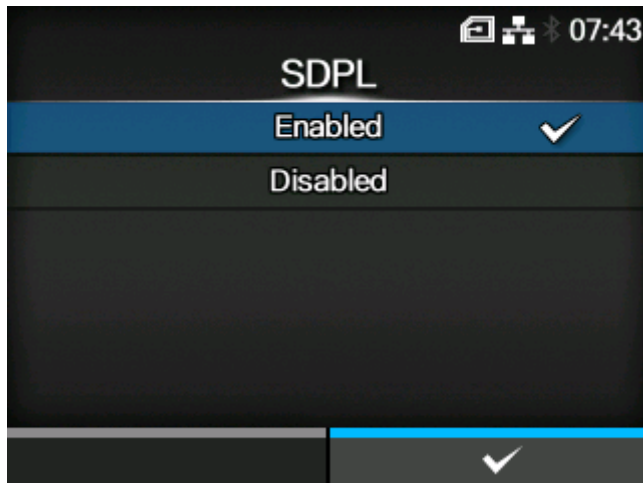

Enable or disable the SBPL printer language.

The options are as follows:

Enabled

Enable the SDPL printer language.

Disabled

Disable the SDPL printer language.

[SEPL]

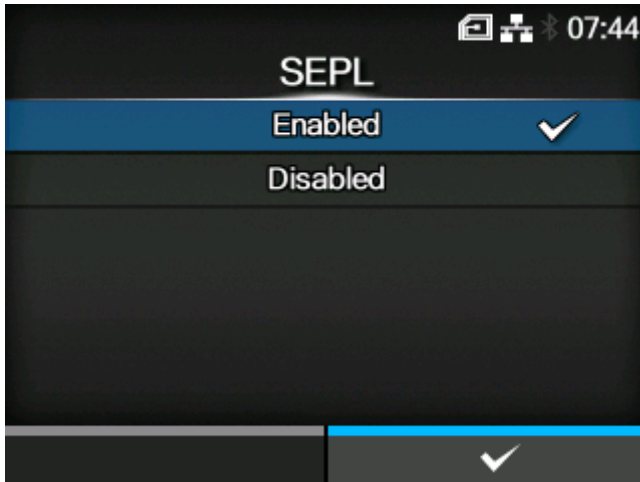

Enable or disable the SEPL printer language.

The options are as follows:

Enabled

Enable the SEPL printer language.

Disabled

Disable the SEPL printer language.

[SBPL]

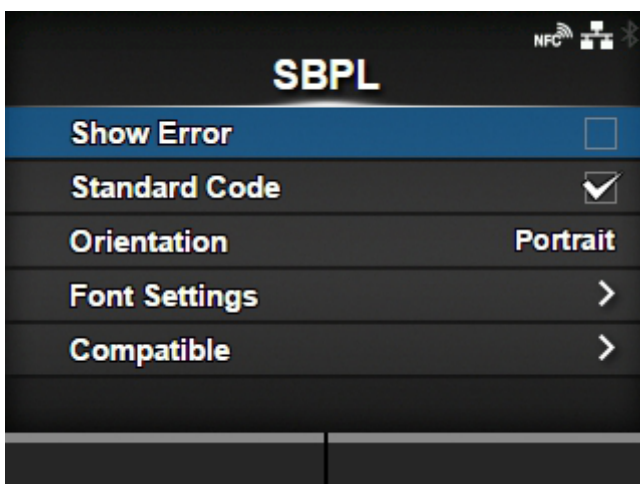

SBPL (SATO Barcode Printer Language) is the common command that controls SATO barcode label printers.

To use SBPL as a printer command, set the following items:

[Show Error](#)

Enable or disable the command error indication.

[Standard Code](#)

Set the protocol code.

[Orientation](#)

Set the layout for printing.

[Font Settings](#)

Set the font.

[Compatible](#)

Set the compatible code.

[Show Error]

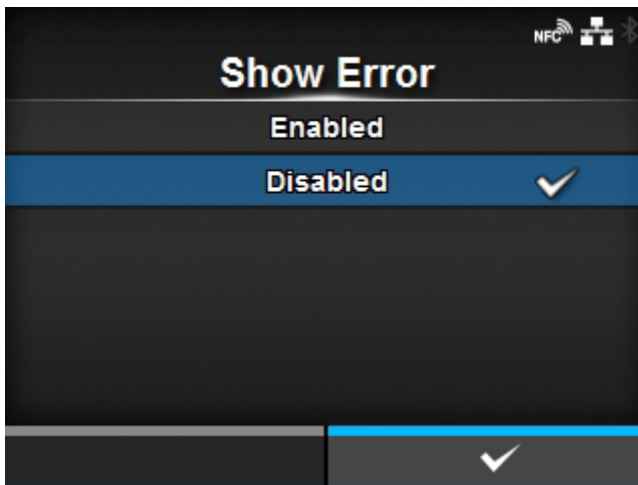

Enable or disable the command error indication when incorrect command or parameter is detected in the print data.

The options are as follows:

Enabled

The error screen is displayed. The print operation is paused.

Disabled

The error screen is not displayed, but the command error status icon appears in the status bar.

[Standard Code]

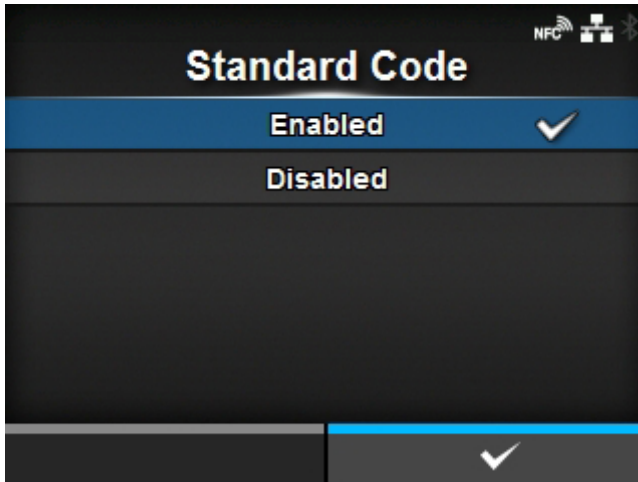

Set the protocol code.

The options are as follows:

Enabled

Use a standard code.

Disabled

Use a non-standard code.



- A message prompting you to restart the product will appear on the Online/Offline screen if you have made any changes. In such a case, reboot the product to apply the settings. When [AUTO] is selected in the [Protocol] menu while [Disabled] is selected, the setting will be changed to [Enabled].

[Orientation]

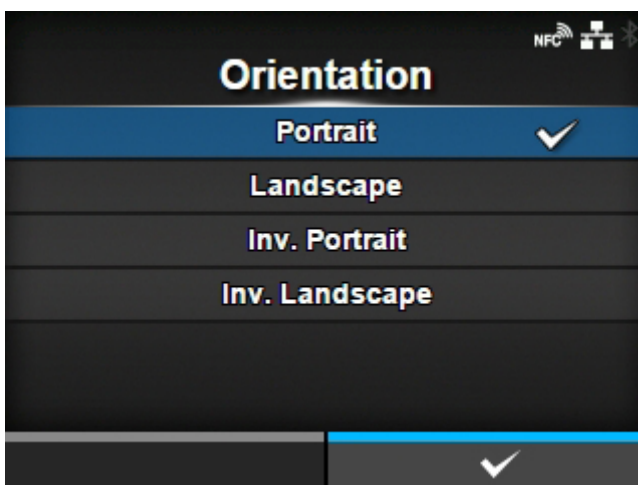

Select the layout for printing the label.

Portrait

Use a portrait layout. (No rotation)

Landscape

Use a landscape layout. (90-degree rotation)

Inv. Portrait

Use an inverse portrait layout. (180-degree rotation)

Inv. Landscape

Use an inverse landscape layout. (270-degree rotation)

[Font Settings]

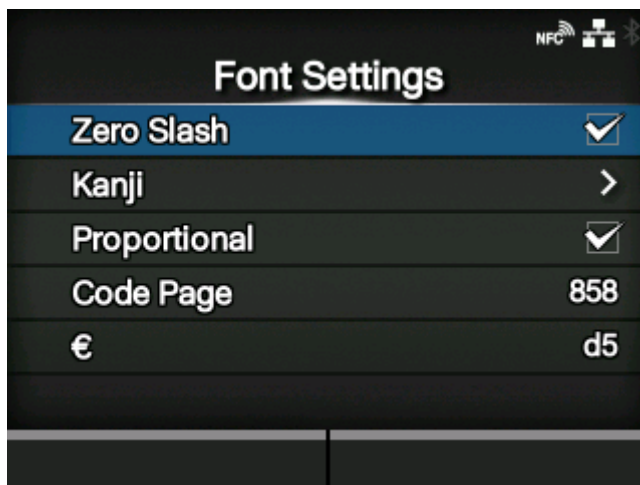

Set the font.

The setting items are as follows:

[Zero Slash](#)

Set the type for printing zero.

[Kanji](#)

Set the kanji code to be used.

[Proportional](#)

Set the character pitch for printing.

[Code Page](#)

Set the code page to be used.

[€](#)

Set the European currency symbol to the ASCII code.

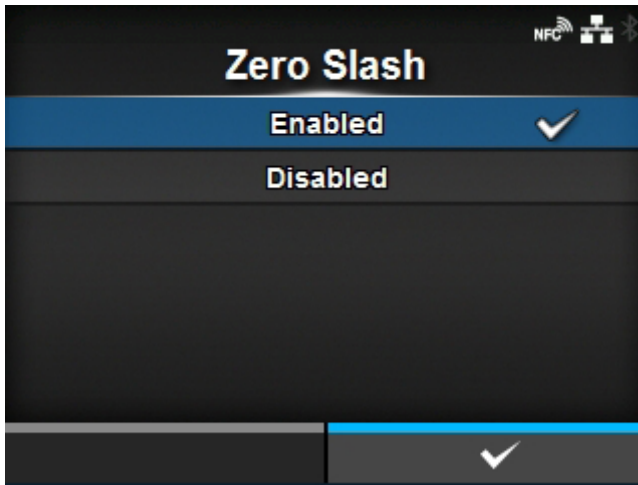
[Zero Slash]

Set whether to print the number zero (0) with or without a slash (/).

This setting is applied to the following bitmap fonts:

U, S, M, WB, WL, XU, XS, XM, XL, X20, X21, X22, X23, X24

The options are as follows:

Enabled

Print zero with a slash.

Disabled

Print zero without a slash.

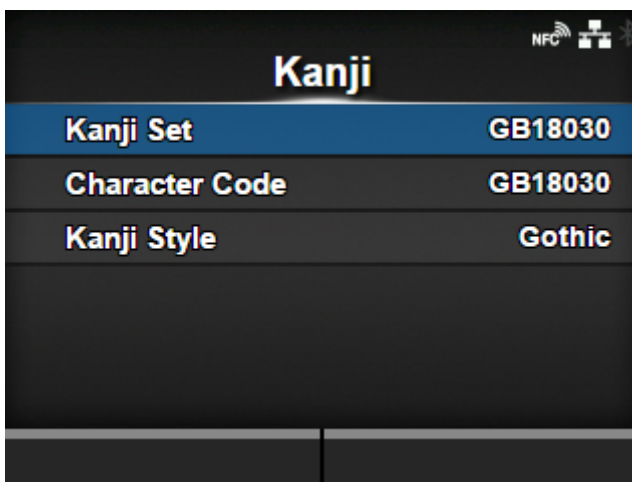
[Kanji]

Set the kanji code to be used.

The setting items are as follows:

Kanji Set

Set the kanji code to be used.

Character Code

Set the character code to be used.

[Kanji Style](#)

Set the font to be used.

[Kanji Set]

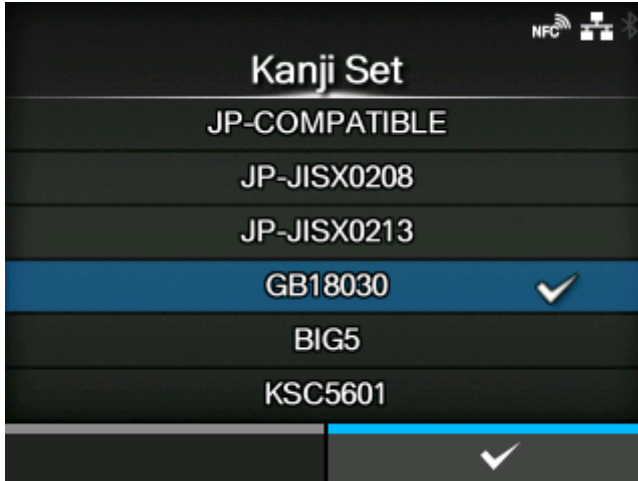

Set the kanji code to be used.

The options are as follows:

- [JP-COMPATIBLE]
- [JP-JISX0208]
- [JP-JISX0213]
- [GB18030]
- [BIG5]
- [KSC5601]

[Character Code]

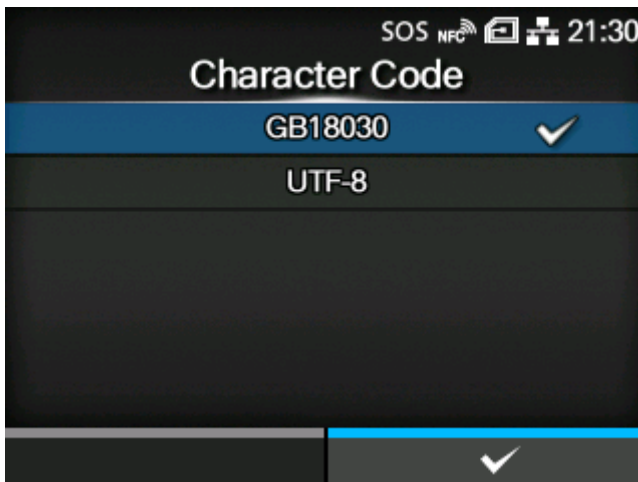

Set the character code to be used.

The options vary depending on the kanji code set in the [Kanji Set]:

- **When set to [JP-COMPATIBLE] or [JP-JISX0208]**
 - [JIS]

- [SJIS]
- [UTF-16]
- [UTF-8]

- **When set to [JP-JISX0213]**
 - [SJIS]
 - [UTF-16]
 - [UTF-8]

- **When set to [GB18030]**
 - [GB18030]
 - [UTF-8]

- **When set to [BIG5]**
 - [BIG5]
 - [UTF-8]

- **When set to [KSC5601]**
 - [KSC5601]
 - [UTF-8]

[Kanji Style]

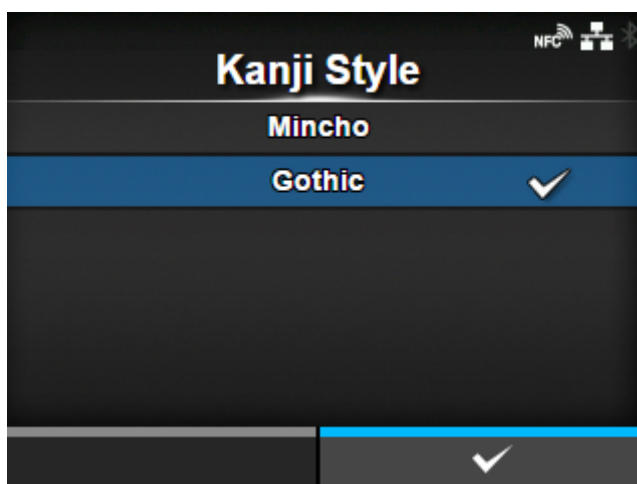

Set the font to be used.

The options are as follows:

- [Mincho]
- [Gothic]

[Proportional]

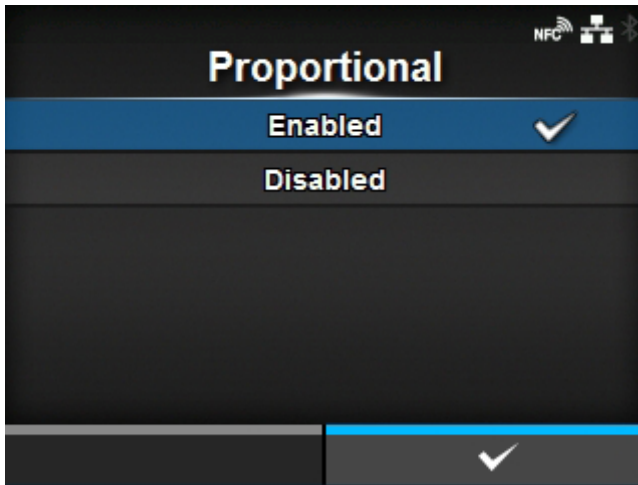

Set whether to print each character using a proportional pitch or fixed pitch.

The options are as follows:

Enabled

Print each character with a proportional pitch.

Disabled

Print all characters with a fixed pitch.

[Code Page]

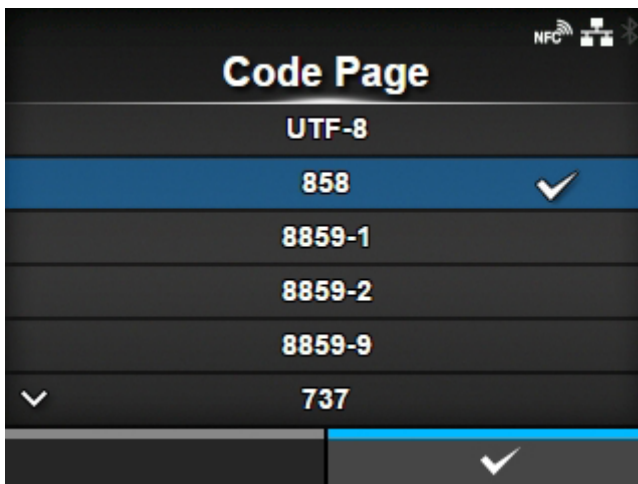

Select the code page to be used from the list.

[€]

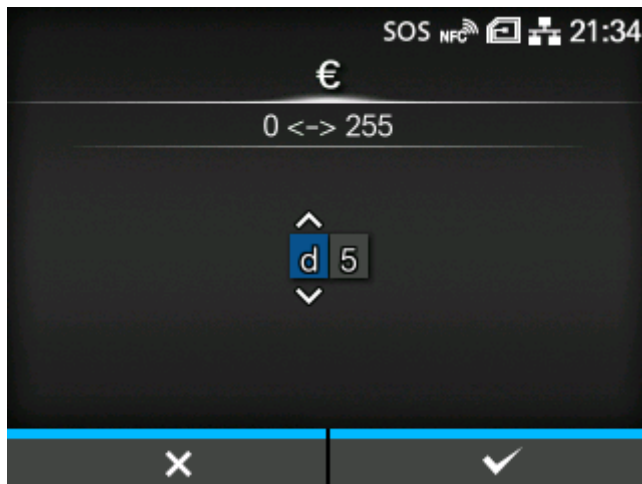

Set the European currency symbol to the ASCII code.
The setting range is from 00 to ff (hexadecimal).

[Compatible]

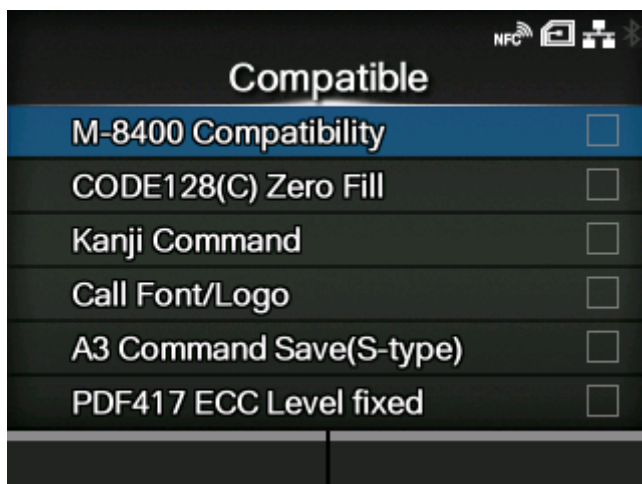

Set the compatible code for SBPL.

The setting items are as follows:

[M-8400 Compatibility](#)

Enable or disable the M-8400 printer compatibility function.

[CODE128\(C\) Zero Fill](#)

Set whether to allow odd digits and print the barcode with zero-filling at the end of the data when start code C is used in CODE128.

- If [M-8400 Compatibility] is set to [Enabled], this setting is automatically enabled and does not appear.

[Kanji Command](#)

Set the product behavior when the received data includes the Kanji command ESC+K5, ESC+K6 or ESC+K7.

[Call Font/Logo](#)

Set how to process the character code specified in Recall font & logo command (ESC+RF).

[A3 Command Save\(S-type\)](#)

Set whether to save all values (with or without +/- sign) specified by the Base Reference Point command ESC+A3 to the product's [Imaging] menu.

[PDF417 ECC Level fixed](#)

Set whether to print the PDF417 code with the security level specified by the PDF417 printing command.

[M-8400 Compatibility]

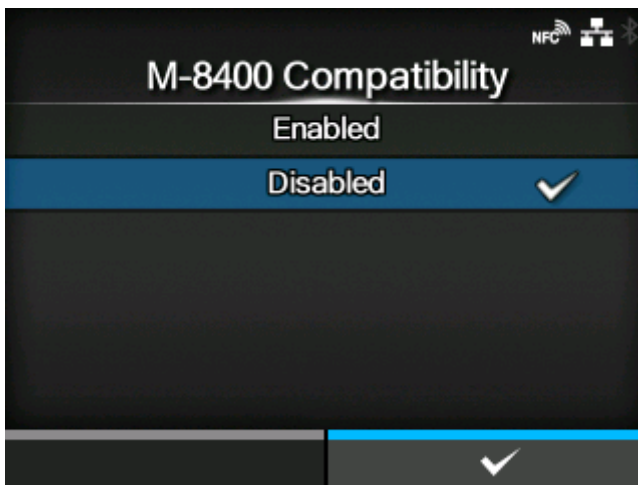

Enable or disable the M-8400 printer compatibility function.

The options are as follows:

Enabled

Enable the M-8400 printer compatibility function.

Disabled

Disable the M-8400 printer compatibility function.



- Contact your SATO sales representative for more information about the M-8400 printer compatibility function.
 - If [M-8400 Compatibility] is set to [Enabled], [CODE128(C) Zero Fill] is automatically enabled and the setting item does not appear.
-

[CODE128(C) Zero Fill]

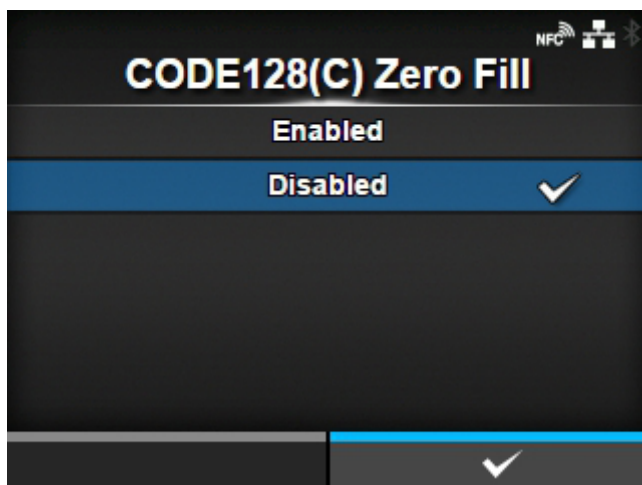

Set whether to allow odd digits and print the barcode with zero-filling at the end of the data when start code C is used in CODE128.

If [M-8400 Compatibility] is set to [Enabled], this setting is automatically enabled and does not appear.

The options are as follows:

Enabled

Allow odd digits and print the barcode with zero-filling.

Disabled

Do not allow odd digits. A command error occurs and the barcode will not be printed.

[Kanji Command]

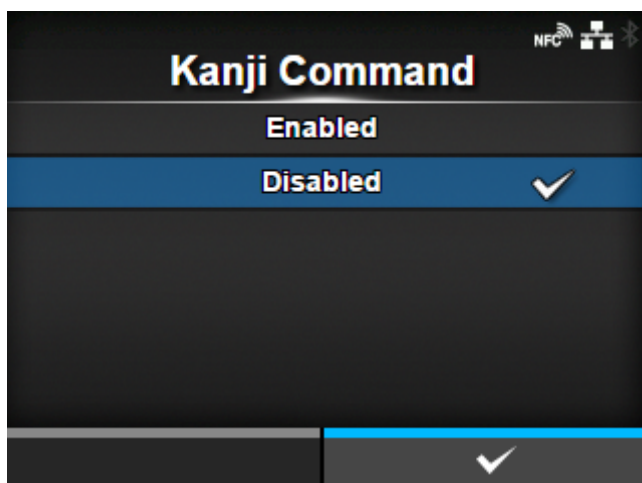

Set the product behavior when the received data includes the Kanji command ESC+K5, ESC+K6 or ESC+K7.

The options are as follows:

Enabled

Change the Kanji commands ESC+K5, ESC+K6 and ESC+K7 in the received data to the proper commands and print.

- ESC+K5: 16x16 dots Kanji in horizontal line with one-byte character

- ESC+K6: 24x24 dots Kanji in horizontal line with one-byte character
- ESC+K7: 22x22 dots Kanji in horizontal line

Disabled

Do not change the Kanji commands ESC+K5, ESC+K6 and ESC+K7 in the received data. The product behavior when it receives these commands is as follows:

- ESC+K5: Print with 40x40 dots Kanji in horizontal line.
- ESC+K6: A command error occurs and the data will not be printed.
- ESC+K7: A command error occurs and the data will not be printed.

[Call Font/Logo]

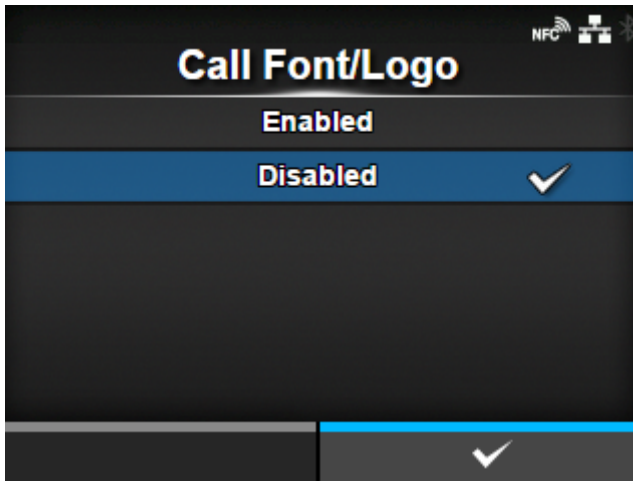

Set how to process the character code specified in Recall font & logo command (ESC+RF).

The options are as follows:

Enabled

Character codes are processed in little-endian format.

Disabled

Character codes are processed in big-endian format.

[A3 Command Save(S-type)]

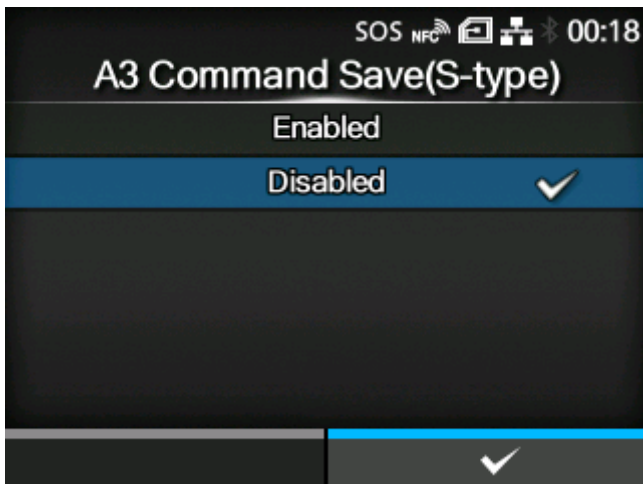

Set whether to save all values (with or without +/- sign) specified by the Base Reference Point command ESC+A3 to the product's [Imaging] menu.

The options are as follows:

Enabled

All values (with or without +/- sign) specified by the command ESC+A3 are saved to the product's [Imaging] menu.

Disabled

Only values without +/- sign specified with the command ESC+A3 are saved to the product's [Imaging] menu. Values with +/- sign are not saved.

[PDF417 ECC Level fixed]

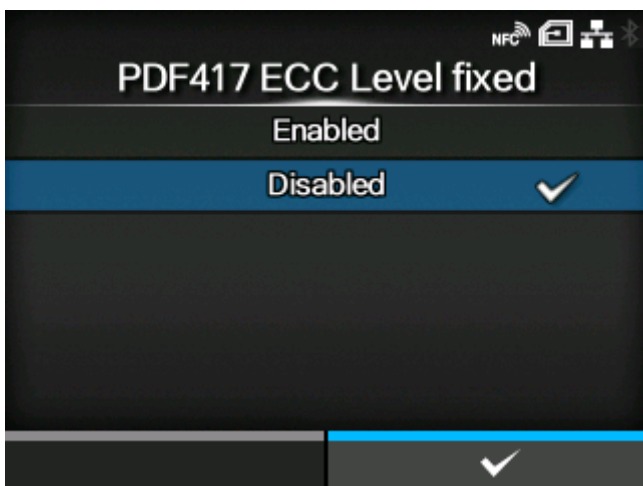

Set whether to print the PDF417 code with the security level specified by the PDF417 printing command.

The options are as follows:

Enabled

Print the PDF417 code with the security level specified by the PDF417 printing command.

Disabled

Print the PDF417 code with the security level specified by the PDF417 (or higher) printing command.

[SZPL]



SZPL	
Label	>
Label Rotation	0 degree
Caret	94
Delimiter	44
Tilde	126
▼ Clock Format	(none)

To use SZPL as a printer command, set the following items:

[Label](#)

Set the print position.

[Label Rotation](#)

Set the page orientation for label printing.

[Caret](#)

Set the caret (^) code.

[Delimiter](#)

Set the delimiter (,) code.

[Tilde](#)

Set the tilde (~) code.

[Clock Format](#)

Set the date format.

[Default Font](#)

Select the default font for when printing using a multilingual font contained in the product.

[Label]

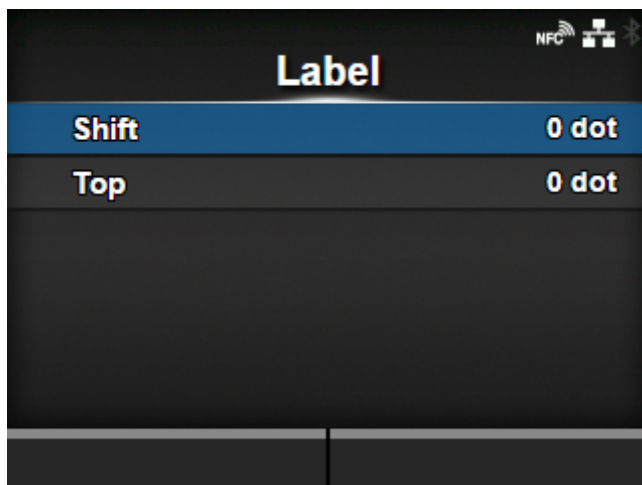

Set the print position.

The setting items are as follows:

[Shift](#)

Set the shift offset position of the label.

[Top](#)

Set the top offset position of the label.

[Shift]

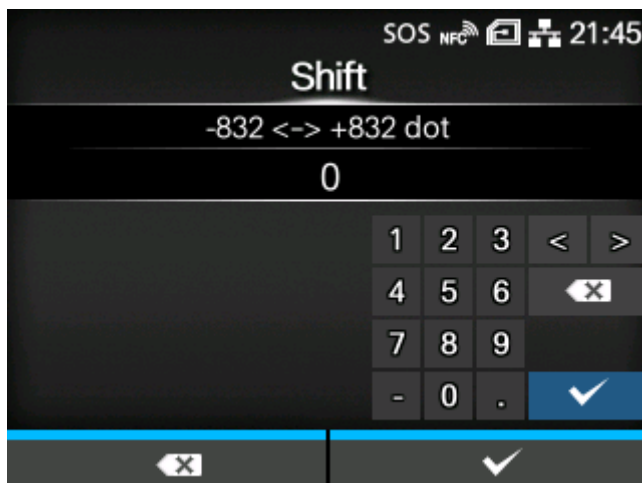

Set the shift offset position of the label.

The setting range varies depending on the print resolution of the product.

The setting range is as follows:

Resolution	CL4NX Plus	CL6NX Plus
203 dpi (1 dot = 0.125 mm (0.0049"))	-832 to 0 to 832 dots	-832 to 0 to 832 dots

Resolution	CL4NX Plus	CL6NX Plus
305 dpi (1 dot = 0.083 mm (0.0033"))	-1248 to 0 to 1248 dots	-1248 to 0 to 1248 dots
609 dpi (1 dot = 0.042 mm (0.0017"))	-2496 to 0 to 2496 dots	-

[\[Top\]](#)

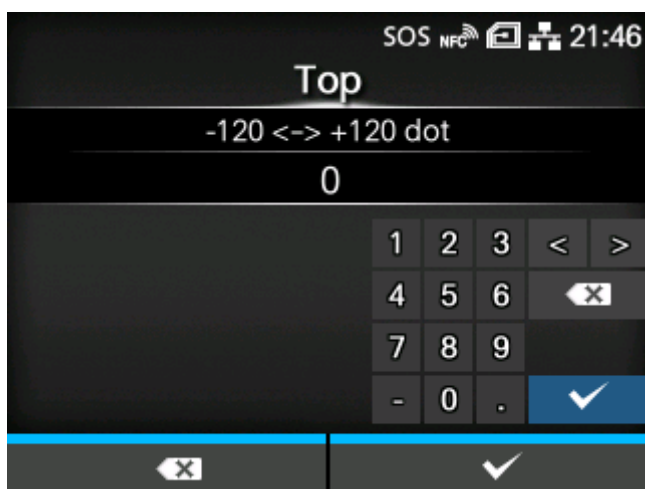

Set the top offset position of the label.

The setting range is from -120 to +120 dots.



- The length of 1 dot varies depending on the print resolution of the product.
 - 203 dpi : 1 dot = 0.125 mm (0.0049")
 - 305 dpi : 1 dot = 0.083 mm (0.0033")
 - 609 dpi : 1 dot = 0.042 mm (0.0017")
-

[Label Rotation]

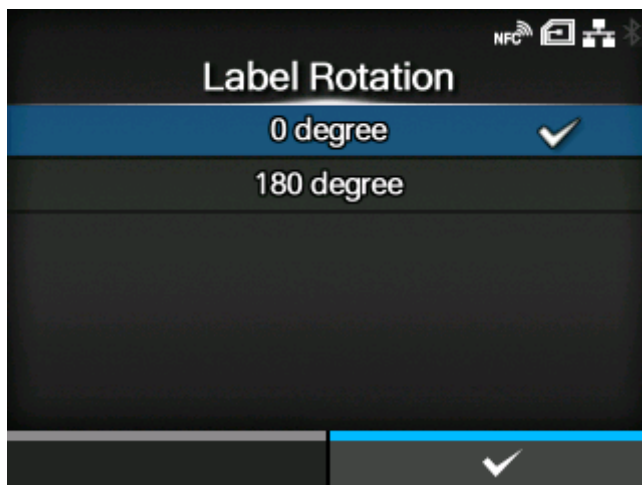

Set the page orientation for label printing.

The label size set in the product is used as a reference for rotation.

The options are as follows:

0 degree

Labels are printed in a portrait orientation.

180 degree

Labels are printed in an inverse-portrait orientation.

[Caret]

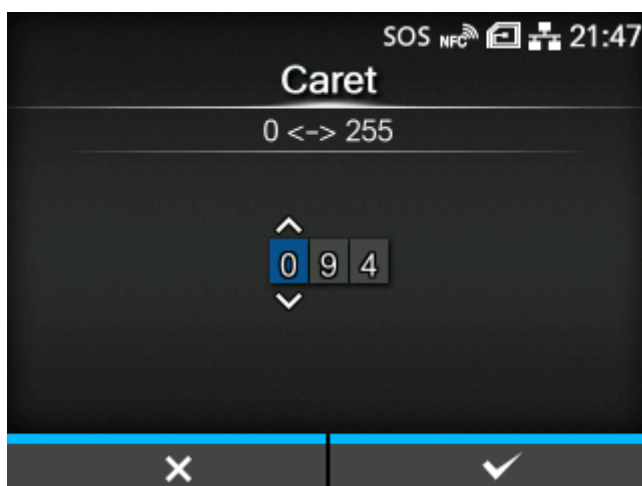

Set the caret (^) code.

The setting range is from 0 to 255.

[Delimiter]

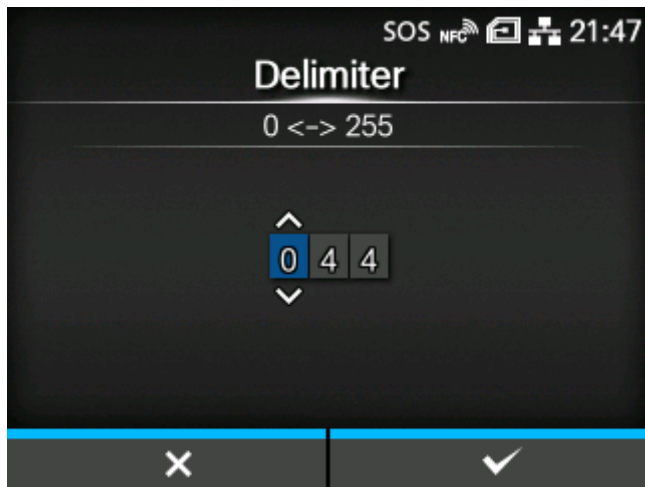

Set the delimiter (,) code.

The setting range is from 0 to 255.

[Tilde]

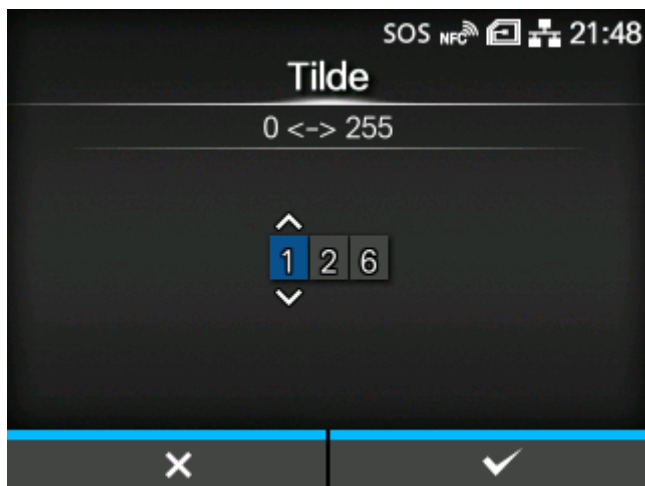

Set the tilde (~) code.

The setting range is from 0 to 255.

[Clock Format]

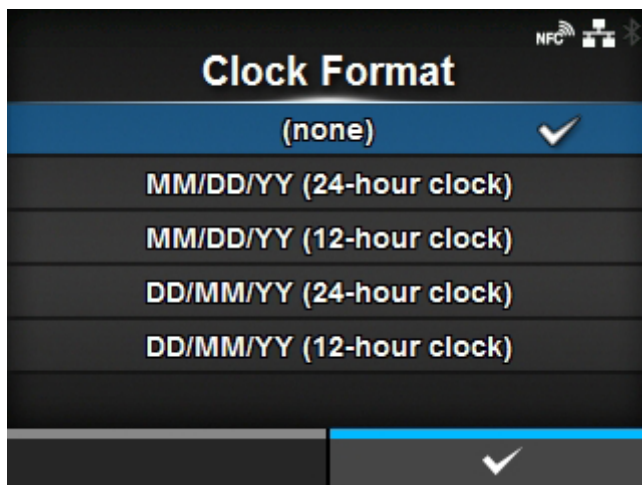

Set the date format.

The options are as follows (January 24, 2017, at 1:45 pm, for example):

- [(none)]
- [MM/DD/YY (24-hour clock)] (Example: 01/24/17 (13:45))
- [MM/DD/YY (12-hour clock)] (Example: 01/24/17 (01:45))
- [DD/MM/YY (24-hour clock)] (Example: 24/01/17 (13:45))
- [DD/MM/YY (12-hour clock)] (Example: 24/01/17 (01:45))

[Default Font]

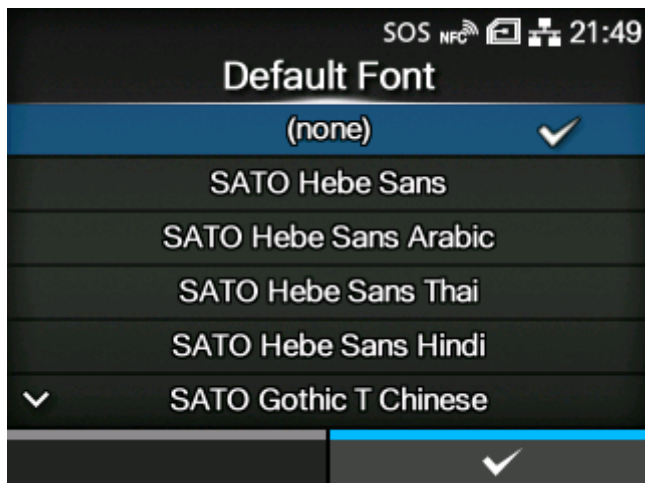

Select a default font from the list for when printing using a multilingual font contained in the product.

[SIPL]

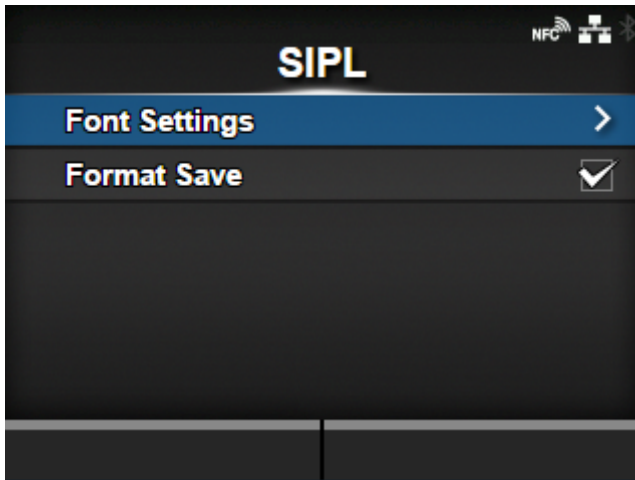

To use SIPL as a printer command, set the following items:

[Font Settings](#)

Set the font.

[Format Save](#)

Set whether to save the user format data registered at printing in the product.

[Font Settings]

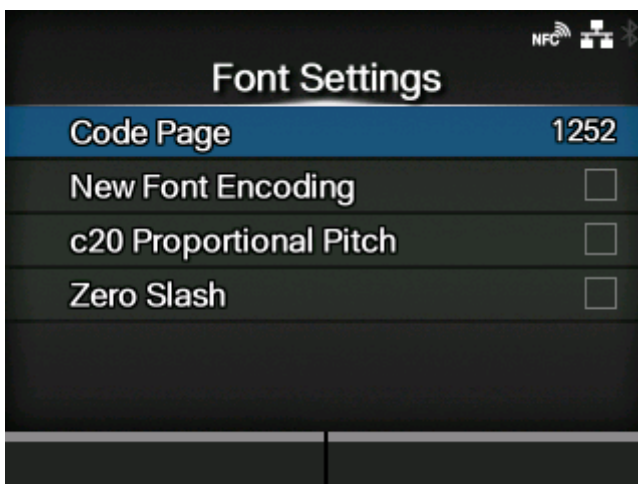

Set the font.

The setting items are as follows:

[Code Page](#)

Set the code page to be used.

[New Font Encoding](#)

Enable or disable new font encoding.

[c20 Proportional Pitch](#)

Set the character pitch for printing.

[Zero Slash](#)

Set the type for printing zero.

[Code Page]

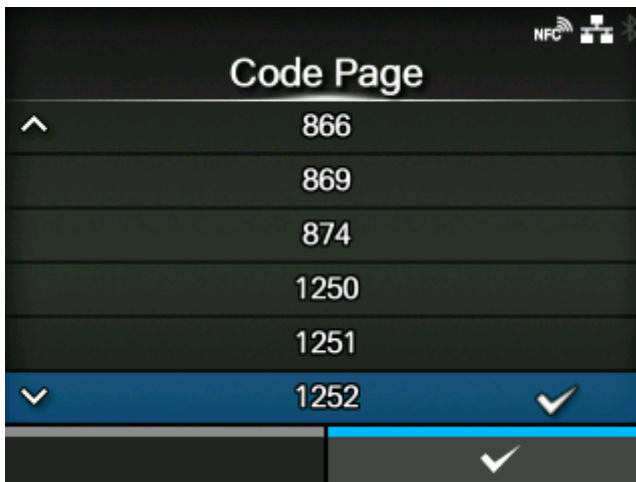

Select the code page to be used from the list.

[New Font Encoding]

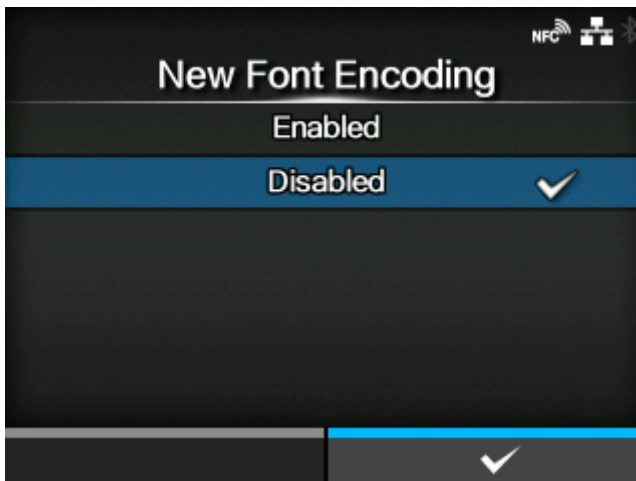

Enable or disable new font encoding.

The options are as follows:

Enabled

Enable new font encoding.

Disabled

Disable new font encoding.



- Contact your SATO sales representative for more information about the new font.

[c20 Proportional Pitch]

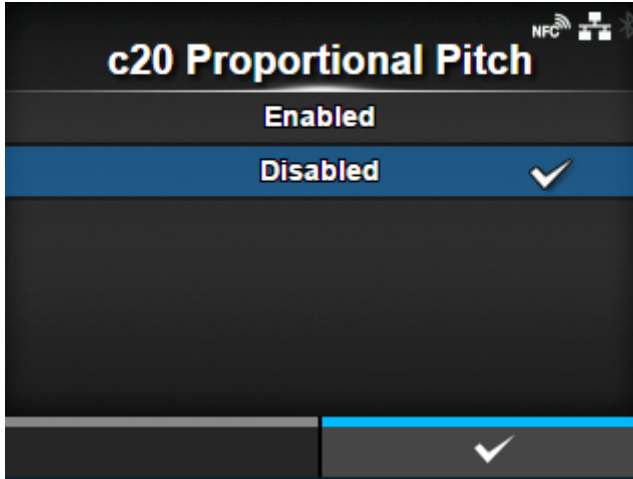

Set whether to print each character using a proportional pitch or fixed pitch.

The options are as follows:

Enabled

Print each character with a proportional pitch.

Disabled

Print all characters with a fixed pitch.

[Zero Slash]

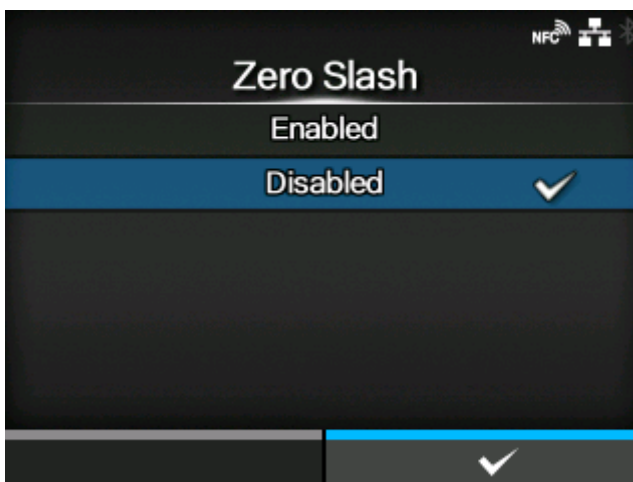

Set whether to print the number zero (0) with or without a slash (/).

The options are as follows:

Enabled

Print zero with a slash.

Disabled

Print zero without a slash.

[Format Save]

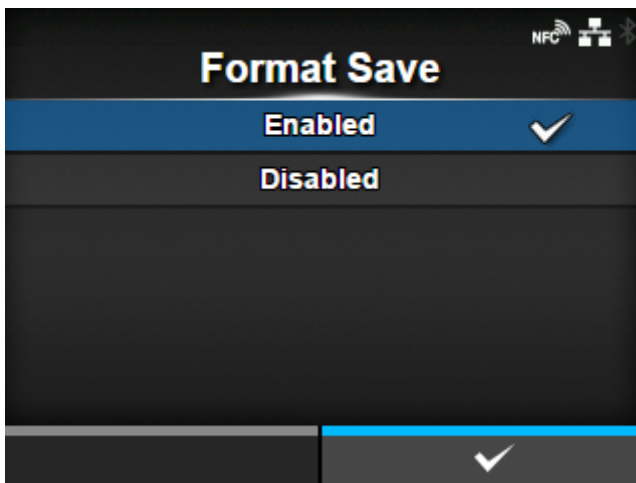

Set whether to save the user format data registered at printing in the product.

The options are as follows:

Enabled

Save the user format data registered at printing in the product.

Disabled

Do not save the user format data registered at printing in the product. The user format data remains in the product memory after printing until the product is powered off. You need to register a user format again after reboot.

[STCL]

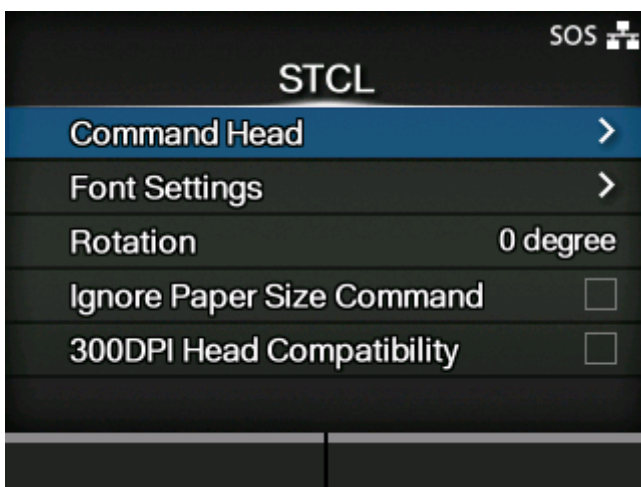

To use STCL as a printer command, set the following items:

[Command Head](#)

Set the command head.

[Font Settings](#)

Set the font.

[Rotation](#)

Set the page orientation for label printing.

[Ignore Paper Size Command](#)

Set whether to ignore a paper size command in the print data.

[300DPI Head Compatibility](#)

When you are using the product with 305 dpi resolution, enable or disable 300DPI Head Compatibility.

[Command Head]

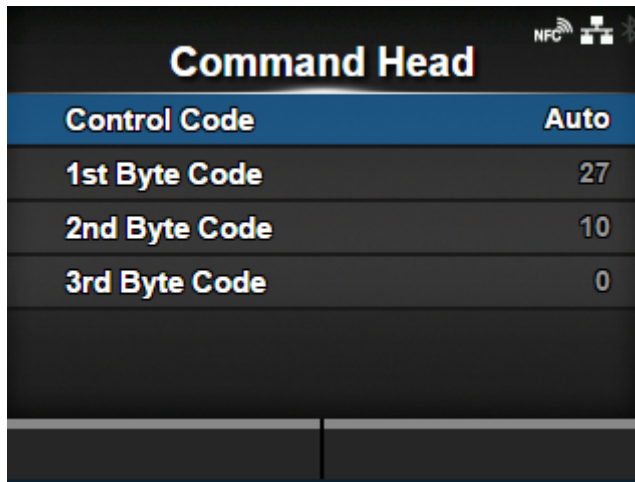

Command Head	
Control Code	Auto
1st Byte Code	27
2nd Byte Code	10
3rd Byte Code	0

Set the command head.

The setting items are as follows:

[Control Code](#)

Set the control code.

[1st Byte Code](#)

Set the first byte code.

[2nd Byte Code](#)

Set the second byte code.

[3rd Byte Code](#)

Set the third byte code.

[Control Code]

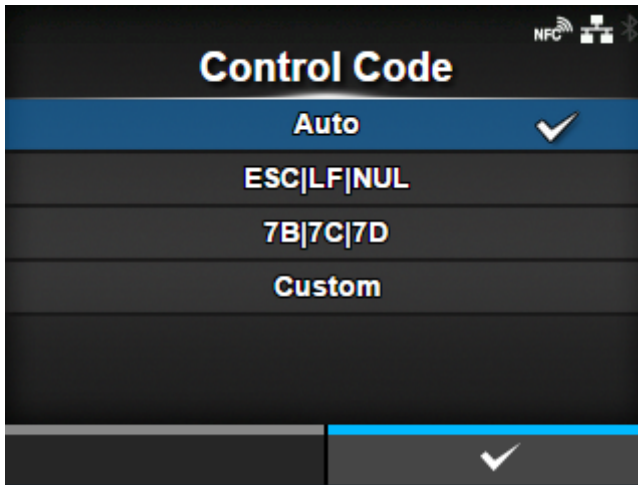

Set the control code.

The options are as follows:

Auto

Perform the protocol detection automatically.

ESC|LF|NUL

Set the control code to ESC|LF|NUL.

7B|7C|7D

Set the control code to 7B|7C|7D.

Custom

Change the first to third byte codes.

[1st Byte Code]

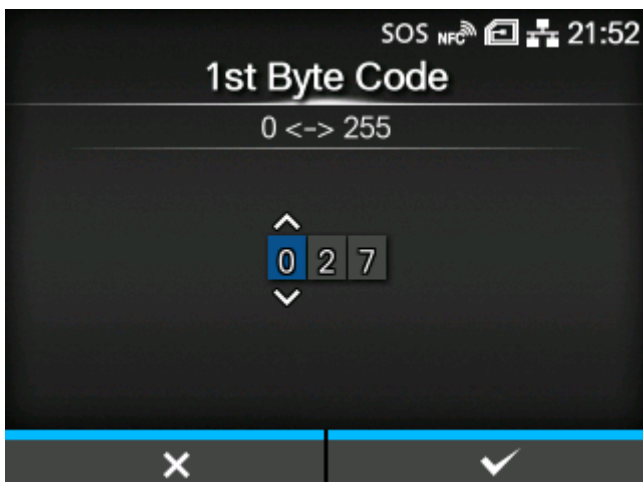

Set the first byte code.

You can change this only if you have selected [Custom] in the [Control Code] menu.

The setting range is from 0 to 255.

[2nd Byte Code]

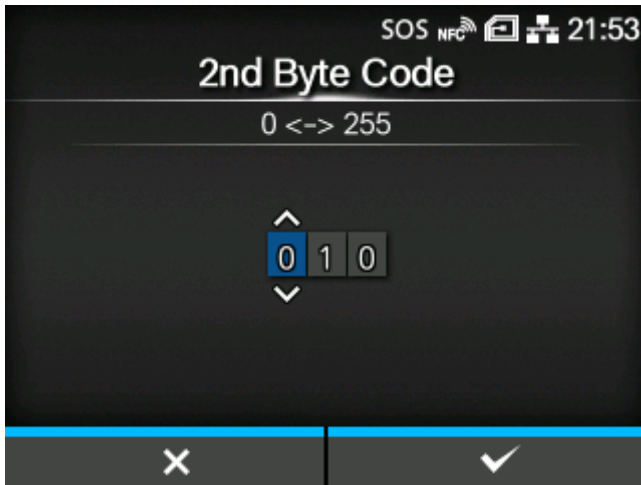

Set the second byte code.

You can change this only if you have selected [Custom] in the [Control Code] menu.

The setting range is from 0 to 255.

[3rd Byte Code]

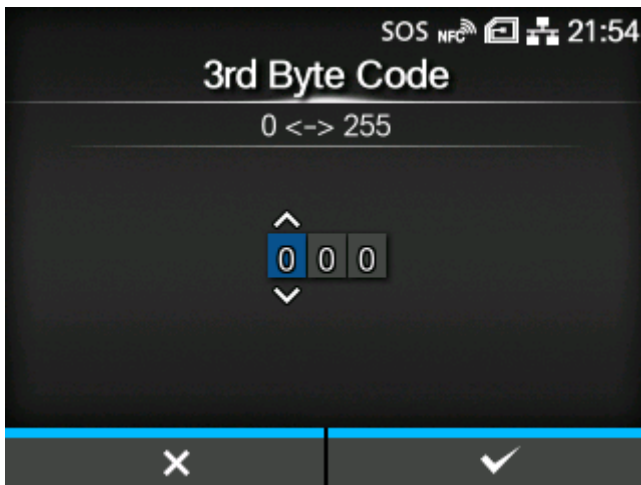

Set the third byte code.

You can change this only if you have selected [Custom] in the [Control Code] menu.

The setting range is from 0 to 255.

[Font Settings]

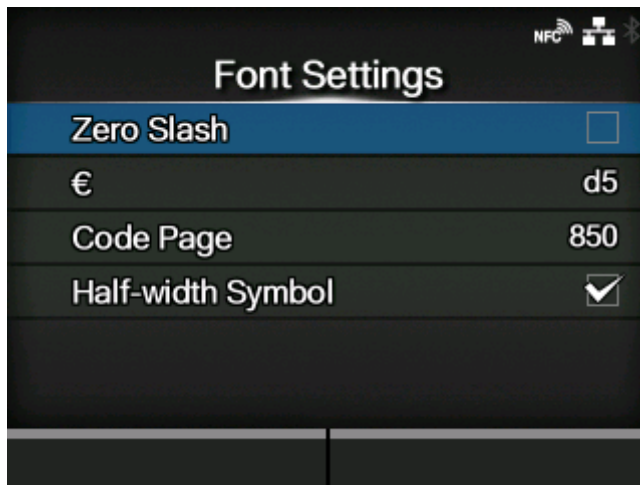

Set the font.

The setting items are as follows:

[Zero Slash](#)

Set the type for printing zero.

[€](#)

Set the European currency symbol to the ASCII code.

[Code Page](#)

Set the code page to be used.

[Half-width Symbol](#)

Set whether to print symbols with half-width characters.

[Zero Slash]

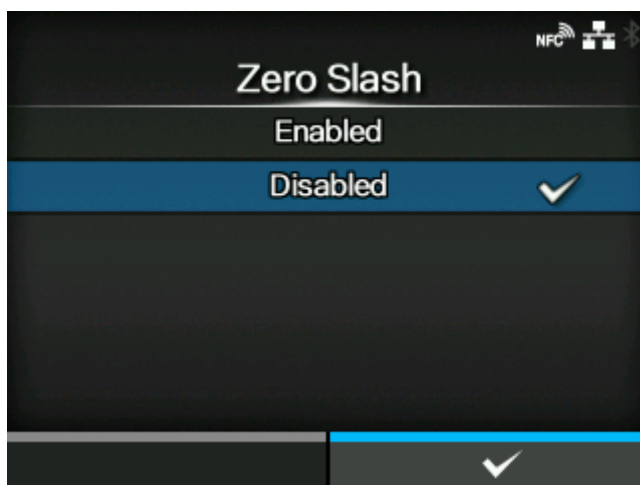

Set whether to print the number zero (0) with or without a slash (/).

The options are as follows:

Enabled

Print zero with a slash.

Disabled

Print zero without a slash.

[€]

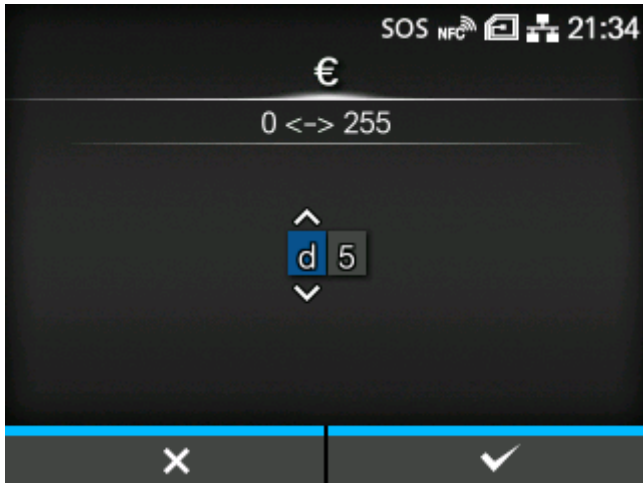

Set the European currency symbol to the ASCII code.

The setting range is from 00 to ff (hexadecimal).

[Code Page]

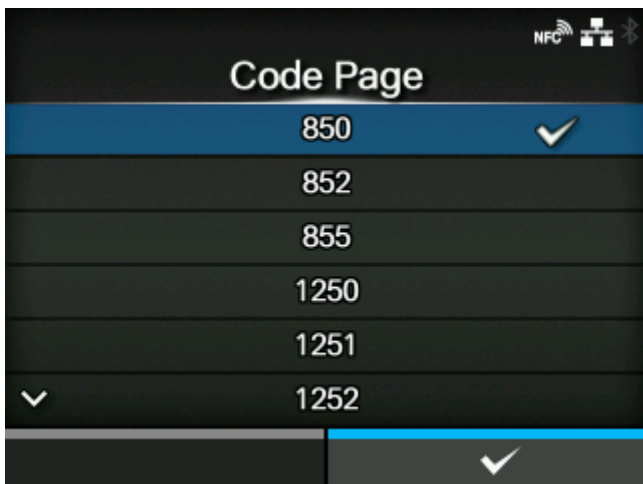

Select the code page to be used from the list.

[Half-width Symbol]

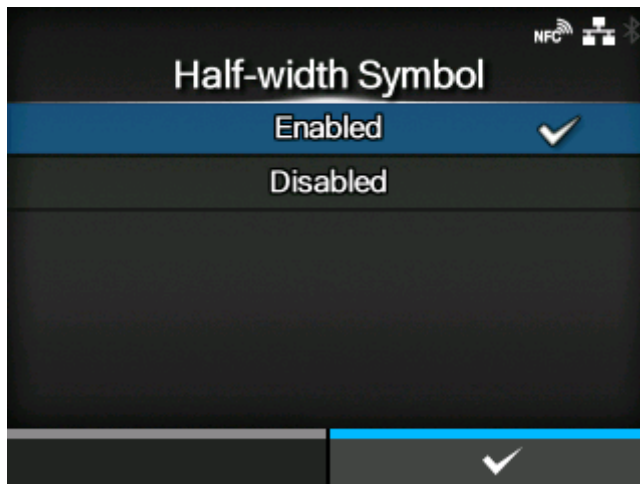

Set whether to print symbols with half-width characters.

The options are as follows:

Enabled

Print symbols with half-width characters.

Disabled

Do not print symbols with half-width characters.

[Rotation]

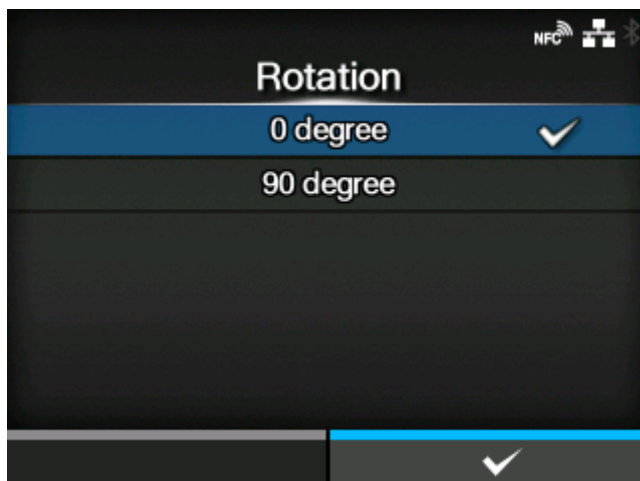

Set the page orientation for label printing.

The options are as follows:

0 degree

Labels are printed in portrait orientation.

90 degree

Labels are printed in landscape orientation.

[Ignore Paper Size Command]

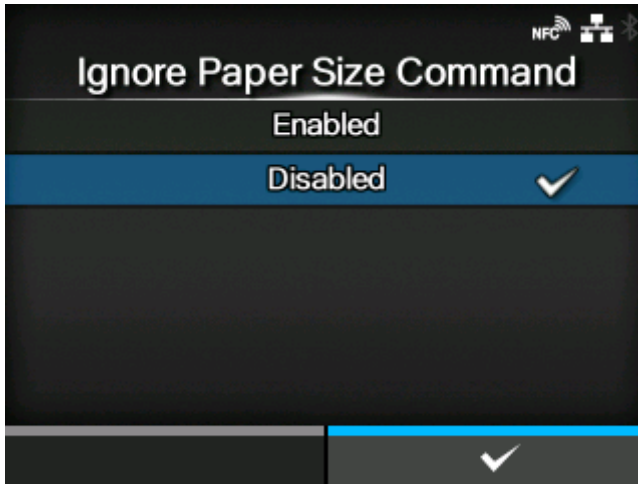

Set whether to ignore a paper size command in the print data.

The options are as follows:

Enabled

Ignore a paper size command in the print data.

Disabled

Do not ignore a paper size command in the print data.

[300DPI Head Compatibility]

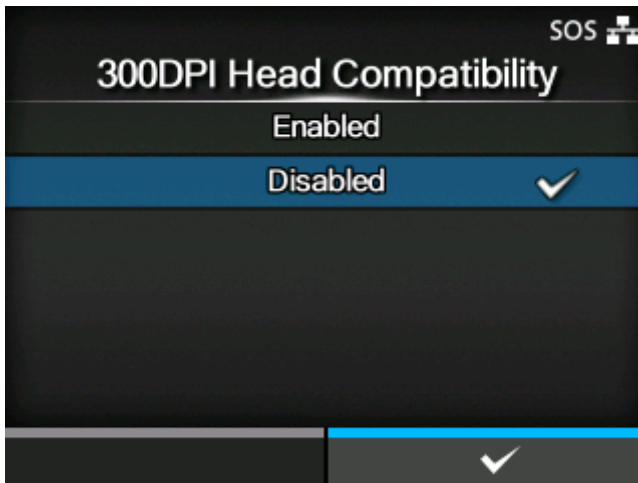

When you are using the product with 305 dpi resolution, enable or disable 300DPI Head Compatibility.

The options are as follows:

Enabled

Enable 300DPI Head Compatibility. Print data for a head density of 300 dpi is printed in 305 dpi.

Disabled

Disable 300DPI Head Compatibility.

[SDPL]

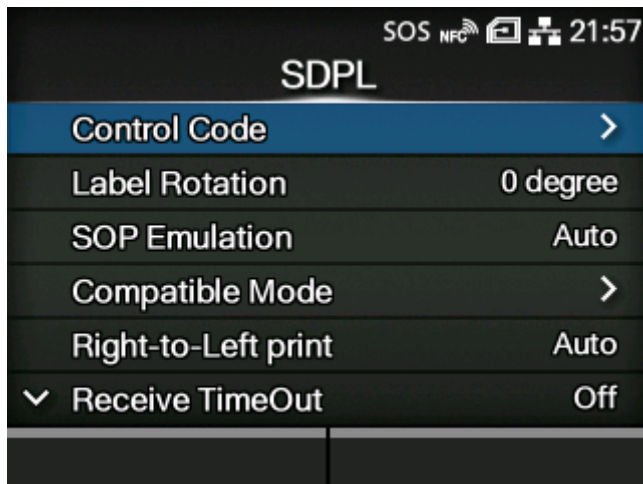

To use SDPL as a printer command, set the following items:

[Control Code](#)

Set the control code.

[Label Rotation](#)

Set the page orientation for label printing.

[SOP Emulation](#)

Set the SOP emulation.

[Compatible Mode](#)

Set the compatible mode for SDPL.

[Right-to-Left print](#)

Set the Right-to-Left printing function.

[Receive TimeOut](#)

Set a period of time the product stays in binary data receiving mode.

[Blank Item Feed](#)

Set whether to feed a label with nothing printed on it when the product receives label formatting commands that do not generate any printable image.

[Prioritize](#)

Select the settings to be prioritized for the SDPL command.

[Format Attribute](#)

Set the format attribute.

[Pause Mode](#)

Enable or disable the pause mode.

[1 Byte Codepage](#)

Select the code page to be used for one-byte characters.

[SDPL Measure Unit](#)

Set the measurement unit.

[Scalable Font Style](#)

Set the style of the scalable fonts.

[Feedback Character](#)

Enable or disable the <STX>a command.

[SOH Commands](#)

Set the SOH commands.

[Module Selection](#)

Select where to save the product settings.



- [Format Attribute], [Pause Mode], [1 Byte Codepage], [SDPL Measure Unit], [Scalable Font Style], [Feedback Character], [SOH Commands] and [Module Selection] are available only if [Settings] is selected for the corresponding setting item under the [Prioritize] menu.
-

[\[Control Code\]](#)

Code Type	Standard
SOH	01
STX	02
CR	0D
CNTBY	5E

Set the control code.

The setting items are as follows:

[Code Type](#)

Set the type of the control code.

[SOH](#)

Set the SOH code.

[STX](#)

Set the STX code.

[CR](#)

Set the CR code.

[CNTBY](#)

Set the CNTBY code.

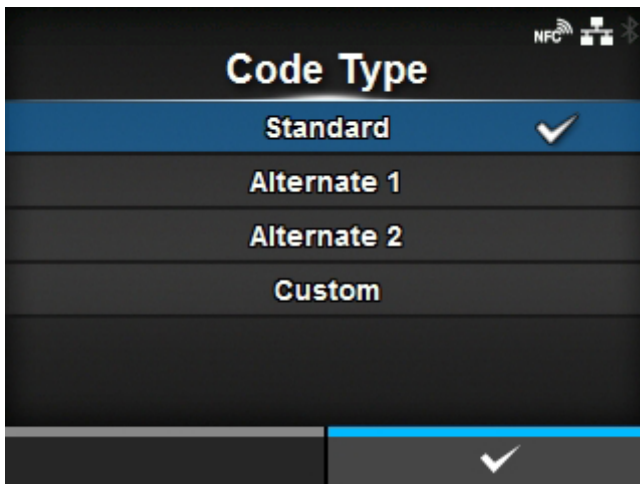
[Code Type]

Set the type of the control code.

The options are as follows:

- [Standard]
- [Alternate 1]
- [Alternate 2]
- [Custom]

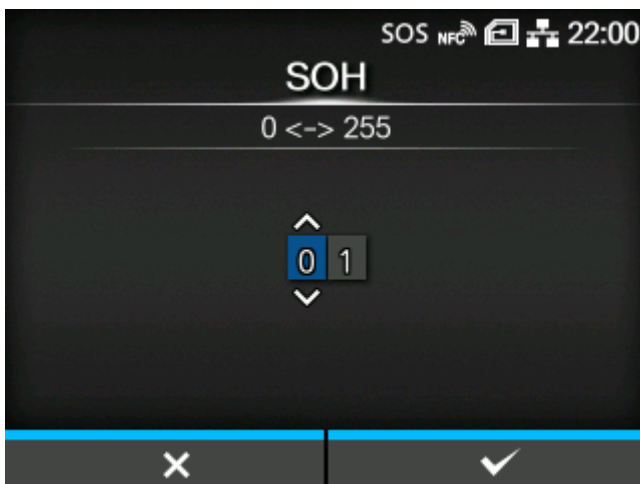
[SOH]

Set the SOH code.

You can change this if you have selected [Custom] in the [Code Type] menu.

The setting range is from 00 to ff (hexadecimal).

[STX]

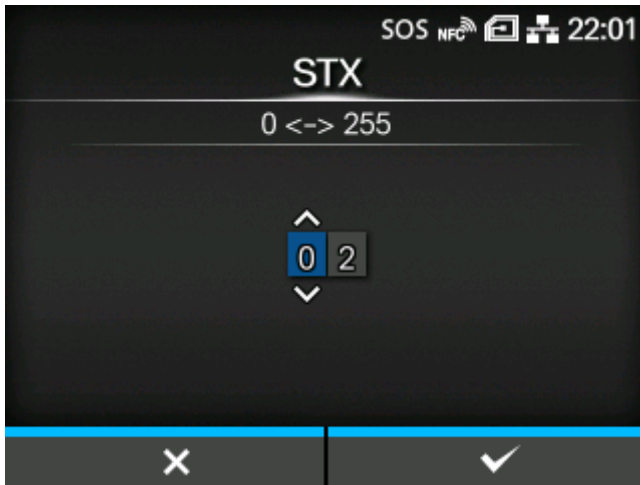

Set the STX code.

You can change this if you have selected [Custom] in the [Code Type] menu.

The setting range is from 00 to ff (hexadecimal).

[CR]

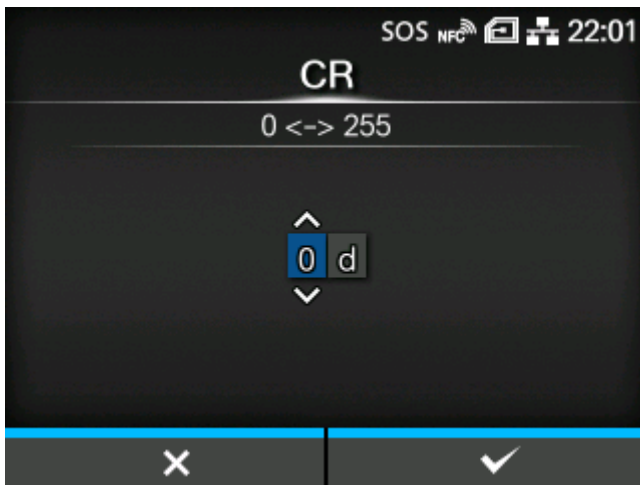

Set the CR code.

You can change this if you have selected [Custom] in the [Code Type] menu.

The setting range is from 00 to ff (hexadecimal).

[CNTBY]

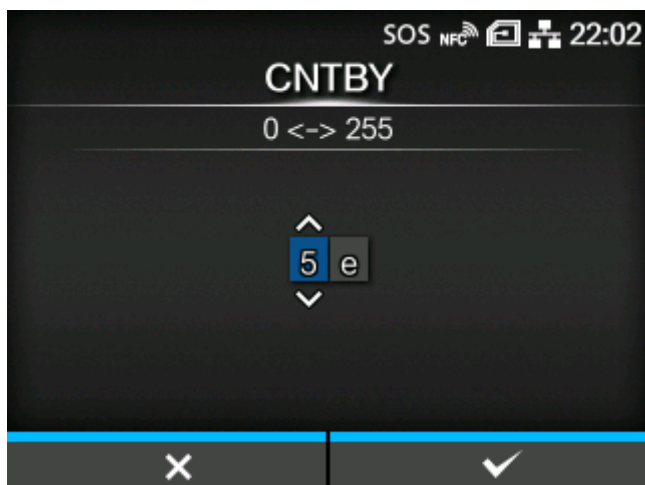

Set the CNTBY code.

You can change this if you have selected [Custom] in the [Code Type] menu.

The setting range is from 00 to ff (hexadecimal).

[Label Rotation]

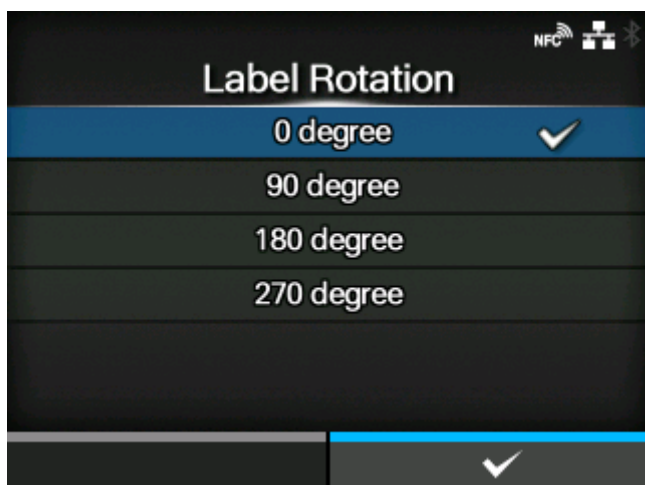

Set the page orientation for label printing.

The label size set in the product is used as a reference for rotation.

The options are as follows:

0 degree

Labels are printed in a portrait orientation.

90 degree

Labels are printed in a landscape orientation.

180 degree

Labels are printed in an inverse-portrait orientation.

270 degree

Labels are printed in an inverse-landscape orientation.

[SOP Emulation]

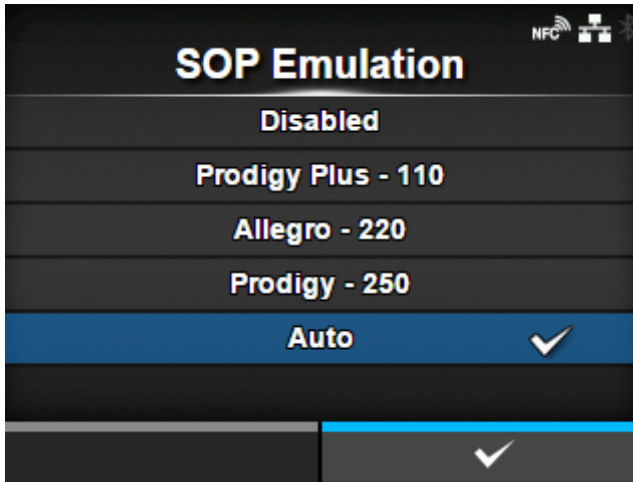

Set the SOP emulation.

The options are as follows:

- [Disabled]
- [Prodigy Plus - 110]
- [Allegro - 220]
- [Prodigy - 250]
- [Auto]

[Compatible Mode]

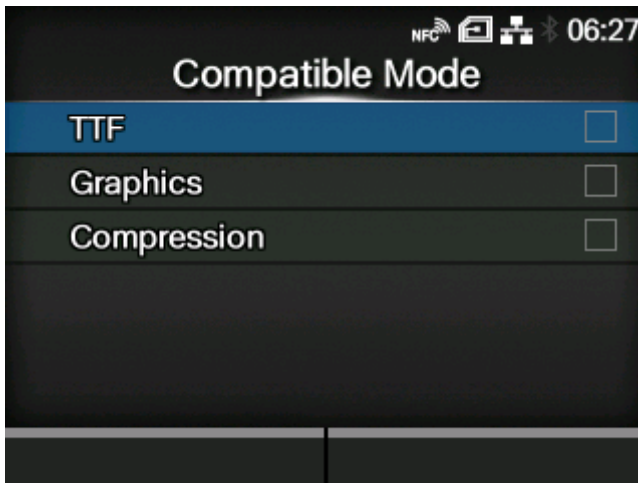

Set the compatible mode for SDPL.

The setting items are as follows:

[TTF](#)

Enable or disable TrueType font compatible mode.

[Graphics](#)

Set whether to allow the registration of graphic data even if a line feed code is omitted.

[Compression](#)

Set whether to accept graphic data created by a unique compression method.

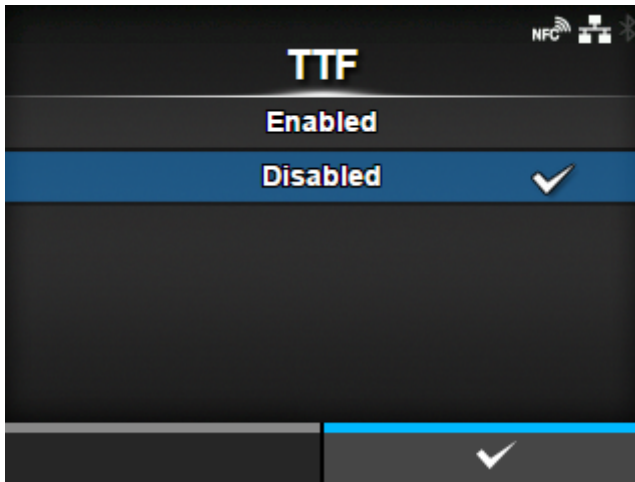
[TTF]

Enable or disable TrueType font compatible mode.

The options are as follows:

Enabled

Enable TrueType font compatible mode. The bold TrueType fonts are printed in smaller pitch.

Disabled

Disable TrueType font compatible mode.

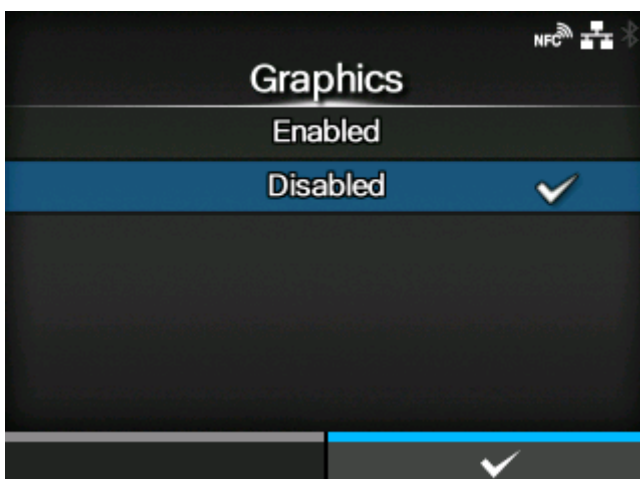
[Graphics]

Set whether to allow the registration of graphic data even if a line feed code is omitted.

The options are as follows:

Enabled

Allow the registration of graphic data even when a line feed code is omitted.

Disabled

Do not allow the registration of graphic data when a line feed code is omitted.

[Compression]

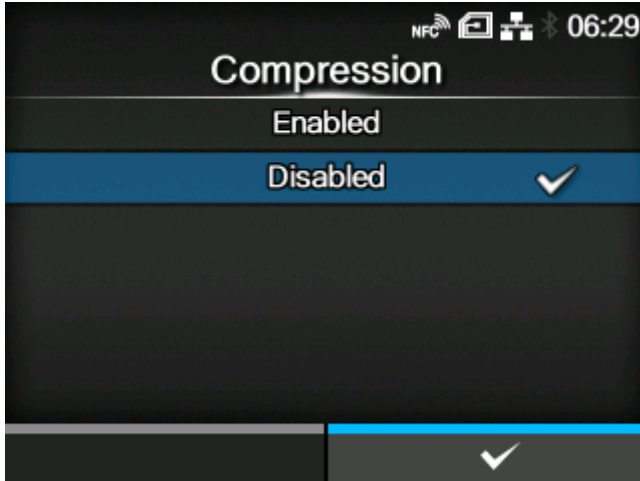

Set whether to accept graphic data created by a unique compression method.

The options are as follows:

Enabled

Accepts graphic data created by a unique compression method.

Disabled

Does not accept graphic data created by a unique compression method.

[Right-to-Left print]

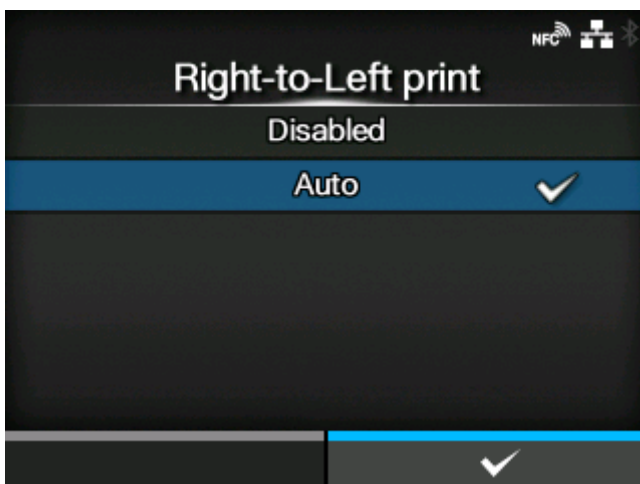

Set the Right-to-Left printing function.

The options are as follows:

Disabled

All texts are printed from left to right.

Auto

When an Arabic font is detected, the Arabic text is printed from right to left.

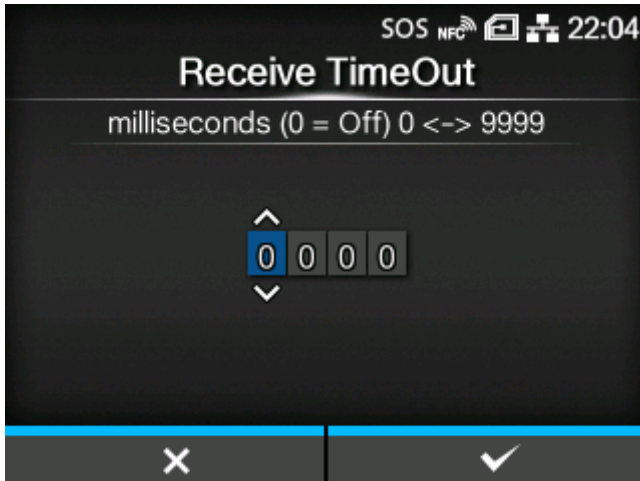
[Receive TimeOut]

Set a period of time the product stays in binary data receiving mode.

When the specified period of time passes, the product exits from binary receiving mode and scans for SDPL commands.

The setting range is from 0 (off) to 9999 ms.

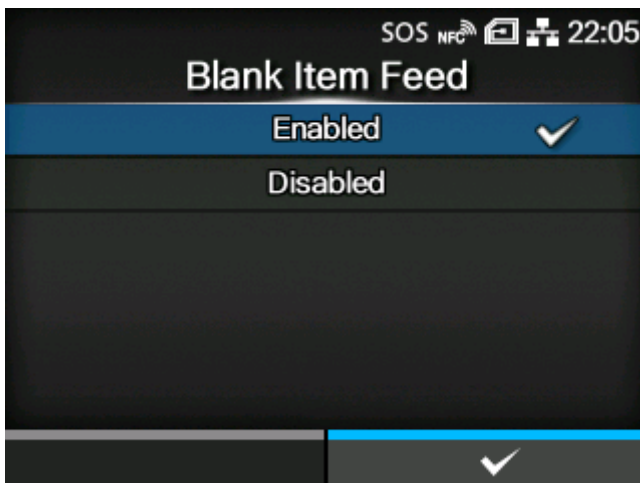
[Blank Item Feed]

Set whether to feed a label with nothing printed on it when the product receives label formatting commands that do not generate any printable image.

The options are as follows:

Enabled

Feeds a label with nothing printed on it.

Disabled

Does not feed a label with nothing printed on it.

[Prioritize]

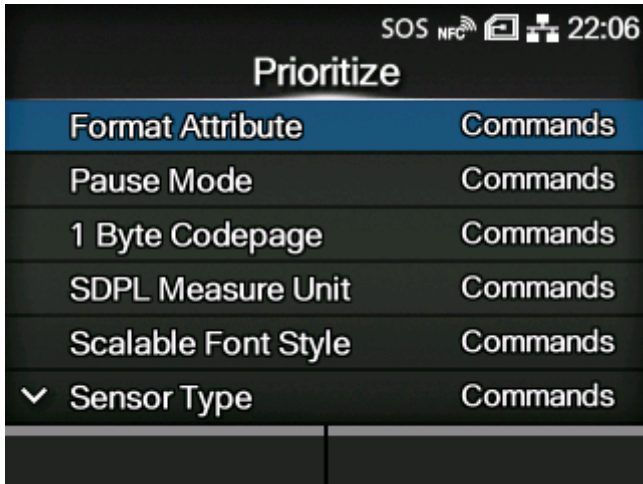

Prioritize	
Format Attribute	Commands
Pause Mode	Commands
1 Byte Codepage	Commands
SDPL Measure Unit	Commands
Scalable Font Style	Commands
✓ Sensor Type	Commands

Select the settings to be prioritized for each setting item of the SDPL command. You can set whether to prioritize settings that are done through the product or through commands.

When you select [Settings] for an item, the setting specified in the [SDPL] menu of the product will be used.

The setting items are as follows:

[Format Attribute](#)

Select the setting to be prioritized for the format attribute.

[Pause Mode](#)

Select the setting to be prioritized for pause mode.

[1 Byte Codepage](#)

Select the setting to be prioritized for the 1 byte code page.

[SDPL Measure Unit](#)

Select the setting to be prioritized for the measurement unit.

[Scalable Font Style](#)

Select the setting to be prioritized for the scalable font style.

[Sensor Type](#)

Select the setting to be prioritized for the sensor type.

[Feedback Character](#)

Select the setting to be prioritized for the feedback character.

[SOH Commands](#)

Select the setting to be prioritized for the SOH commands.

[Module Selection](#)

Select the setting to be prioritized for the module selection.

[Darkness](#)

[Factory Offset](#)

Speed

The option selected in the [Printing] > [Advanced] > [Prioritize] menu is applied to these three settings and shown on this screen.

[Format Attribute]

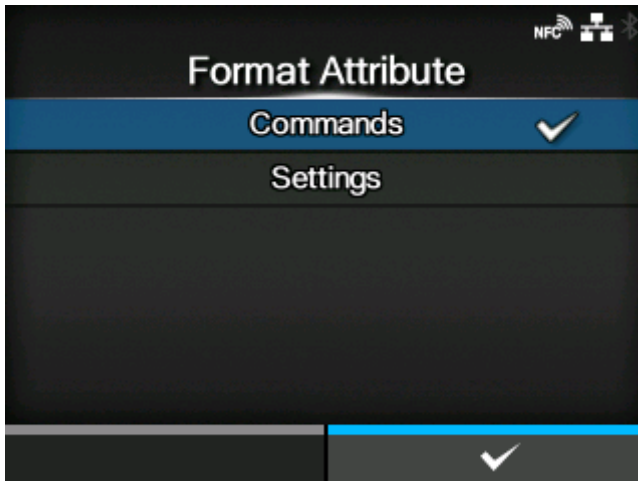

Set whether to prioritize the settings that are done through the product or through commands for the format attribute setting.

The options are as follows:

Commands

Prioritize the settings through commands.

Settings

Prioritize the settings that are done through the product.

[Pause Mode]

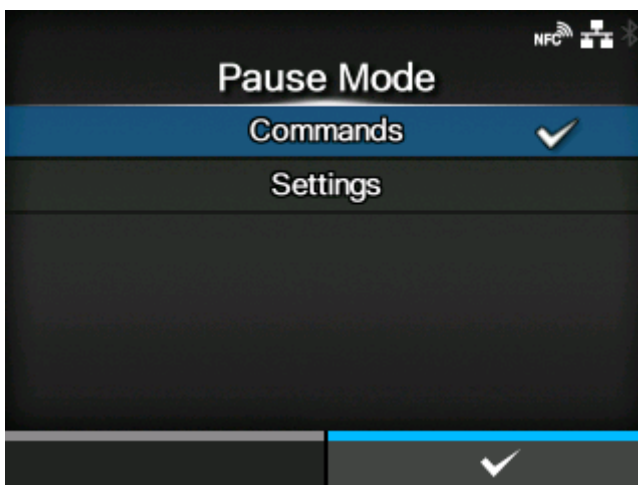

Set whether to prioritize the settings that are done through the product or through commands for the pause mode setting.

The options are as follows:

Commands

Prioritize the settings through commands.

Settings

Prioritize the settings that are done through the product.

[1 Byte Codepage]

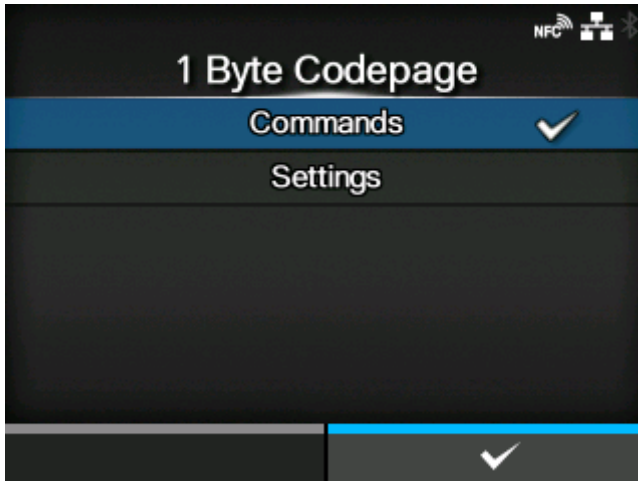

Set whether to prioritize the settings that are done through the product or through commands for the 1 byte code page setting.

The options are as follows:

Commands

Prioritize the settings through commands.

Settings

Prioritize the settings that are done through the product.

[SDPL Measure Unit]

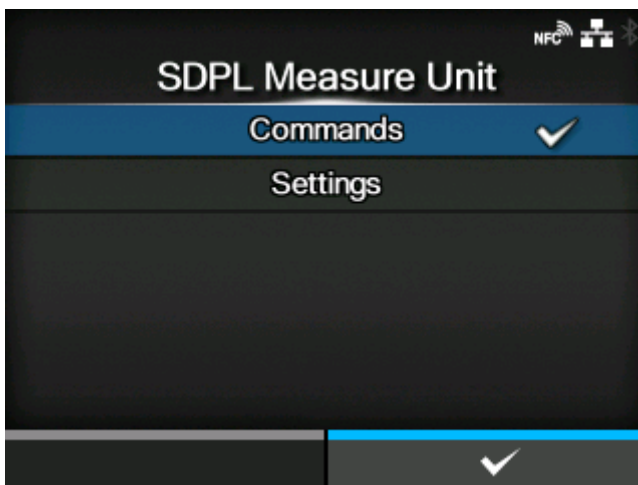

Set whether to prioritize the settings that are done through the product or through commands for the measurement unit setting.

The options are as follows:

Commands

Prioritize the settings through commands.

Settings

Prioritize the settings that are done through the product.

[Scalable Font Style]

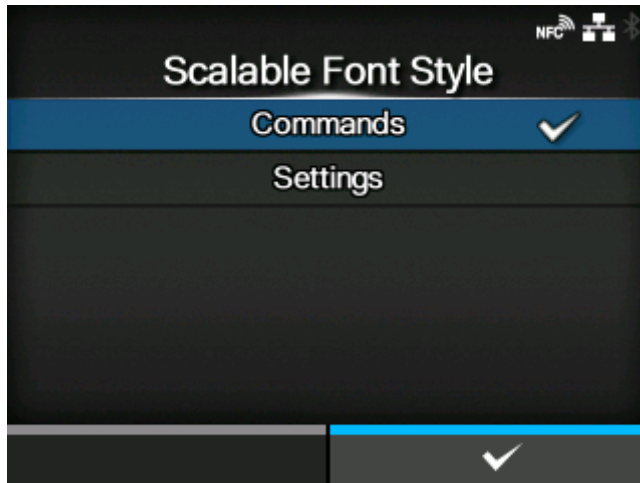

Set whether to prioritize the settings that are done through the product or through commands for the scalable font style settings.

The options are as follows:

Commands

Prioritize the settings through commands.

Settings

Prioritize the settings that are done through the product.

[Sensor Type]

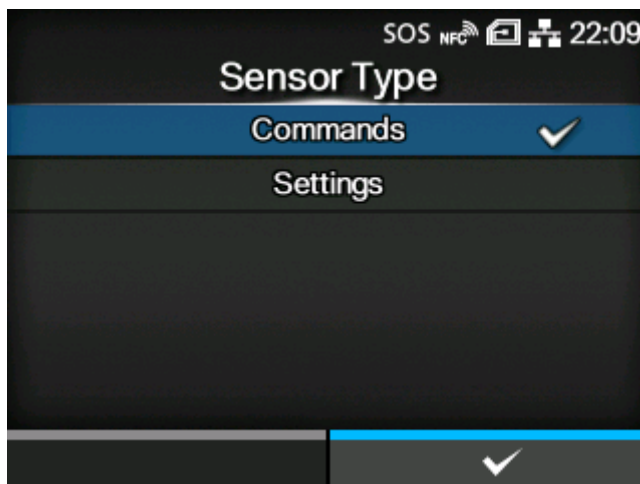

Set whether to prioritize the settings that are done through the product or through commands for the sensor type setting.

The options are as follows:

Commands

Prioritize the settings through commands.

Settings

Prioritize the settings that are done through the product.

[Feedback Character]

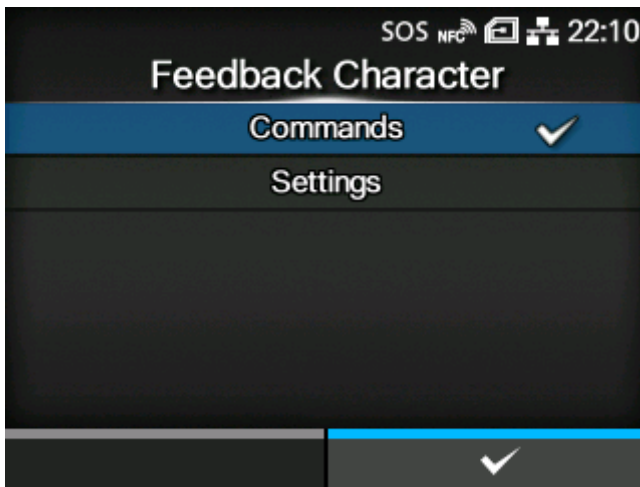

Set whether to prioritize the settings that are done through the product or through commands for the feedback character setting.

The options are as follows:

Commands

Prioritize the settings through commands.

Settings

Prioritize the settings that are done through the product.

[SOH Commands]

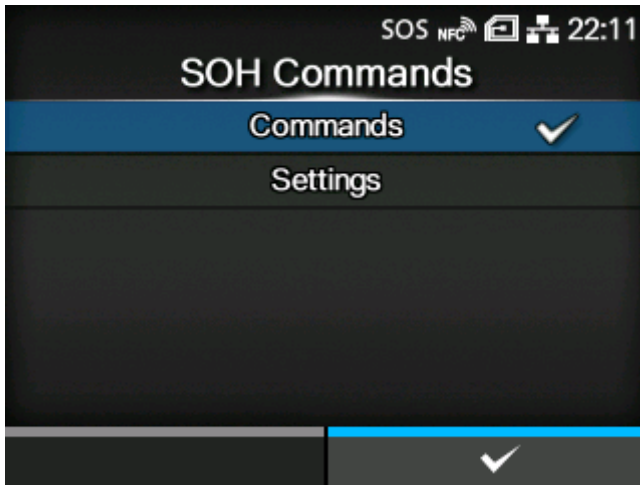

Set whether to prioritize the settings that are done through the product or through commands for the SOH Commands settings.

The options are as follows:

Commands

Prioritize the settings through commands.

Settings

Prioritize the settings that are done through the product.

[Module Selection]

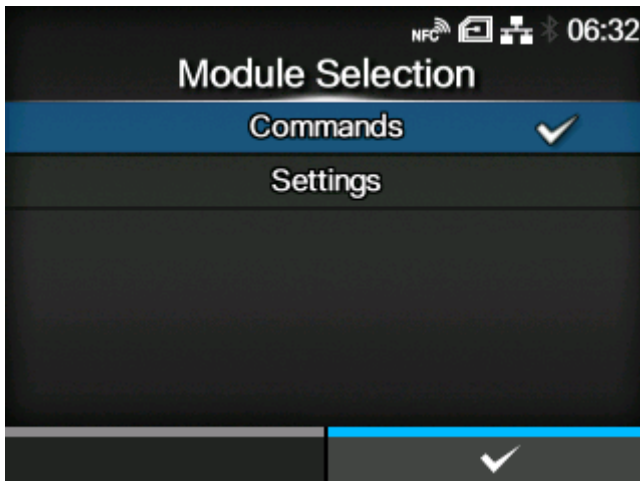

Set whether to prioritize the settings that are done through the product or through commands for the module selection setting.

The options are as follows:

Commands

Prioritize the settings through commands.

Settings

Prioritize the settings that are done through the product.



- Even if you select [Commands], the settings that are done through the product are used if no command is sent.

[Format Attribute]

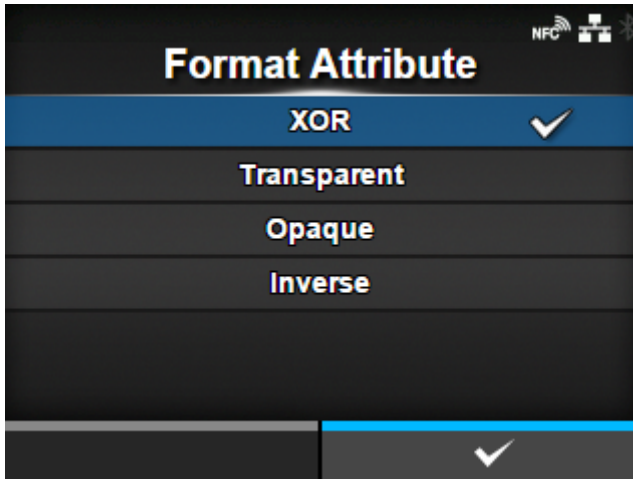

Set the format attribute.

You can change this setting if you have selected [Settings] in the [Prioritize] > [Format Attribute] menu.

The options are as follows:

- [XOR]
- [Transparent]
- [Opaque]
- [Inverse]

[Pause Mode]

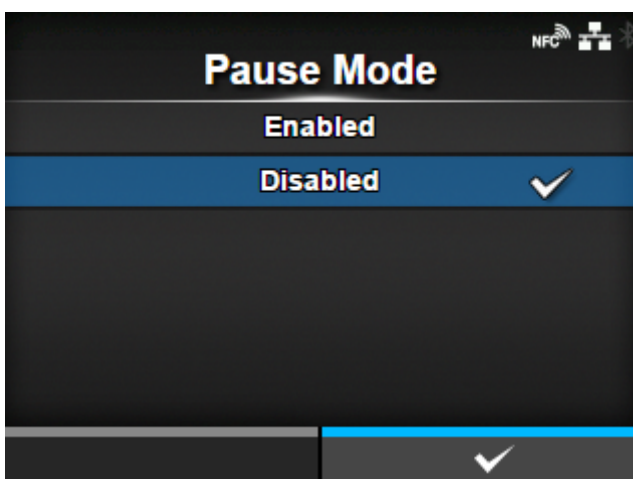

Enable or disable the pause mode.

You can change this setting if you have selected [Settings] in the [Prioritize] > [Pause Mode] menu.

The options are as follows:

Enabled

Enable the pause mode.

Disabled

Disable the pause mode.

[1 Byte Codepage]

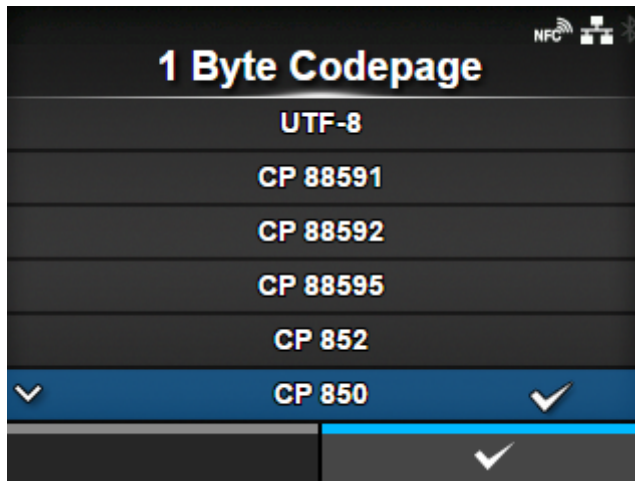

Select the code page to be used for one-byte characters from the list.

You can change this setting if you have selected [Settings] in the [Prioritize] > [1 Byte Codepage] menu.

[SDPL Measure Unit]

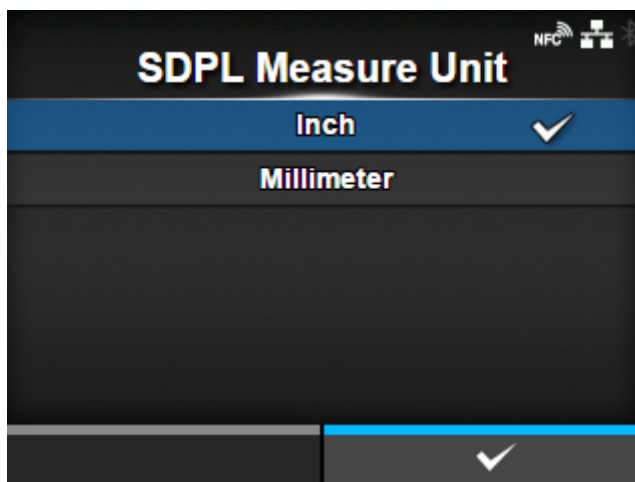

Set the measurement unit.

You can change this setting if you have selected [Settings] in the [Prioritize] > [SDPL Measure Unit] menu.

The options are as follows:

- [Inch]
- [Millimeter]

[Scalable Font Style]

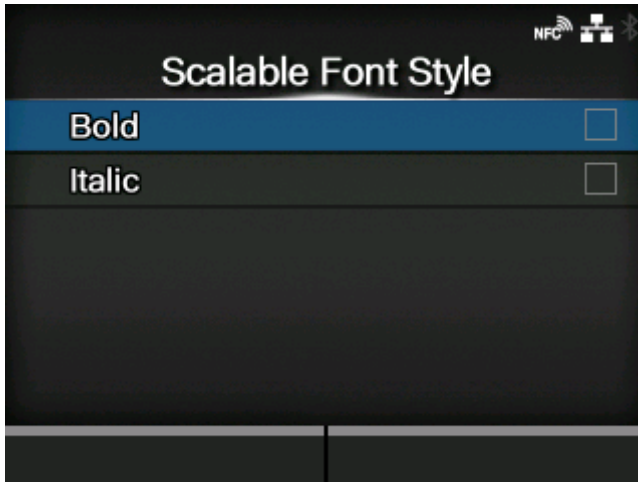

Set the style of the scalable fonts.

You can change this setting if you have selected [Settings] in the [Prioritize] > [Scalable Font Style] menu.

The setting items are as follows:

[Bold](#)

Set whether to use bold.

[Italic](#)

Set whether to use italics.

[Bold]

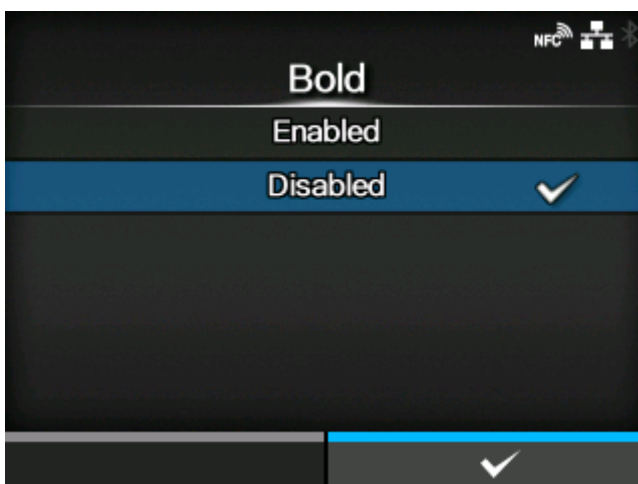

Set whether to use bold for the scalable fonts.

The options are as follows:

[Enabled](#)

Use bold.

Disabled

Do not use bold.

[Italic]

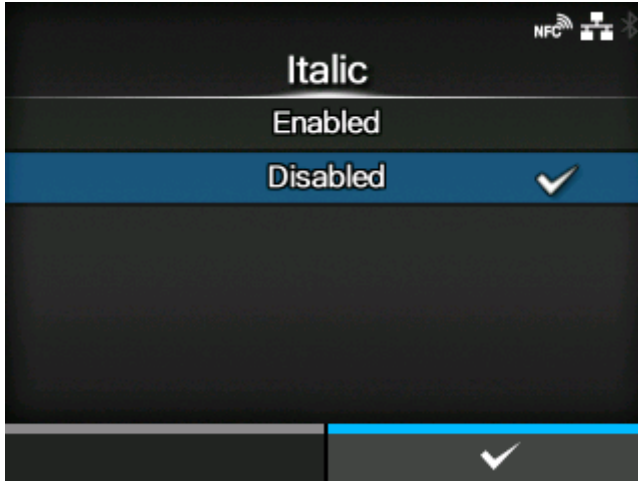

Set whether to use italics for the scalable fonts.

The options are as follows:

Enabled

Use italics.

Disabled

Do not use italics.

[Feedback Character]

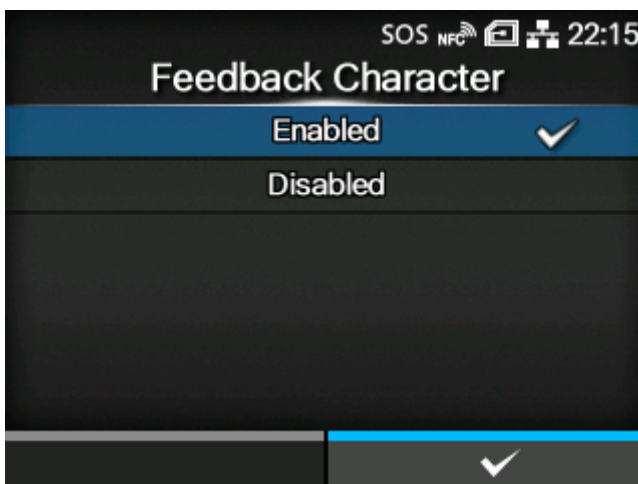

Enable or disable the <STX>a command.

You can change this setting if you have selected [Settings] in the [Prioritize] > [Feedback Character] menu.

The options are as follows:

Enabled

Enable the <STX>a command.

Disabled

Disable the <STX>a command.

[SOH Commands]



Set the SOH commands.

You can change this setting if you have selected [Settings] in the [Prioritize] > [SOH Commands] menu.

The setting items are as follows:

All Commands

Enable or disable all the SOH commands. You can also select to set each command individually.

SOH-B Command

Enable or disable the SOH-B command.

- Available only if you have selected [Custom] in the [All Commands] menu.

SOH-C Command

Enable or disable the SOH-C command.

- Available only if you have selected [Custom] in the [All Commands] menu.

Others

Enable or disable the SOH commands other than the SOH-B and SOH-C commands.

- Available only if you have selected [Custom] in the [All Commands] menu.

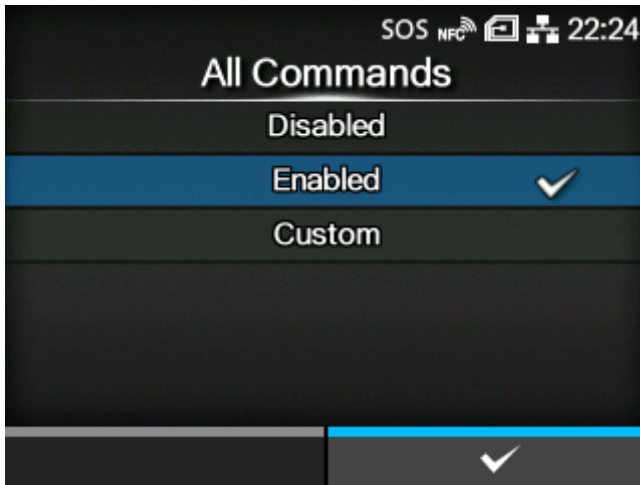
[All Commands]

Enable or disable all the SOH commands. You can also select to set each command individually.

The options are as follows:

Disabled

Disable all the SOH commands.

Enabled

Enable all the SOH commands.

Custom

Enable or disable each type of the SOH commands individually.

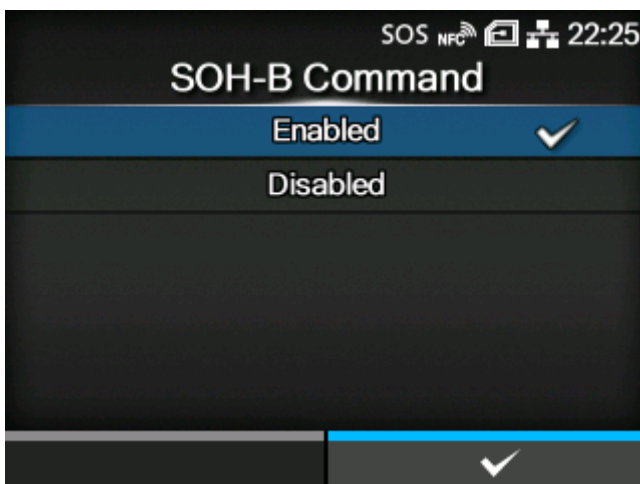
[SOH-B Command]

Enable or disable the SOH-B command.

Available if you have selected [Custom] in the [All Commands] menu.

The options are as follows:

Enabled

Enable the SOH-B command.

Disabled

Disable the SOH-B command.

[SOH-C Command]

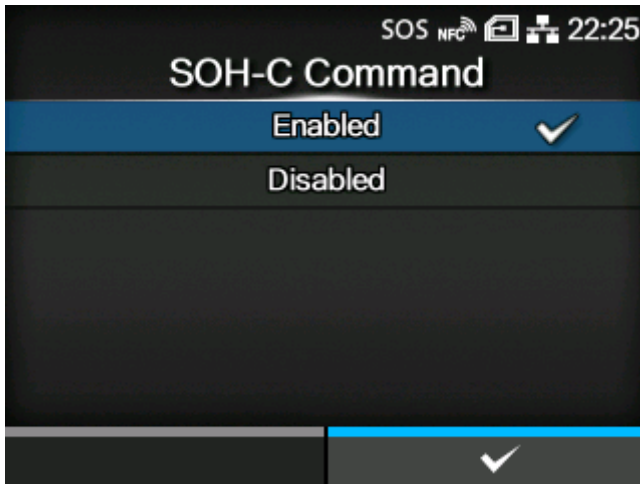

Enable or disable the SOH-C command.

Available if you have selected [Custom] in the [All Commands] menu.

The options are as follows:

Enabled

Enable the SOH-C command.

Disabled

Disable the SOH-C command.

[Others]

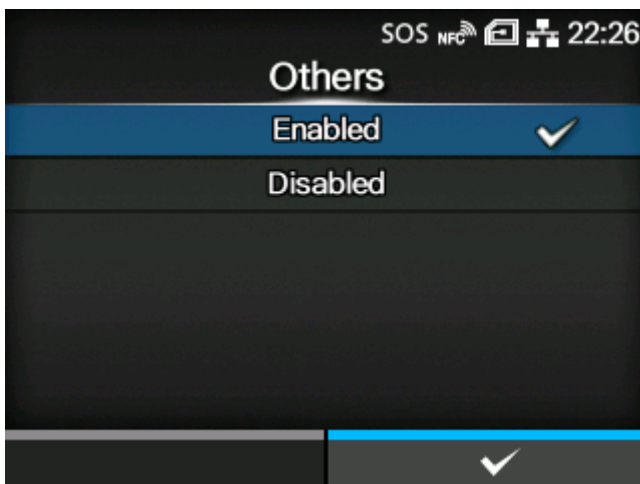

Enable or disable the SOH commands other than the SOH-B and SOH-C commands.

Available if you have selected [Custom] in the [All Commands] menu.

The options are as follows:

Enabled

Enable the SOH commands other than the SOH-B and SOH-C commands.

Disabled

Disable the SOH commands other than the SOH-B and SOH-C commands.

[Module Selection]

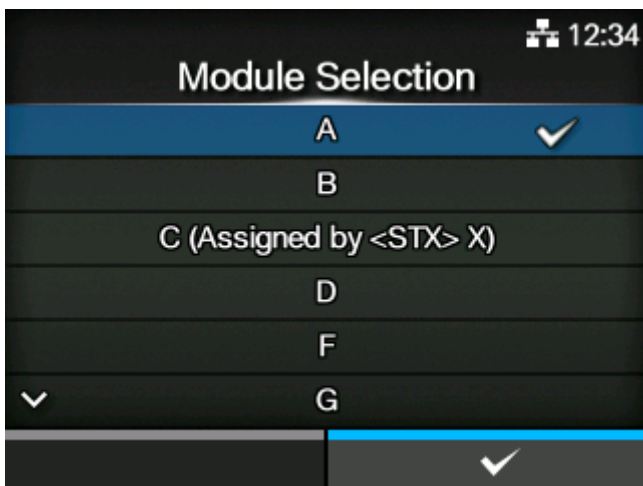

Select where to save the product settings.

You can change this setting if you have selected [Settings] in the [Prioritize] > [Module Selection] menu.

You can select from A, B, C (Assigned by <STX> X), D, F, G, H, I, J, X, Y, and Z.

[SEPL]

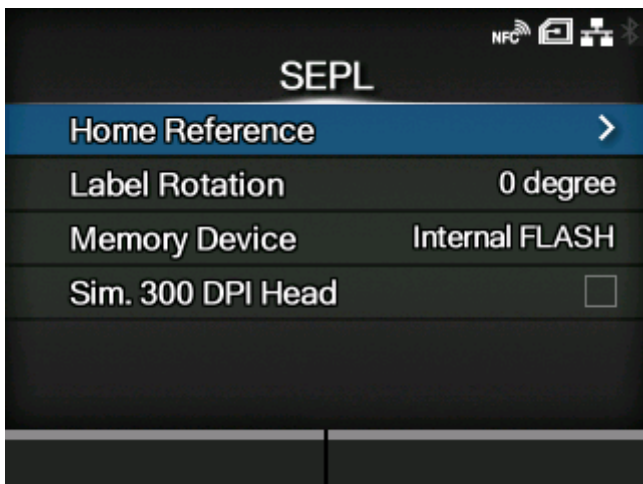

To use SEPL as a printer command, set the following items:

Home Reference

Adjust the print reference position by specifying the offset position in the horizontal and vertical directions.

[Label Rotation](#)

Set the page orientation for label printing.

[Memory Device](#)

Select the product's memory space in which to store forms, graphics and fonts.

[Sim. 300 DPI Head](#)

When you are using the product with 305 dpi resolution, enable or disable 300 dpi simulation mode.

[\[Home Reference\]](#)

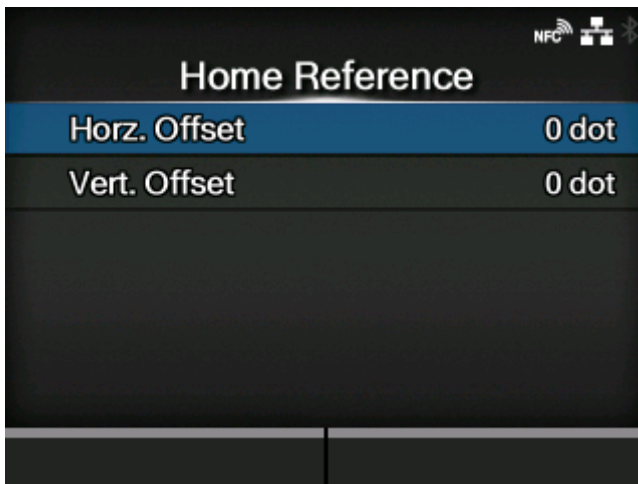

Adjust the print reference position by specifying the offset position in the horizontal and vertical directions.

The setting items are as follows:

[Horz. Offset](#)

Specify the offset position in the horizontal direction.

[Vert. Offset](#)

Specify the offset position in the vertical direction.

[Horz. Offset]



Specify the offset position in the horizontal direction.

The setting range is from 0 to 400 dots.



- The length of 1 dot varies depending on the print resolution of the product.
 - 203 dpi : 1 dot = 0.125 mm (0.0049")
 - 305 dpi : 1 dot = 0.083 mm (0.0033")
 - 609 dpi : 1 dot = 0.042 mm (0.0017")

[Vert. Offset]

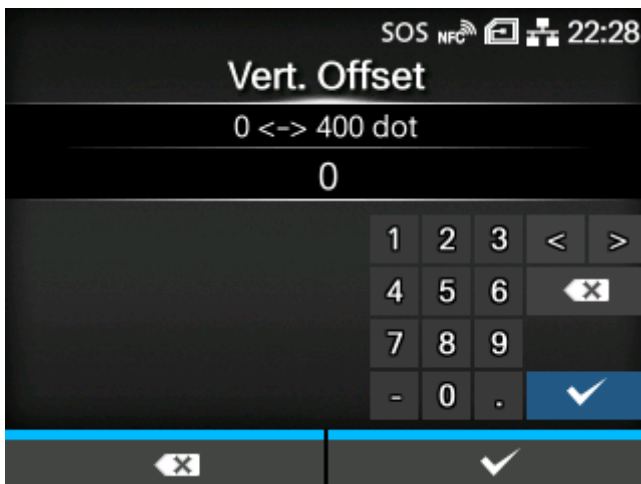

Specify the offset position in the vertical direction.

The setting range is from 0 to 400 dots.



- The length of 1 dot varies depending on the print resolution of the product.
 - 203 dpi : 1 dot = 0.125 mm (0.0049")
 - 305 dpi : 1 dot = 0.083 mm (0.0033")
 - 609 dpi : 1 dot = 0.042 mm (0.0017")

[Label Rotation]



Set the page orientation for label printing.

The label size set in the product is used as a reference for rotation.

The options are as follows:

0 degree

Labels are printed in a portrait orientation.

180 degree

Labels are printed in an inverse-portrait orientation.

[Memory Device]

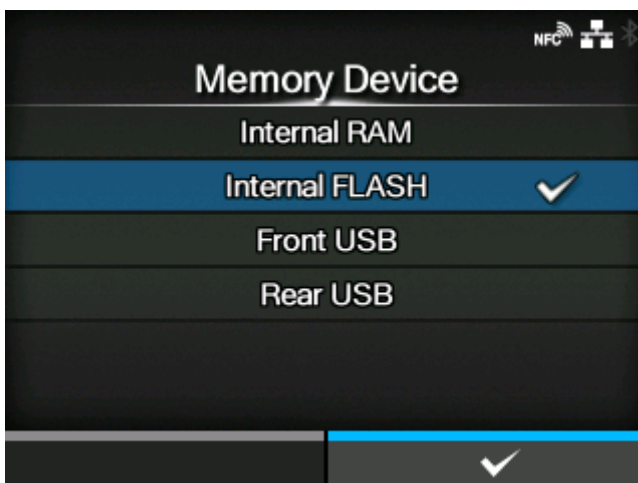

Select the product's memory space in which to store forms, graphics and fonts.

The options are as follows:

Internal RAM

Use the product's internal RAM. The data will be lost if the product is powered off.

Internal FLASH

Use the product's internal ROM.

Front USB

Use the USB memory connected to the USB connector (Type A) on the front side of the product.

Rear USB

Use the USB memory connected to the USB connector (Type A) on the rear side of the product.



- Be sure to perform a virus check on the USB memory before connecting it to the product. SATO Corporation shall not be held responsible for any product malfunctions caused by a virus spread via USB memory.
-

[Sim. 300 DPI Head]

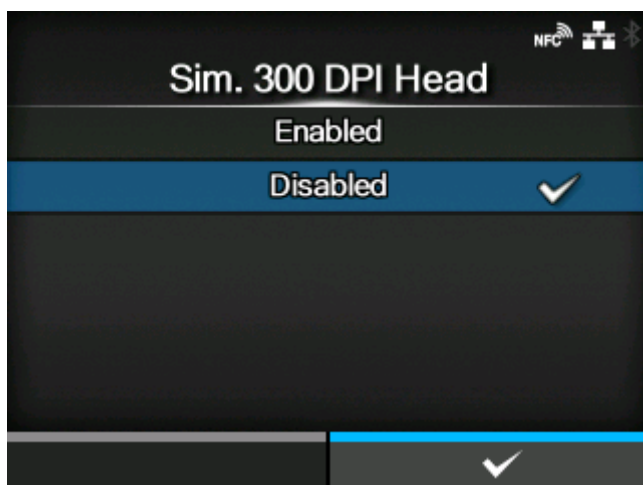

When you are using the product with 305 dpi resolution, enable or disable 300 dpi simulation mode.

The options are as follows:

Enabled

Enable 300 dpi simulation mode. The sizes and positions of objects such as lines, boxes and barcodes in the print data are automatically adjusted to the equivalent 300 dpi sizes and positions for printing.

Disabled

Disable 300 dpi simulation mode.

[AEP]

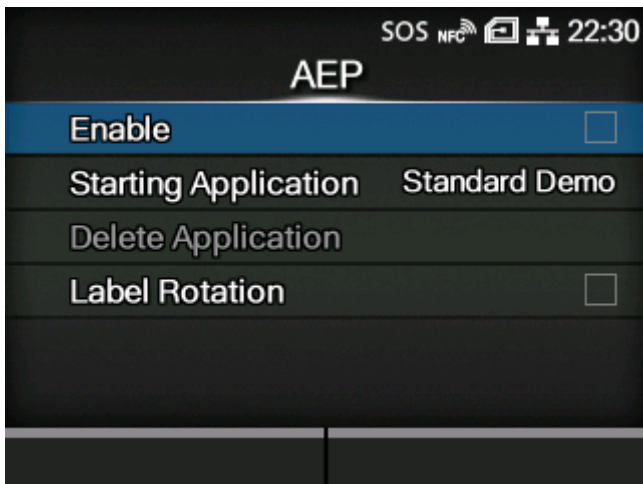

Set the functions for AEP (Application Enabled Printing).

AEP mode allows you to use the product as a stand-alone printer by running applications within the product.

Use the standard application, or install custom applications to the product from a USB memory, All-In-One Tool, WebConfig page, etc.

In AEP mode, you can use USB keyboards and barcode scanners to input data.

The setting items are as follows:

[Enable](#)

Enable or disable AEP mode.

[Starting Application](#)

Select the application to start at product startup in AEP mode.

[Delete Application](#)

Delete installed applications.

[Label Rotation](#)

Set whether to rotate the page orientation for label printing.



- Contact your SATO sales representative for more information about the use of AEP mode.
-

[Enable]

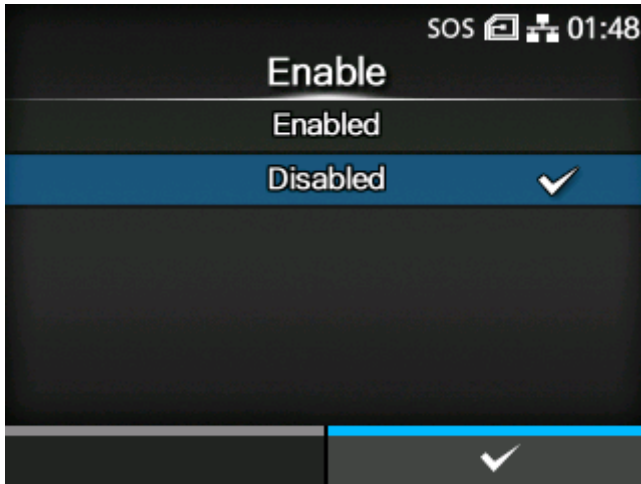

Enable or disable AEP (Application Enabled Printing) mode.

The options are as follows:

Enabled

Enable AEP mode.

Disabled

Disable AEP mode.



- A message prompting you to restart the product will appear on the Online/Offline screen if you have made any changes. In such a case, reboot the product to apply the settings.

[Starting Application]

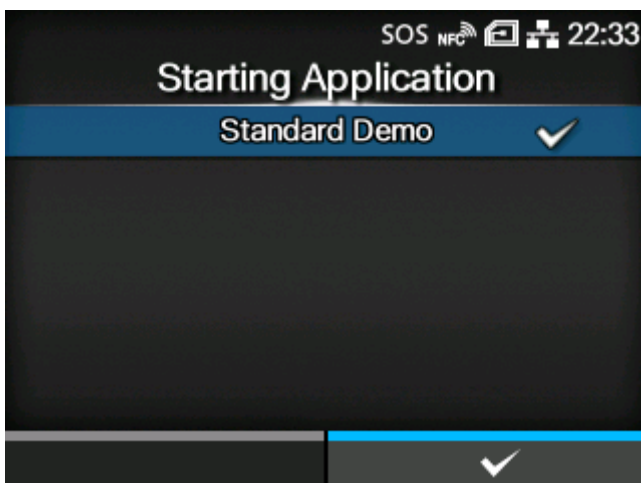

Select the application to start at product startup in AEP (Application Enabled Printing) mode.

Select the application using the ▲ / ▼ buttons and press the  button to confirm.

[Delete Application]

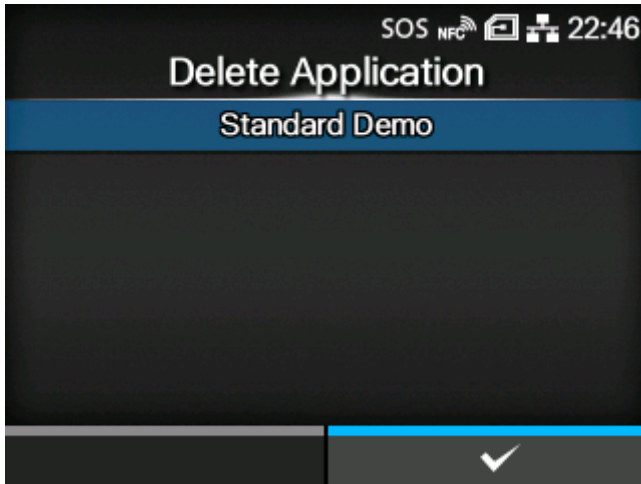

Delete installed applications from the list.

Select the application to be deleted using the ▲ / ▼ buttons and press the ☰ button to confirm.

[Label Rotation]

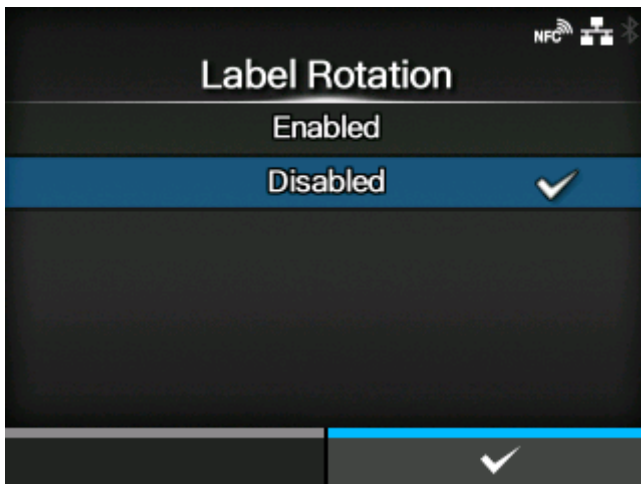

Set whether to rotate the page orientation for label printing.

The options are as follows:

Enabled

Rotates the page orientation 180 degrees.

Disabled

Does not rotate the page orientation.

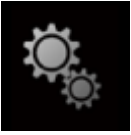

[System] Menu

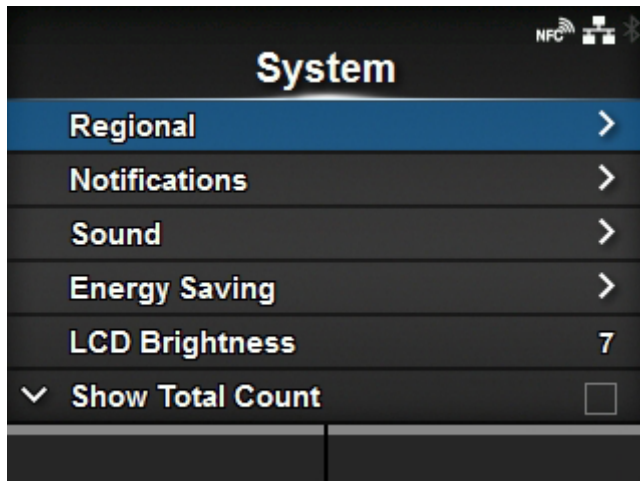

The following settings are available in the [System] menu:

[Regional](#)

Set the display language, time zone, calendar (option) and unit.

[Notifications](#)

Set the function to notify when to clean and replace parts.

[Sound](#)

Set the buzzer sound.

[Energy Saving](#)

Set the period before the product enters sleep mode.

[LCD Brightness](#)

Set the brightness of the screen.

[Show Total Count](#)

Enable or disable the indication of the total print count.

[Password](#)

Set the password.

[Start on AC](#)

Set whether to power on/off the product by powering on/off the main power source.

[Regional]

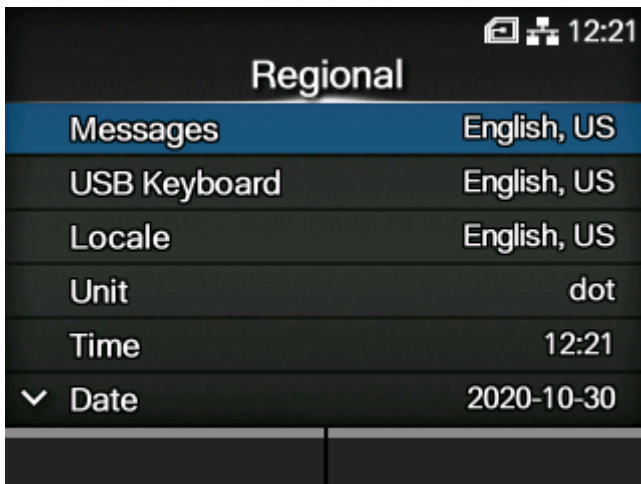

Regional	
Messages	English, US
USB Keyboard	English, US
Locale	English, US
Unit	dot
Time	12:21
▼ Date	2020-10-30

Set the display language, time zone, calendar (option) and unit.

The setting items are as follows:

[Messages](#)

Set the display language of the LCD.

[USB Keyboard](#)

Set the language for the USB keyboard connected to the product.

[Locale](#)

Set the locale to be used in AEP (Application Enabled Printing) mode.

[Unit](#)

Set the unit of length for indication.

[Time](#)

Set the time.



- You can set the time only if you have installed the optional RTC kit.
-

[Date](#)

Set the date.



- You can set the date only if you have installed the optional RTC kit.
-

[Time Zone](#)

Set the time zone.

[Display Language Icon](#)

Set whether to display the [Language] icon on the top screen of the [Settings] menu.

[Messages]

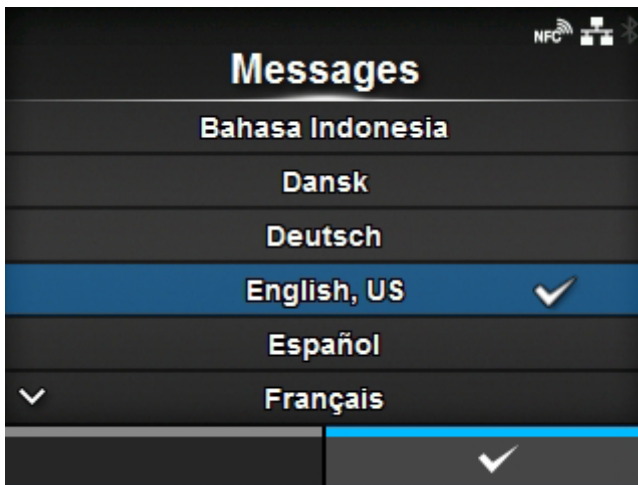

Set the display language of the LCD.
Select the display language from the list.

[USB Keyboard]



Set the language for the USB keyboard connected to the product.
Select the USB keyboard layout from Western and Eastern European languages, Japanese, Chinese and Korean.



- Japanese, Chinese, and Korean only support a change in the layout of the keyboard. The IME (Input Method Editor) is not compatible, so you cannot input hiragana, katakana, or kanji.

[Locale]



Set the locale to be used in AEP (Application Enabled Printing) mode.

This setting determines the format of time, dates, numbers, prices, names of weekdays, months, etc. in AEP applications.

Select the locale from the list.

[Unit]

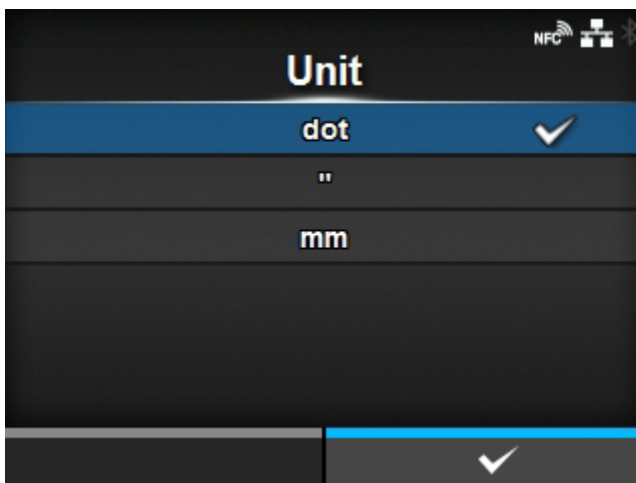

Set the unit of length for indication.

The options are as follows:

- [dot]
- ["] (inches)
- [mm]

[Time]

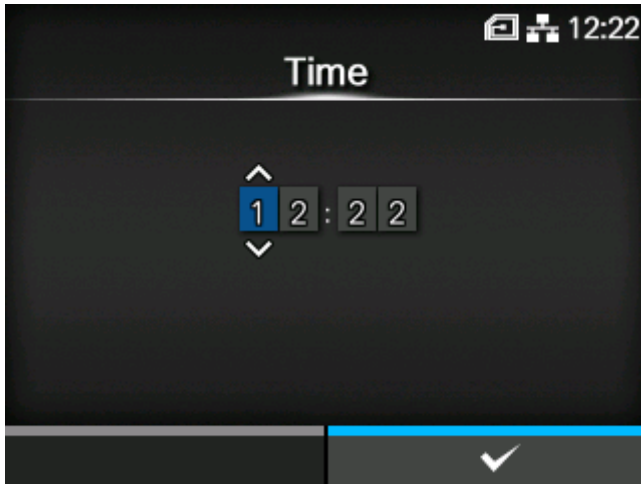



Set the time.

You can set the time only if you have installed the optional RTC kit.

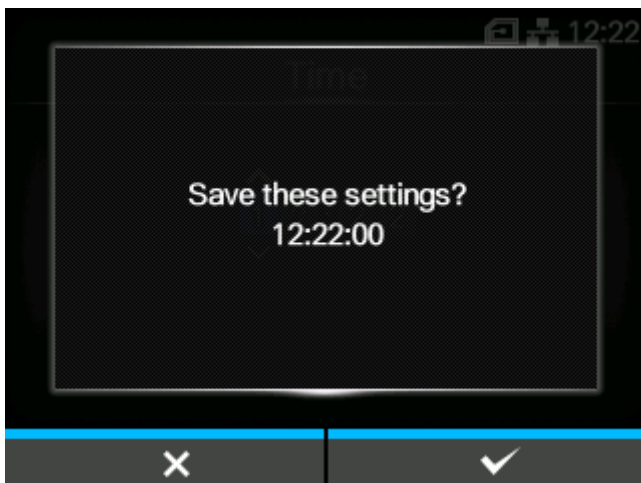
After setting the time and pressing the  button, the confirmation screen appears.



Press the  button to cancel, or press the  button to confirm the setting.

[Date]

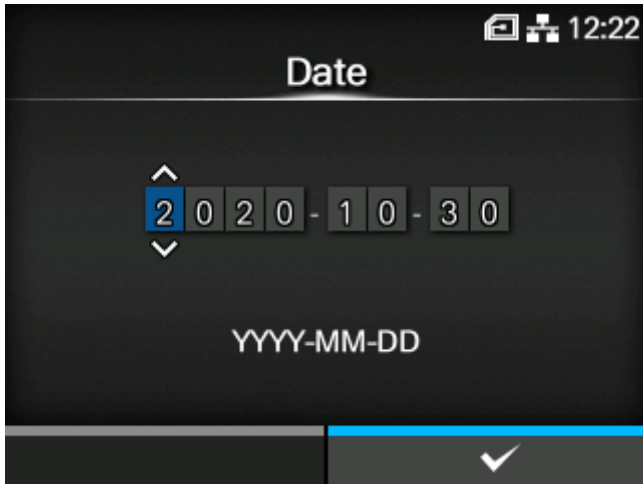

Set the date.

You can set the date only if you have installed the optional RTC kit.

The setting range is as follows:



2000-01-01 to 2035-12-31

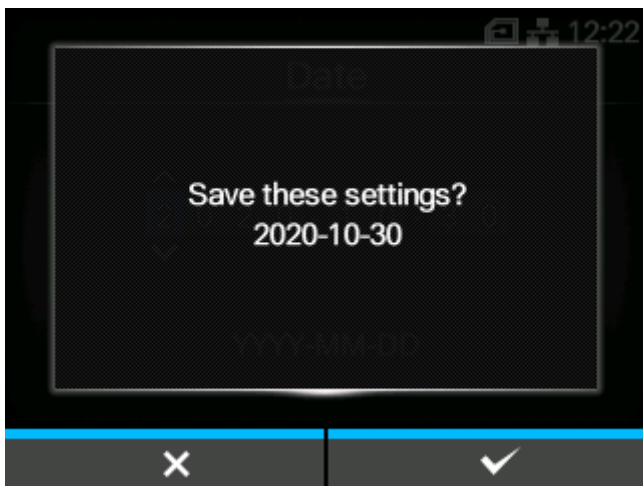

- The date format is Year - Month - Date.

After setting the date and pressing the  button, the confirmation screen appears.



Press the  button to cancel, or press the  button to confirm the setting.

[Time Zone]

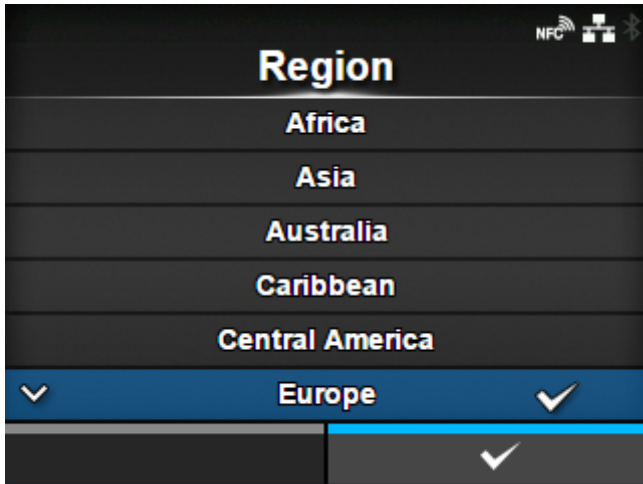

Set the time zone.

First select the region from the [Region] list.

Then select the city from the [City] list.

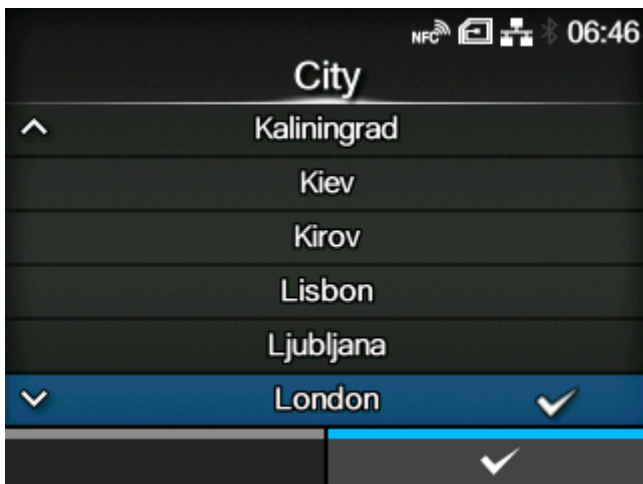

[Display Language Icon]

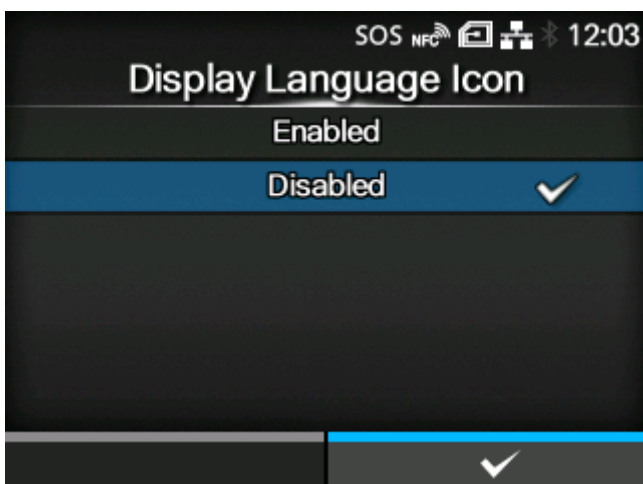

Set whether to display the [Language] icon on the top screen of the [Settings] menu.

The options are as follows:

Enabled

Display the [Language] icon.

Disabled

Do not display the [Language] icon.

If this function is enabled, the [Language] icon is added to the [Settings] menu screen as below. You can directly access the display language setting screen.

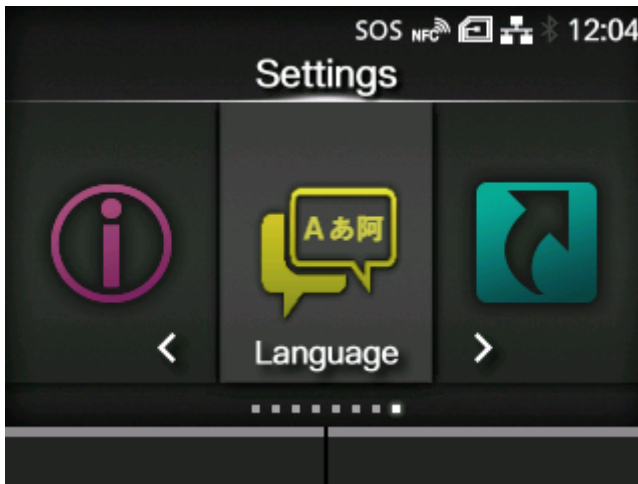

[Notifications]

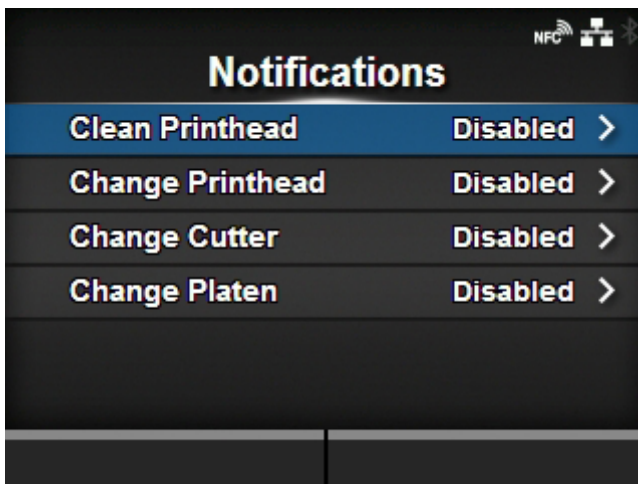

Set the function to notify when to clean and replace parts.

The setting items are as follows:

[Clean Printhead](#)

Notify when the print head needs to be cleaned.

[Change Printhead](#)

Notify when the print head needs to be replaced.

[Change Cutter](#)

Notify when the cutter unit needs to be replaced.

[Change Platen](#)

Notify when the platen roller needs to be replaced.

[Clean Printhead]

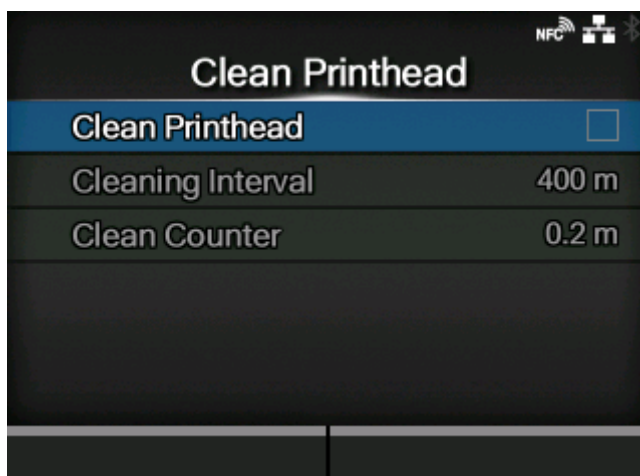

Notify when the print head needs to be cleaned.

The setting items are as follows:

[Clean Printhead](#)

Enable or disable the notification function about when the print head needs to be cleaned.

[Cleaning Interval](#)

Set the notification interval about when the print head needs to be cleaned.

[Clean Counter](#)

Shows the current print distance.

[Clean Printhead]

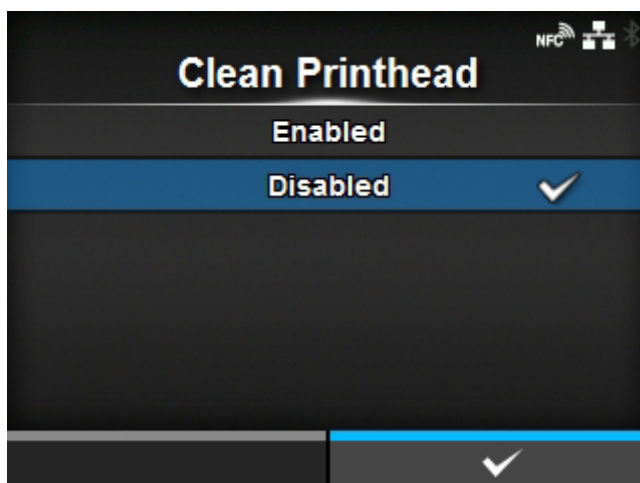

Enable or disable the notification function about when the print head needs to be cleaned.

The options are as follows:

Enabled

Enable the notification function.

Disabled

Disable the notification function.

[Cleaning Interval]

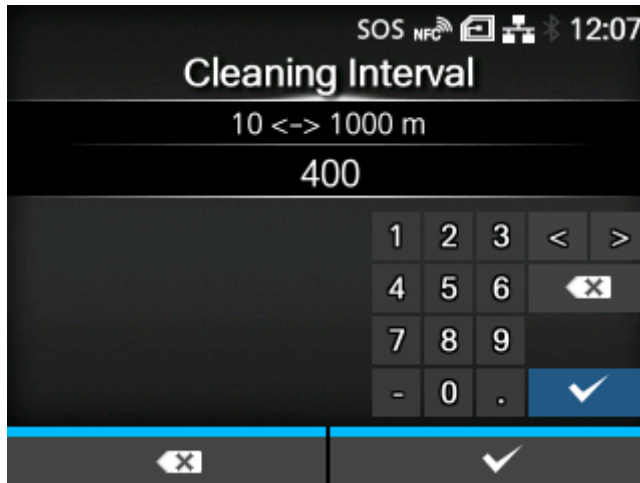

Set the notification interval about when the print head needs to be cleaned.

You can change this setting if you have selected [Enabled] in the [Clean Printhead] menu.

The product shows the print distance as a set value. The setting range is from 10 to 1000 meters.

[Change Printhead]

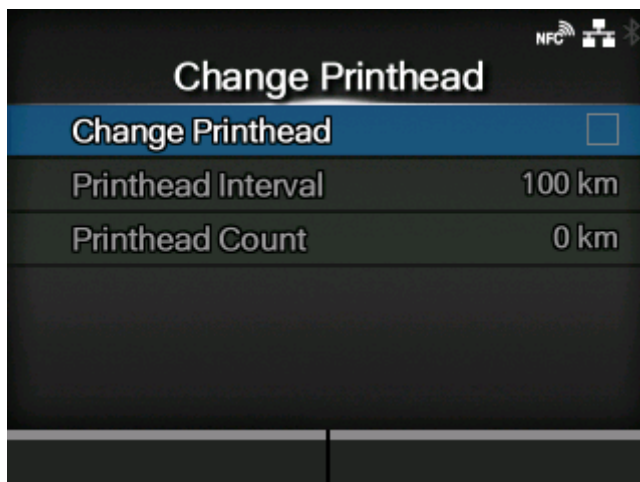

Notify when the print head needs to be replaced.

The setting items are as follows:

Change Printhead

Enable or disable the notification function about when the print head needs to be replaced.

Printhead Interval

Set the notification interval about when the print head needs to be replaced.

Printhead Count

Shows the current print distance.

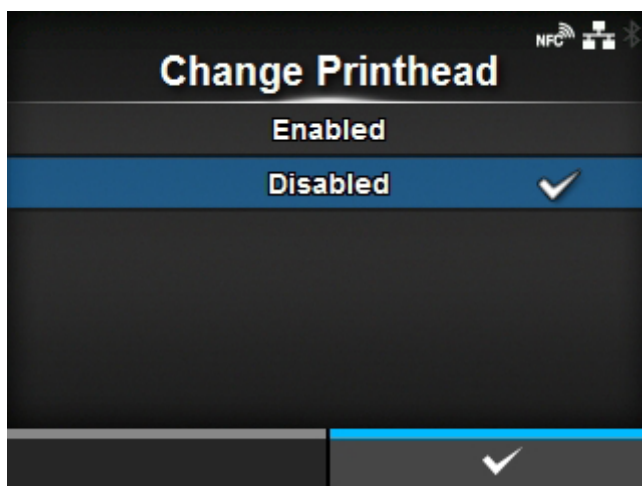
[Change Printhead]

Enable or disable the notification function about when the print head needs to be replaced.

The options are as follows:

Enabled

Enable the notification function.

Disabled

Disable the notification function.

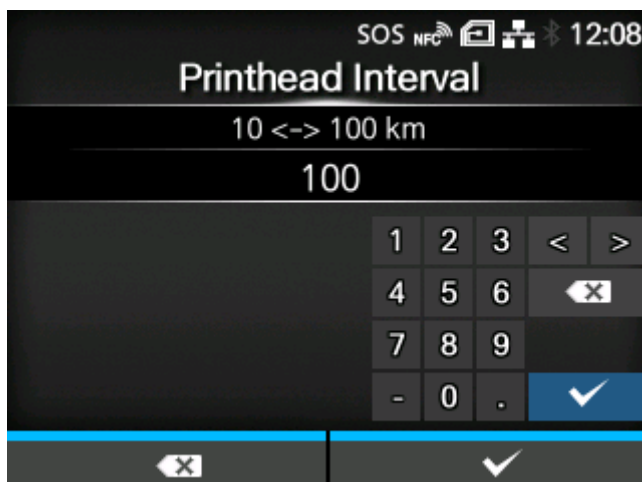
[Printhead Interval]

Set the notification interval about when the print head needs to be replaced.

You can change this setting if you have selected [Enabled] in the [Change Printhead] menu.

The product shows the print distance as a set value. The setting range is from 10 to 100 km.

[Change Cutter]



Notify when the cutter unit needs to be replaced.

The setting items are as follows:

[Change Cutter](#)

Enable or disable the notification function about when the cutter unit needs to be replaced.

[Cutter Life](#)

Set the notification interval about when the cutter unit needs to be replaced.

[Cutter Count](#)

Shows the current number of cuts by the cutter.

[Change Cutter]

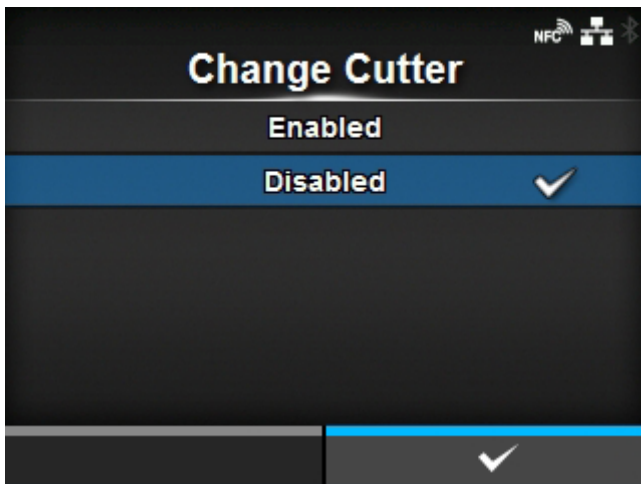

Enable or disable the notification function about when the cutter unit needs to be replaced.

The options are as follows:

[Enabled](#)

Enable the notification function.

Disabled

Disable the notification function.

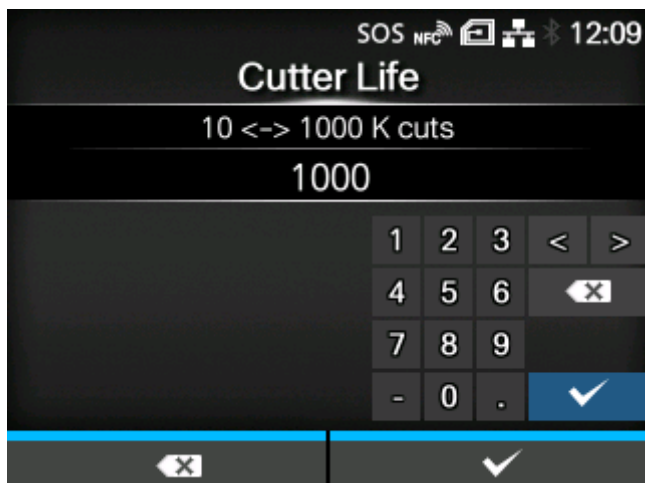
[Cutter Life]

Set the notification interval about when the cutter unit needs to be replaced.

You can change this setting if you have selected [Enabled] in the [Change Cutter] menu.

The product shows the cutter count as a set value. The setting range is from 10,000 to 1,000,000 cuts.

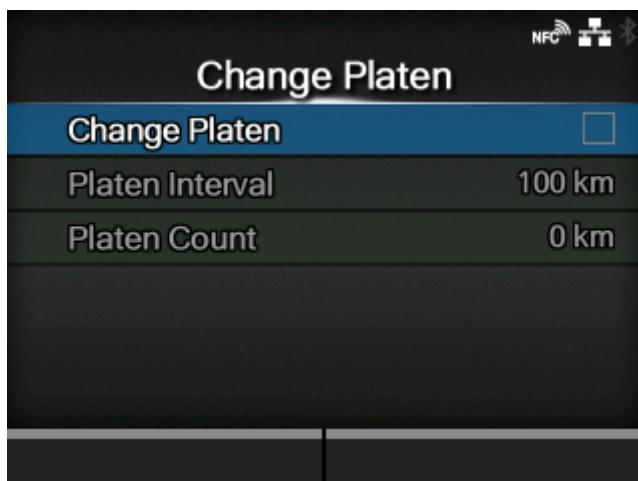
[Change Platen]

Notify when the platen roller needs to be replaced.

The setting items are as follows:

[Change Platen](#)

Enable or disable the notification function about when the platen roller needs to be replaced.

[Platen Interval](#)

Set the notification interval about when the platen roller needs to be replaced.

[Platen Count](#)

Shows the current distance the platen roller has fed.

[Change Platen]

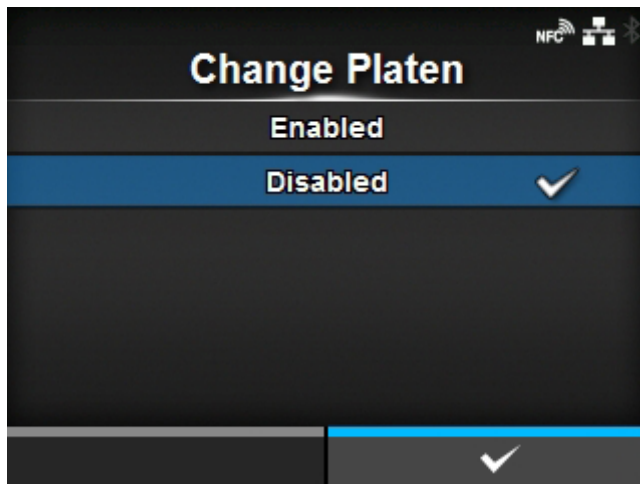

Enable or disable the notification function about when the platen roller needs to be replaced.

The options are as follows:

Enabled

Enable the notification function.

Disabled

Disable the notification function.

[Platen Interval]



Set the notification interval about when the platen roller needs to be replaced.

You can change this setting if you have selected [Enabled] in the [Change Platen] menu.

The product shows the fed distance as a set value. The setting range is from 10 to 100 km.

[Sound]

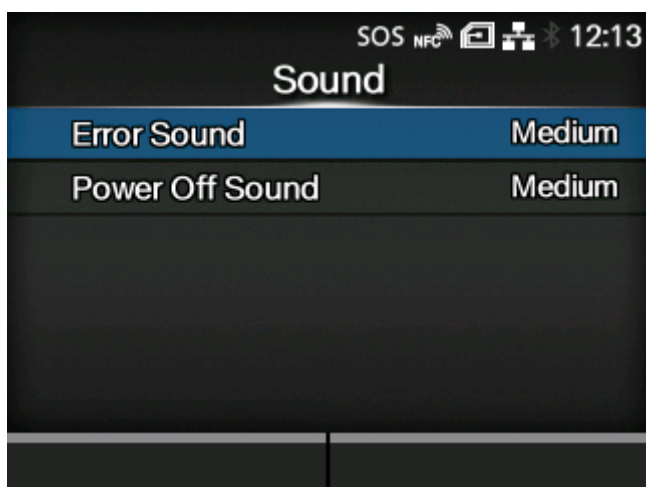

Set the buzzer sound.

The setting item is as follows:

[Error Sound](#)

Set the buzzer volume for the error sound.

[Power Off Sound](#)

Set the buzzer volume when powering off the product.

[Error Sound]

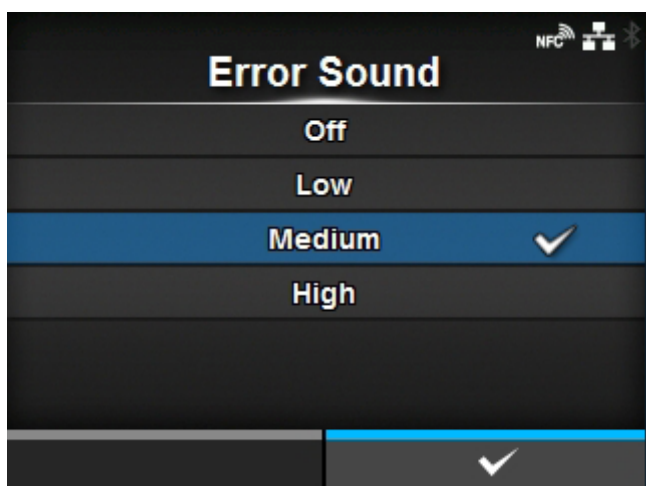

Set the buzzer volume for the error sound.

The options are as follows:

[Off](#)

Mute the sound.

Low

Low volume.

Medium

Medium volume.

High

High volume.

[Power Off Sound]

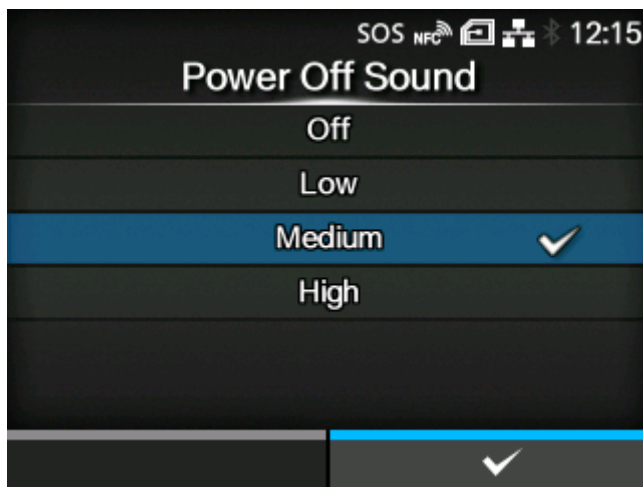

Set the buzzer volume when powering off the product.

The options are as follows:

Off

Mute the sound.

Low

Low volume.

Medium

Medium volume.

High

High volume.

[Energy Saving]

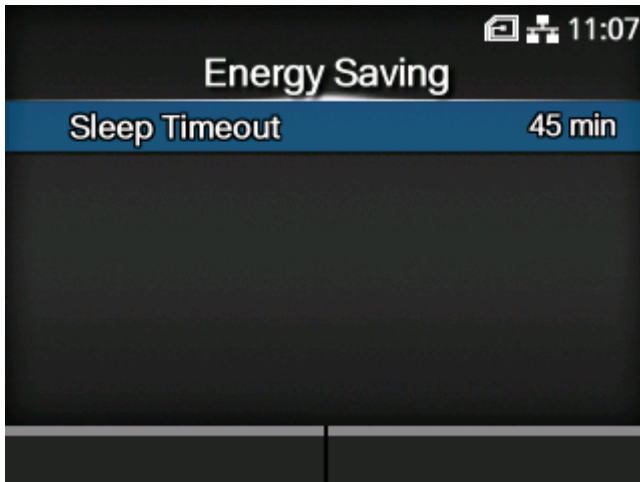

The setting item is as follows:

[Sleep Timeout](#)

Set the period before the product enters sleep mode.

[Sleep Timeout]

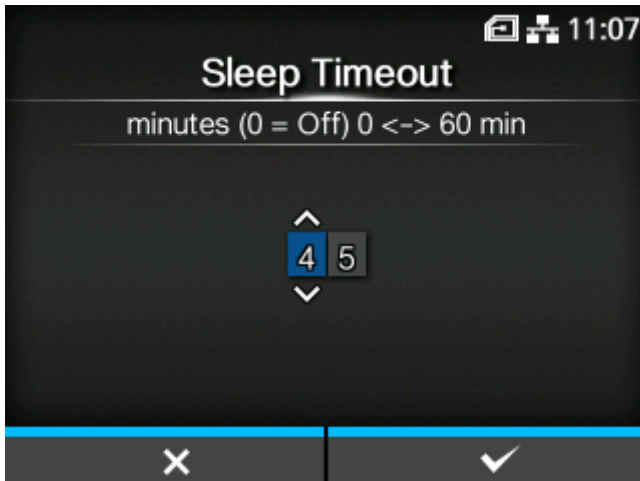

Set the period before the product enters sleep mode.

The setting range is from 0 to 60 minutes.



- The sleep function is disabled if you set to 0.
- This setting is disabled if [Print Start Signal] is set to [Enabled].
- For RFID models, the sleep function is disabled.

[LCD Brightness]

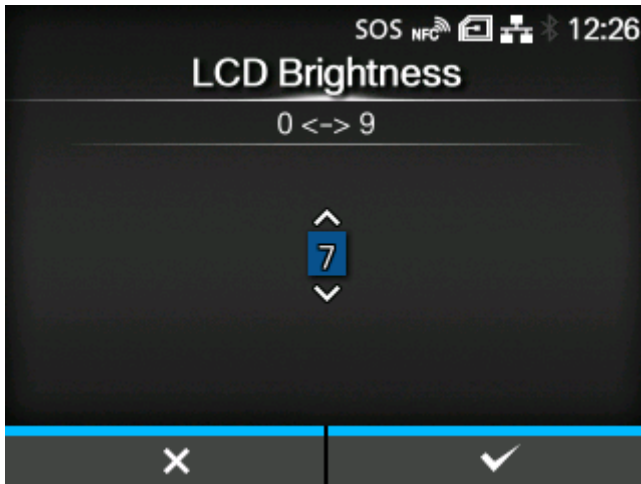

Set the brightness of the screen.

The setting range is from 0 to 9.

0 is the darkest and 9 is the brightest.

Press the  button to complete the setting.



- The product has a built-in energy saving function, which will decrease the brightness of the screen when you have not operated the product for a period.

[Show Total Count]

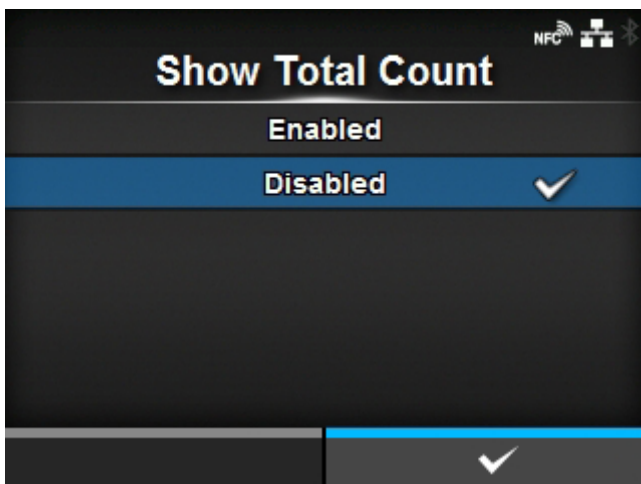

Enable or disable the indication of the total print count.

If set to [Enabled], the total print count appears on both the Online and Offline screens.

The number in the brackets to the right of [QTY] on the Online and Offline screens is the total print count.

The options are as follows:

Enabled

Enable the indication of the total print count.

Disabled

Disable the indication of the total print count.



- Shows the total print count from the time the product is on until it is off. When you power off the product, the count is reset to [0].
-

[Password]

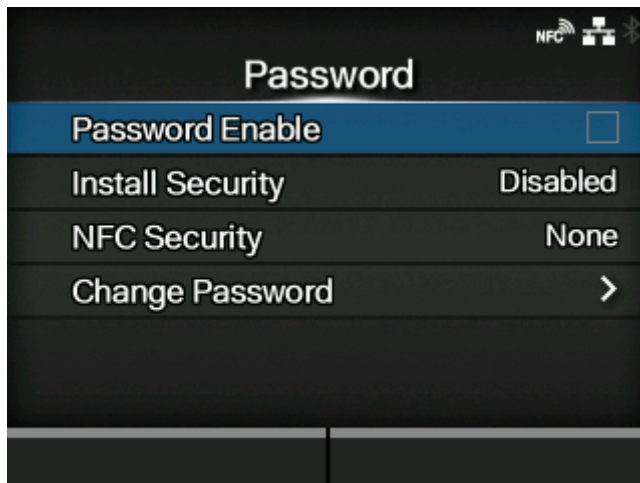

The setting items are as follows:

[Password Enable](#)

Enable or disable the password setting.

[Install Security](#)

Enable or disable the password input for the package file download.

[NFC Security](#)

Set whether to show the confirmation message or enable the password input before settings are written to the product from an Android device with the NFC interface.

[Change Password](#)

Change the password.

[Password Enable]

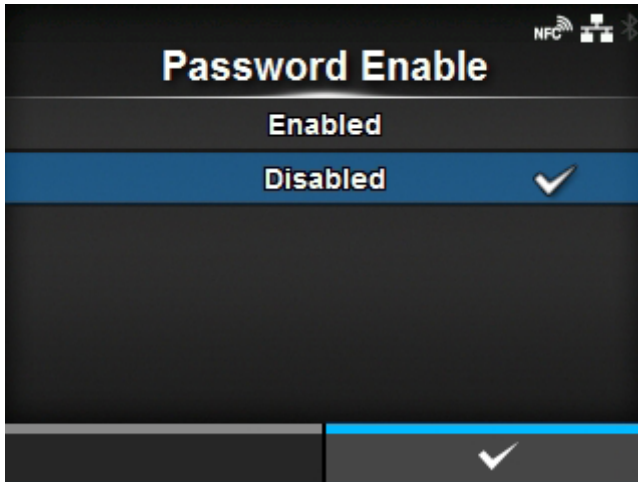

Enable or disable the password setting.

If you have set the password to [Enabled], the product requires you to enter the password set in the [Password] screen before you enter the [Settings] menu.

The options are as follows:

Enabled

Enable the password setting.

Disabled

Disable the password setting.



- The default password is 0310. You can change the password in [Password] > [Change Password] > [level1].
-

[Install Security]

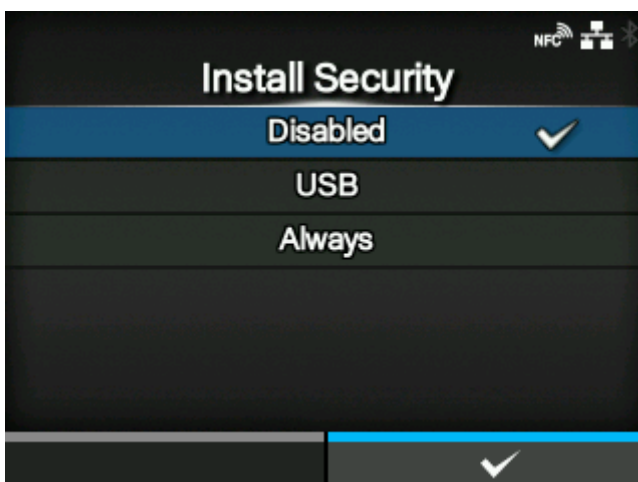

Enable or disable the password input for installing the pkg file to the product.

If you have enabled the password input, the product requires you to enter the password set in the [Password] screen before you can download the package file.

The options are as follows:

Disabled

No password is required to install a pkg file.

USB

Password is required to install a pkg file from the USB memory.

Always

Password is required to install a pkg file from the USB memory or downloaded from computer.



- The password used for installing a pkg file can be any passwords set in the [System] > [Password].

Contact your SATO reseller or technical support center for more information of the pkg file.

[NFC Security]

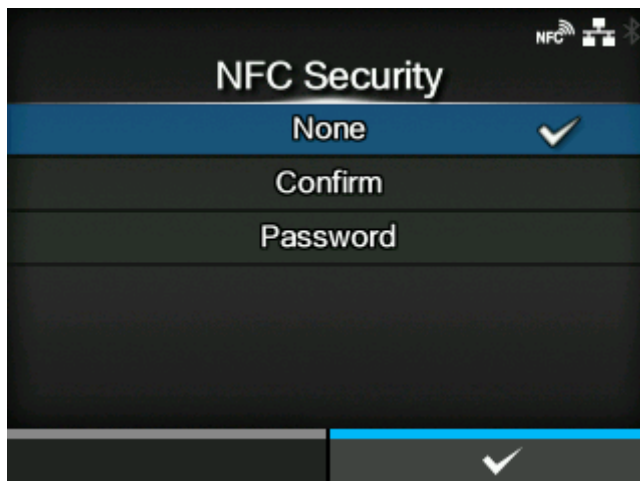

Set whether to show the confirmation message or enable the password input before settings are written to the product from an Android device with the NFC interface.

To use the NFC Security function, the settings must be written from the Android device while the product is powered off. The confirmation message or password input screen is shown when the product is powered on.

The options are as follows:

None

No confirmation message is shown and no password is required before the settings are written to the product.

Confirm

The confirmation message is shown before the settings are written to the product.

Password

You need to enter the password set in the [Password] screen before the settings are written to the product.

[Change Password]

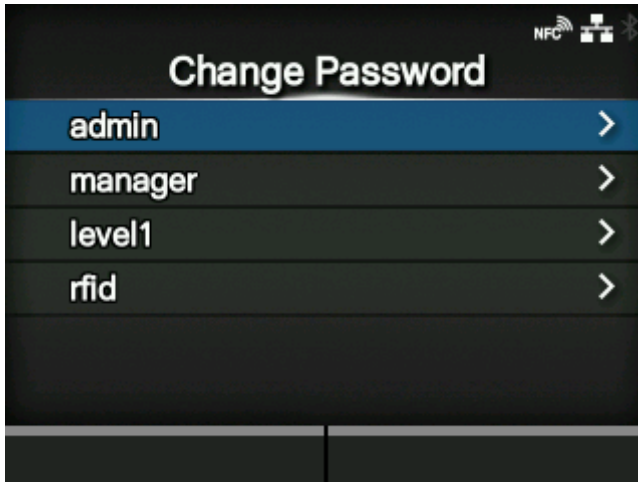

Change the password.

You can enter 4 to 32 characters. Alphabets (capital and small letters), numbers and symbols can be used.

The setting items are as follows:

admin

This is the setting item for factory.

Strictly for SATO authorized personnel use.

manager

The password for accessing the [Service] menu.

Strictly for SATO authorized personnel use.

level1

The password for accessing the [Settings] menu.

rfid

This is the setting item for factory.

Strictly for SATO authorized service personnel use.



- The [admin], [manager] and [rfid] passwords are for factory and maintenance personnel. You cannot change these passwords.
-

[Start on AC]

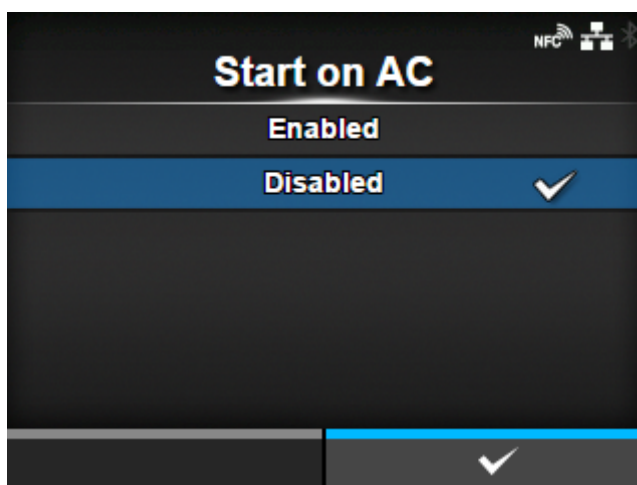

Set whether to power on/off the product by powering on/off the main power source.

The options are as follows:

Enabled

Power on/off the product by powering on/off the main power source.

Disabled

Power on/off the product by pressing the  power button of the product.



- Do not repeatedly power on/off the product.
 - If you power the main power source off and then on again quickly, the product may not be powered on because it is still in the powering off process. In such a case, press the  power button to power on the product.
 - Do not power off the product during operation, such as when printing or updating. Doing so could cause a malfunction of the product.
 - Do not disconnect the power cord until the powering off process is completed on the product.
 - An incorrect power on/off operation may damage the product settings. In such a case, the product settings are reset to their default values. It is always recommended to use the power button to allow proper shutdown of the product and ensure changes made to menu settings are saved appropriately.
-



[Tools] Menu

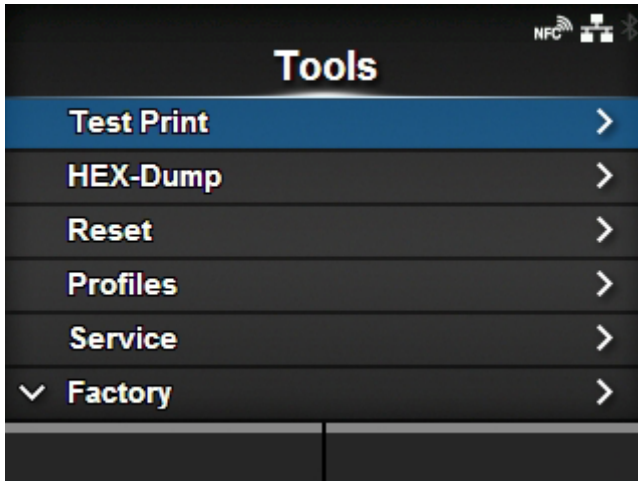

The following settings are available in the [Tools] menu:

[Test Print](#)

Perform a test print.

[HEX-Dump](#)

Save the hex dump print data or dump data from the receive buffer to the USB memory.

[Reset](#)

Initialize the settings and counters on the product.

[Profiles](#)

Save the product's settings as a profile to be loaded as needed.

[Service](#)

These are the setting items for service.

Strictly for SATO authorized service personnel use.

[Factory](#)

These are the setting items for factory.

Strictly for SATO authorized service personnel use.

[Certificates](#)

Set the wireless LAN authentication.

- Available only if you have installed the USB memory.

[Barcode Checker](#)

Set the barcode check function using a barcode checker.

[Clone](#)

Copy the current product settings and data to the USB memory.

- Available only if you have installed the USB memory.

[Support Info](#)

Save various information about the product in a text file to the USB memory.

- Available only if you have installed the USB memory.

[Logging Function](#)

Save the log data.

[Startup Guide](#)

Enable or disable the startup guide.

[Test Print]

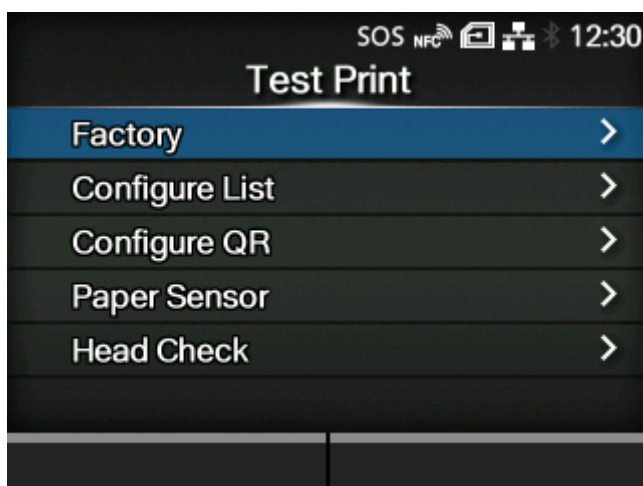

Perform a test print.

The setting items are as follows:

[Factory](#)

Perform the factory test print.

[Configure List](#)

Print the product's settings information.

[Configure QR](#)

Print the product's settings information as a QR code.

[Paper Sensor](#)

Print the detection result of the media sensor level.



[Head Check](#)

Perform the head check print.

[Factory]



Perform the factory test print.

1. Check and set the items as listed on the [Factory] menu.
2. Press the  button to start the test print. Press the  button again to pause the print.

To stop the test print, first pause the print and then press the  button.

The setting items are as follows:

Label Width

Set the media width used for the test print.

The options are [Large] (101.6 mm (4") and [Small] (50.8 mm (2"))).

Pitch

Set the print position in the vertical direction.

The setting range varies depending on the print resolution of the product.

The setting range is as follows:

Resolution	CL4NX Plus	CL6NX Plus
203dpi (1 dot = 0.125 mm (0.0049"))	-30 to 0 to 30 dots	-30 to 0 to 30 dots
305dpi (1 dot = 0.083 mm (0.0033"))	-45 to 0 to 45 dots	-45 to 0 to 45 dots
609dpi	-90 to 0 to 90 dots	-

Resolution	CL4NX Plus	CL6NX Plus
(1 dot = 0.042 mm (0.0017"))		

When you decrease the setting value, the print position moves in the feed direction (toward the front part of the media).

When you increase the setting value, the print position moves opposite the feed direction (toward the end part of the media).

Offset

Set the stop position of the media.

The setting range varies depending on the print resolution of the product.

The setting range is as follows:

Resolution	CL4NX Plus	CL6NX Plus
203dpi (1 dot = 0.125 mm (0.0049"))	-30 to 0 to 30 dots	-30 to 0 to 30 dots
305dpi (1 dot = 0.083 mm (0.0033"))	-45 to 0 to 45 dots	-45 to 0 to 45 dots
609dpi (1 dot = 0.042 mm (0.0017"))	-90 to 0 to 90 dots	-

When you decrease the setting value, the stop position moves in the feed direction (toward the front part of the media).

When you increase the setting value, the stop position moves opposite the feed direction (toward the end part of the media).

Darkness Adjust

Fine tune the print darkness of the test print.

0 is the lightest and 99 is the darkest.



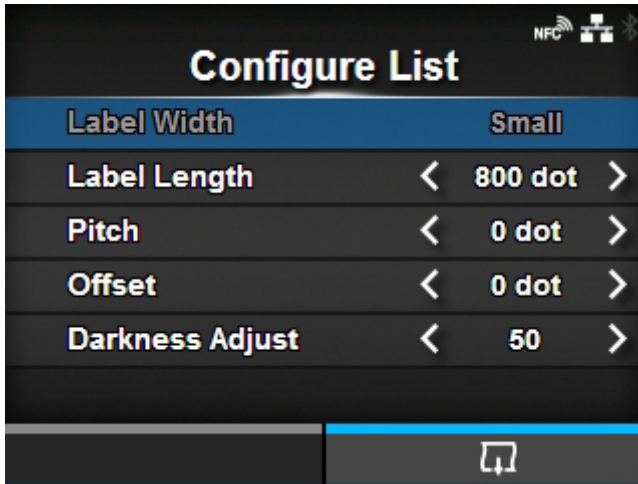

- The value of [Pitch], [Offset] and [Darkness Adjust] set in the [Factory] menu will be reflected to the same item settings in the [Configure List] menu, [Configure QR] menu, [Paper Sensor] menu and [Head Check] menu.

[Configure List]



Print the product's settings information.

1. Check and set the items as listed on the [Configure List] menu.
2. Press the  button to start the test print. Press the  button again to pause the print.

To stop the test print, first pause the print and then press the  button.

The setting items are as follows:

Label Width

Shows the necessary media width of the test print.

The necessary media width is 50.8 mm (2") for [Small].

Label Length

Set the length of one piece of the media used for the test print.

The setting range varies depending on the print resolution of the product.

The setting range is as follows:

Resolution	CL4NX Plus	CL6NX Plus
203 dpi (1 dot = 0.125 mm (0.0049"))	400 to 1600 dots	400 to 1600 dots
305 dpi (1 dot = 0.083 mm (0.0033"))	600 to 2400 dots	600 to 2400 dots
609 dpi (1 dot = 0.042 mm (0.0017"))	1200 to 4800 dots	-

Pitch

Set the print position in the vertical direction.

The setting range varies depending on the print resolution of the product.

The setting range is as follows:

Resolution	CL4NX Plus	CL6NX Plus
203 dpi (1 dot = 0.125 mm (0.0049"))	-30 to 0 to 30 dots	-30 to 0 to 30 dots
305 dpi (1 dot = 0.083 mm (0.0033"))	-45 to 0 to 45 dots	-45 to 0 to 45 dots
609 dpi (1 dot = 0.042 mm (0.0017"))	-90 to 0 to 90 dots	-

When you decrease the setting value, the print position moves in the feed direction (toward the front part of the media).

When you increase the setting value, the print position moves opposite the feed direction (toward the end part of the media).

Offset

Set the stop position of the media.

The setting range varies depending on the print resolution of the product.

The setting range is as follows:

Resolution	CL4NX Plus	CL6NX Plus
203 dpi (1 dot = 0.125 mm (0.0049"))	-30 to 0 to 30 dots	-30 to 0 to 30 dots
305 dpi (1 dot = 0.083 mm (0.0033"))	-45 to 0 to 45 dots	-45 to 0 to 45 dots
609 dpi (1 dot = 0.042 mm (0.0017"))	-90 to 0 to 90 dots	-

When you decrease the setting value, the stop position moves in the feed direction (toward the front part of the media).

When you increase the setting value, the stop position moves opposite the feed direction (toward the end part of the media).

Darkness Adjust

Fine tune the print darkness of the test print.

0 is the lightest and 99 is the darkest.



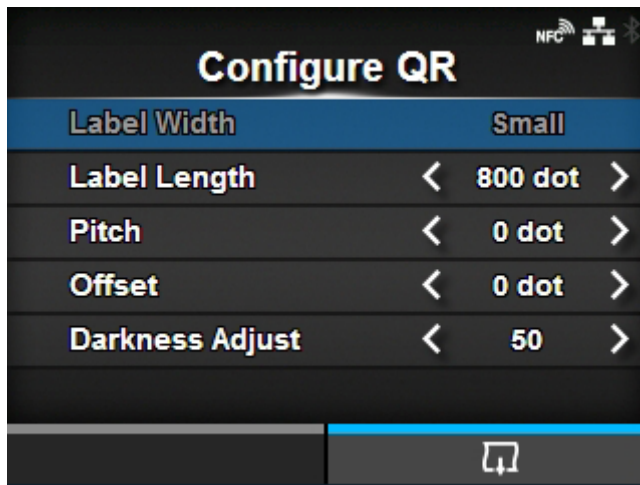

- The value of [Label Length], [Pitch], [Offset] and [Darkness Adjust] set in the [Configure List] menu will be reflected to the same item settings in the [Factory] menu, [Configure QR] menu, [Paper Sensor] menu and [Head Check] menu.

[Configure QR]

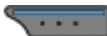
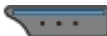

Print the product's settings information as a QR code.

- Check and set the items as listed on the [Configure QR] menu.
- Press the  button to start the test print. Press the  button again to pause the print.

To stop the test print, first pause the print and then press the  button.

The setting items are as follows:

Label Width

Shows the necessary media width of the test print.

The necessary media width is 50.8 mm (2") for [Small].

Label Length

Set the length of one piece of the media used for the test print.

The setting range varies depending on the print resolution of the product.

The setting range is as follows:

Resolution	CL4NX Plus	CL6NX Plus
203 dpi	400 to 1600 dots	400 to 1600 dots

Resolution	CL4NX Plus	CL6NX Plus
(1 dot = 0.125 mm (0.0049"))		
305 dpi (1 dot = 0.083 mm (0.0033"))	600 to 2400 dots	600 to 2400 dots
609 dpi (1 dot = 0.042 mm (0.0017"))	1200 to 4800 dots	-

Pitch

Set the print position in the vertical direction.

The setting range varies depending on the print resolution of the product.

The setting range is as follows:

Resolution	CL4NX Plus	CL6NX Plus
203 dpi (1 dot = 0.125 mm (0.0049"))	-30 to 0 to 30 dots	-30 to 0 to 30 dots
305 dpi (1 dot = 0.083 mm (0.0033"))	-45 to 0 to 45 dots	-45 to 0 to 45 dots
609 dpi (1 dot = 0.042 mm (0.0017"))	-90 to 0 to 90 dots	-

When you decrease the setting value, the print position moves in the feed direction (toward the front part of the media).

When you increase the setting value, the print position moves opposite the feed direction (toward the end part of the media).

Offset

Set the stop position of the media.

The setting range varies depending on the print resolution of the product.

The setting range is as follows:

Resolution	CL4NX Plus	CL6NX Plus
203 dpi (1 dot = 0.125 mm (0.0049"))	-30 to 0 to 30 dots	-30 to 0 to 30 dots
305 dpi	-45 to 0 to 45 dots	-45 to 0 to 45 dots

Resolution	CL4NX Plus	CL6NX Plus
(1 dot = 0.083 mm (0.0033"))		
609 dpi (1 dot = 0.042 mm (0.0017"))	-90 to 0 to 90 dots	-

When you decrease the setting value, the stop position moves in the feed direction (toward the front part of the media).

When you increase the setting value, the stop position moves opposite the feed direction (toward the end part of the media).

Darkness Adjust

Fine tune the print darkness of the test print.

0 is the lightest and 99 is the darkest.



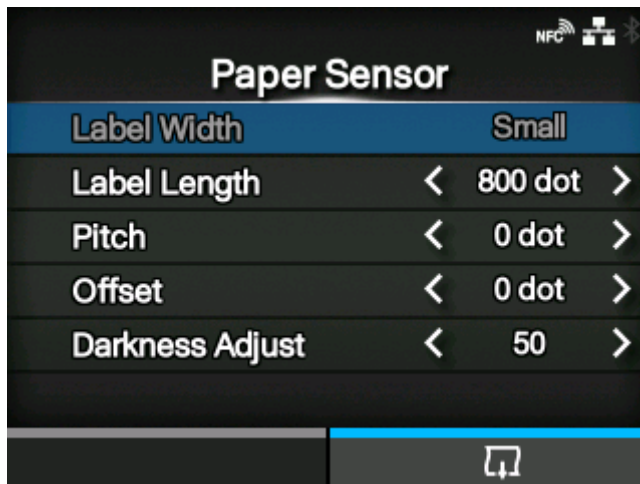

- The value of [Label Length], [Pitch], [Offset] and [Darkness Adjust] set in the [Configure QR] menu will be reflected to the same item settings in the [Factory] menu, [Configure List] menu, [Paper Sensor] menu and [Head Check] menu.

[Paper Sensor]



Print the detection result of the media sensor level.

1. Check and set the items as listed on the [Paper Sensor] menu.
2. Press the  button to start the test print. Press the  button again to pause the print.

To stop the test print, first pause the print and then press the  button.

The setting items are as follows:

Label Width

Shows the necessary media width of the test print.

The necessary media width is 50.8 mm (2") for [Small].

Label Length

Set the length of one piece of the media used for the test print.

The setting range varies depending on the print resolution of the product.

The setting range is as follows:

Resolution	CL4NX Plus	CL6NX Plus
203 dpi (1 dot = 0.125 mm (0.0049"))	400 to 1600 dots	400 to 1600 dots
305 dpi (1 dot = 0.083 mm (0.0033"))	600 to 2400 dots	600 to 2400 dots
609 dpi (1 dot = 0.042 mm (0.0017"))	1200 to 4800 dots	-

Pitch

Set the print position in the vertical direction.

The setting range varies depending on the print resolution of the product.

The setting range is as follows:

Resolution	CL4NX Plus	CL6NX Plus
203 dpi (1 dot = 0.125 mm (0.0049"))	-30 to 0 to 30 dots	-30 to 0 to 30 dots
305 dpi (1 dot = 0.083 mm (0.0033"))	-45 to 0 to 45 dots	-45 to 0 to 45 dots
609 dpi (1 dot = 0.042 mm (0.0017"))	-90 to 0 to 90 dots	-

When you decrease the setting value, the print position moves in the feed direction (toward the front part of the media).

When you increase the setting value, the print position moves opposite the feed direction (toward the end part of the media).

Offset

Set the stop position of the media.

The setting range varies depending on the print resolution of the product.

The setting range is as follows:

Resolution	CL4NX Plus	CL6NX Plus
203 dpi (1 dot = 0.125 mm (0.0049"))	-30 to 0 to 30 dots	-30 to 0 to 30 dots
305 dpi (1 dot = 0.083 mm (0.0033"))	-45 to 0 to 45 dots	-45 to 0 to 45 dots
609 dpi (1 dot = 0.042 mm (0.0017"))	-90 to 0 to 90 dots	-

When you decrease the setting value, the stop position moves in the feed direction (toward the front part of the media).

When you increase the setting value, the stop position moves opposite the feed direction (toward the end part of the media).

Darkness Adjust

Fine tune the print darkness of the test print.

0 is the lightest and 99 is the darkest.





- The value of [Label Length], [Pitch], [Offset] and [Darkness Adjust] set in the [Paper Sensor] menu will be reflected to the same item settings in the [Factory] menu, [Configure List] menu, [Configure QR] menu and [Head Check] menu.

[Head Check]



Perform the head check print.

1. Check and set the items as listed on the [Head Check] menu.
2. Press the  button to start the head check print. Press the  button again to pause the print.

To stop the head check print, first pause the print and then press the  button.

The setting items are as follows:

Label Width

Set the media width used for the head check print.

The setting range varies depending on the print resolution of the product.

The setting range is as follows:

Resolution	CL4NX Plus	CL6NX Plus If [Head Base Position] is [Standard]	CL6NX Plus If [Head Base Position] is [Left-justify]
203 dpi (1 dot = 0.125 mm (0.0049"))	320 to 832 dots	320 to 1216 dots	320 to 1340 dots
305 dpi (1 dot = 0.083 mm (0.0033"))	480 to 1248 dots	480 to 1984 dots	480 to 2010 dots
609 dpi (1 dot = 0.042 mm (0.0017"))	960 to 2496 dots	-	-

Label Length

Set the length of one piece of the media used for the head check print.

The setting range varies depending on the print resolution of the product.

The setting range is as follows:

Resolution	CL4NX Plus	CL6NX Plus
203 dpi (1 dot = 0.125 mm (0.0049"))	40 to 240 dots	40 to 240 dots
305 dpi (1 dot = 0.083 mm (0.0033"))	60 to 360 dots	60 to 360 dots
609 dpi	120 to 720 dots	-

Resolution	CL4NX Plus	CL6NX Plus
(1 dot = 0.042 mm (0.0017"))		

Pitch

Set the print position in the vertical direction.

The setting range varies depending on the print resolution of the product.

The setting range is as follows:

Resolution	CL4NX Plus	CL6NX Plus
203 dpi (1 dot = 0.125 mm (0.0049"))	-30 to 0 to 30 dots	-30 to 0 to 30 dots
305 dpi (1 dot = 0.083 mm (0.0033"))	-45 to 0 to 45 dots	-45 to 0 to 45 dots
609 dpi (1 dot = 0.042 mm (0.0017"))	-90 to 0 to 90 dots	-

When you decrease the setting value, the print position moves in the feed direction (toward the front part of the media).

When you increase the setting value, the print position moves opposite the feed direction (toward the end part of the media).

Offset

Set the stop position of the media.

The setting range varies depending on the print resolution of the product.

The setting range is as follows:

Resolution	CL4NX Plus	CL6NX Plus
203 dpi (1 dot = 0.125 mm (0.0049"))	-30 to 0 to 30 dots	-30 to 0 to 30 dots
305 dpi (1 dot = 0.083 mm (0.0033"))	-45 to 0 to 45 dots	-45 to 0 to 45 dots
609 dpi	-90 to 0 to 90 dots	-

Resolution	CL4NX Plus	CL6NX Plus
(1 dot = 0.042 mm (0.0017"))		

When you decrease the setting value, the stop position moves in the feed direction (toward the front part of the media).

When you increase the setting value, the stop position moves opposite the feed direction (toward the end part of the media).

Darkness Adjust

Fine tune the print darkness of the head check print.

0 is the lightest and 99 is the darkest.



- The value of [Label Length], [Pitch], [Offset] and [Darkness Adjust] set in the [Head Check] menu will be reflected to the same item settings in the [Factory] menu, [Configure List] menu, [Configure QR] menu and [Paper Sensor] menu.

[HEX-Dump]

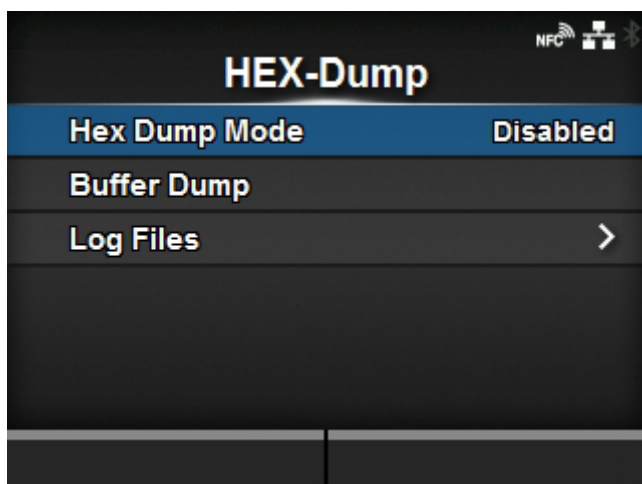

Save the hex dump print data or dump data from the receive buffer to the USB memory.

The setting items are as follows:

[Hex Dump Mode](#)

Enable or disable the Hex Dump mode.

[Buffer Dump](#)

Save the receive buffer data to the product.

[Log Files](#)

Manage the log files of the product.

[Hex Dump Mode]

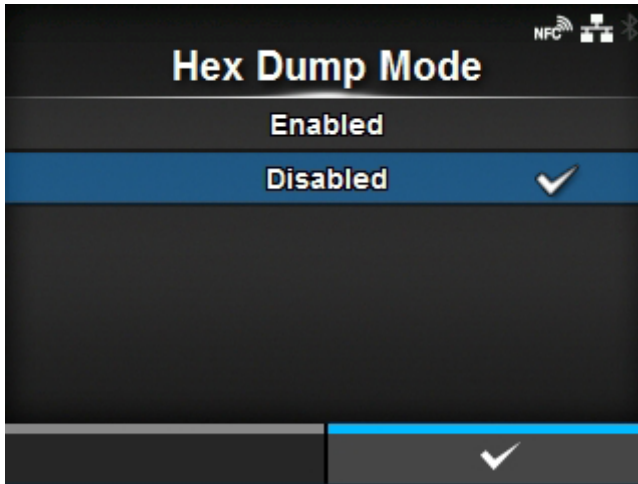

Enable or disable the Hex Dump mode.

If you set [Hex Dump Mode] to [Enabled], the product prints the received data and at the same time creates a file of the received data inside "hexdump/".

When you return the setting to [Disabled], you can check the file on the screen.



- If you set [Hex Dump Mode] to [Enabled], the icon on the Online/Offline screen changes.



Hex Dump Mode: Disabled

Hex Dump Mode: Enabled

- You can save a maximum of 10 received data files for each type of interface. Depending on the file size, the number of files you can save will be less than 10.
- The details of the files created in "hexdump/" in the product are as follows:

BT00xx.bin

Received data through Bluetooth.

LAN00xx.bin

Received data through LAN.

LPT00xx.bin

Received data through IEEE1284.

NFC00xx.bin

Received data through NFC.

PIPE00xx.bin

Received data through pipe.

SCI00xx.bin

Received data through RS-232C.

USB00xx.bin

Received data through USB.

WIFI00xx.bin

Received data through wireless LAN.

[Buffer Dump]

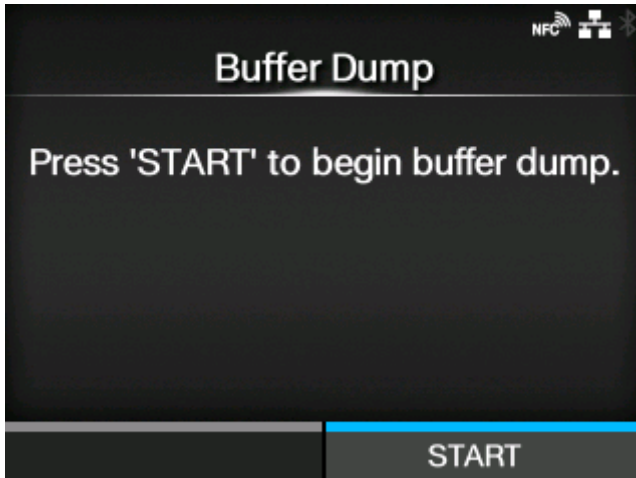

Save the receive buffer data to the product.

Available if you have set to [Disabled] in the [Hex Dump Mode] menu.

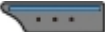
Press the [START] button ( button) on the startup screen to save the data to the product.

Save the receive buffer data to "buff/" in the product.



- The data files of the receive buffer are created for each type of interface.
- The details of the files created in "buff/" in the product are as follows:

BT0001.bin

The contents of the receive buffer for Bluetooth.

LAN0001.bin

The contents of the receive buffer for LAN.

LPT0001.bin

The contents of the receive buffer for IEEE1284.

NFC0001.bin

The contents of the receive buffer for NFC.

PIPE0001.bin

The contents of the receive buffer for pipe.

SCI0001.bin

The contents of the receive buffer for RS-232C.

USB0001.bin

The contents of the receive buffer for USB.

WIFI0001.bin

The contents of the receive buffer for wireless LAN.

- If you perform the [Buffer Dump] again, the existing file will be overwritten.
-

[Log Files]

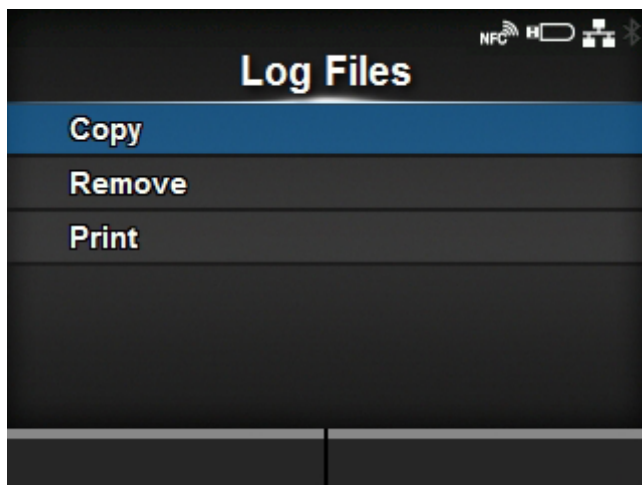

The setting items are as follows:

[Copy](#)

Copy the log files of the product to the USB memory.

- Available only if you have installed the USB memory.

[Remove](#)

Delete the log files of the product.

[Print](#)

Print a hex dump of the log files of the product.

[Copy]

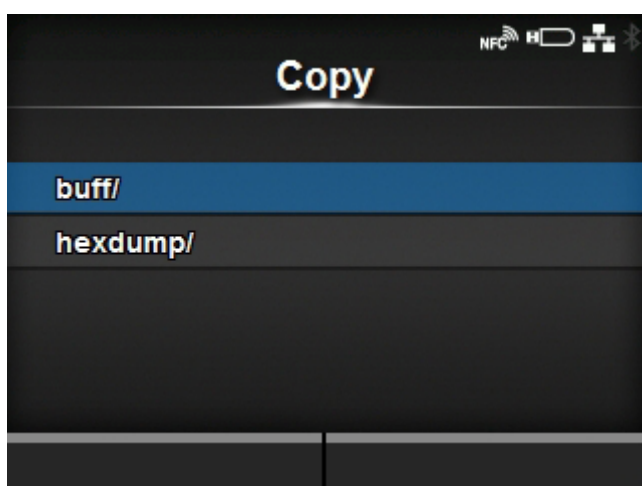



Copy the log files of the product to the USB memory.

Available only if you have installed the USB memory.



- Be sure to perform a virus check on the USB memory before connecting it to the product. SATO Corporation shall not be held responsible for any product malfunctions caused by a virus spread via USB memory.
-

The procedure to copy the log files is as follows:

1. Select the file type to copy and press the  button.
 - **buff/**
The buffer data saved when you perform the [Buffer Dump].
 - **hexdump/**
The received data created through [Hex Dump Mode].
2. Select the file to copy and press the  button. A check mark appears on the right side of the file name.

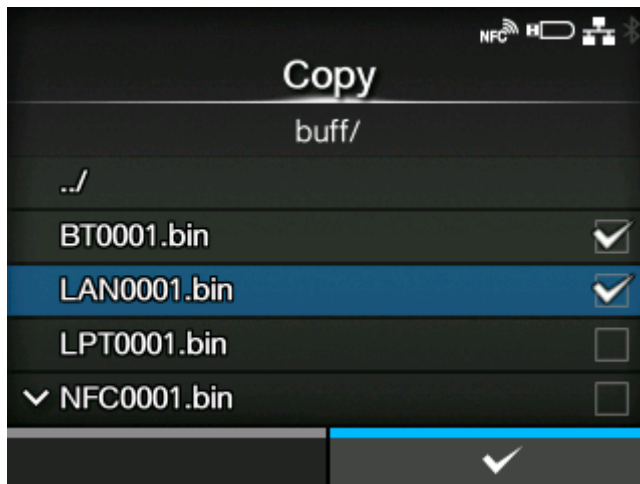

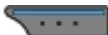
3. After you select the file, press the  button to copy the selected file to the USB memory.



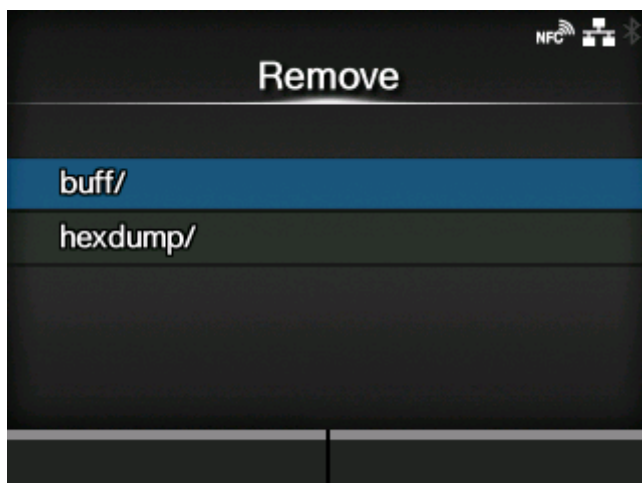

- When [Hex Dump Mode] is set to [Enabled], it may take some time before the files appear.
-

[Remove]



Delete the log files of the product.

The procedure to delete the log files is as follows:

1. Select the file type to delete and press the  button.
 - **buff/**
The buffer data saved when you perform the [Buffer Dump].
 - **hexdump/**
The received data created through [Hex Dump Mode].
2. Select the file to delete and press the  button. A check mark appears on the right side of the file name.

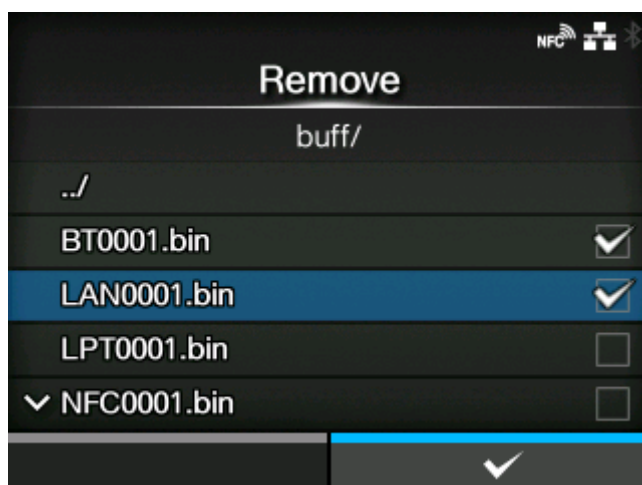

3. After you select the file, press the  button to delete the selected file.



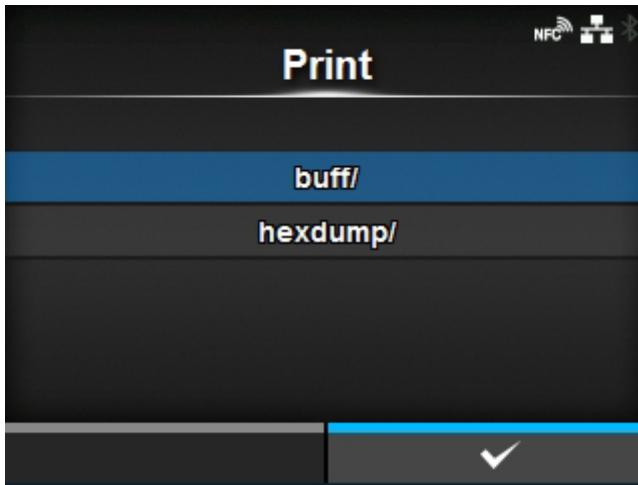

- When [Hex Dump Mode] is set to [Enabled], it may take some time before the files appear.

[Print]



Print a hex dump of the log files of the product.

The procedure to print the log files is as follows:

1. Select the file type to print and press the  button.
 - **buff/**
The buffer data saved when you perform the [Buffer Dump].
 - **hexdump/**
The received data created through [Hex Dump Mode].
2. Select the file to print and press the  button or  button to perform the dump print.

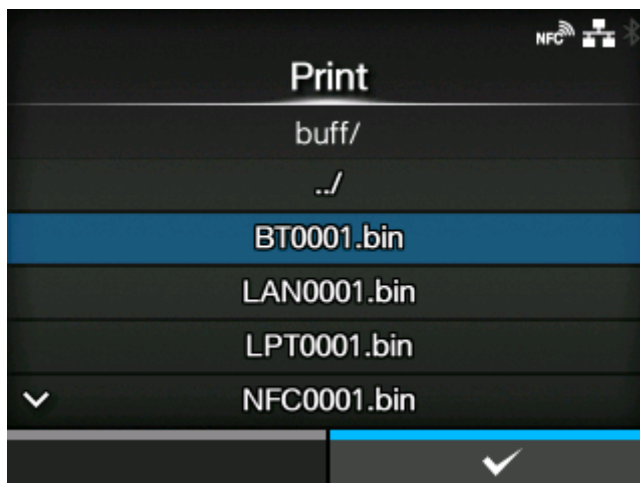

- Printing the contents of the file may use a lot of media.



- When [Hex Dump Mode] is set to [Enabled], it may take some time before the files appear.

[Reset]

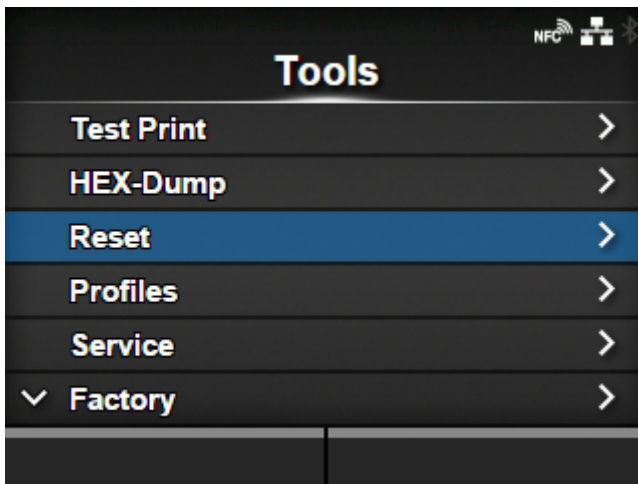

Initialize the setting values and data saved on the product.

Press  button to show the [Select] menu.

[Select]

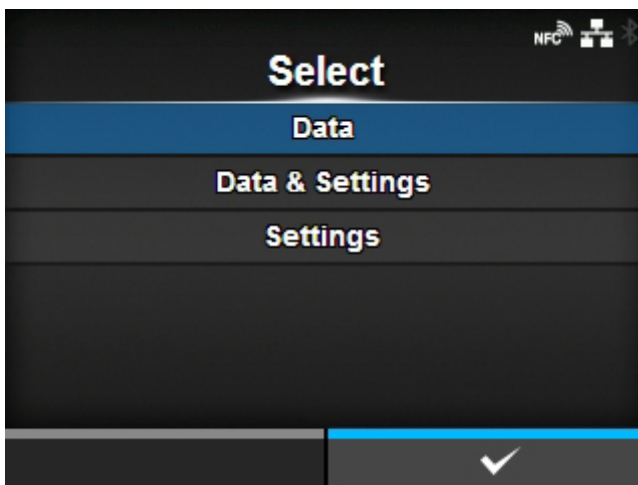

Select the items to be initialized.

The items are as follows:

[Data](#)

Initialize the data saved on the product.

[Data & Settings](#)

Initialize the data and setting values on the product.

[Settings](#)

Initialize the setting values on the product.

[Data]

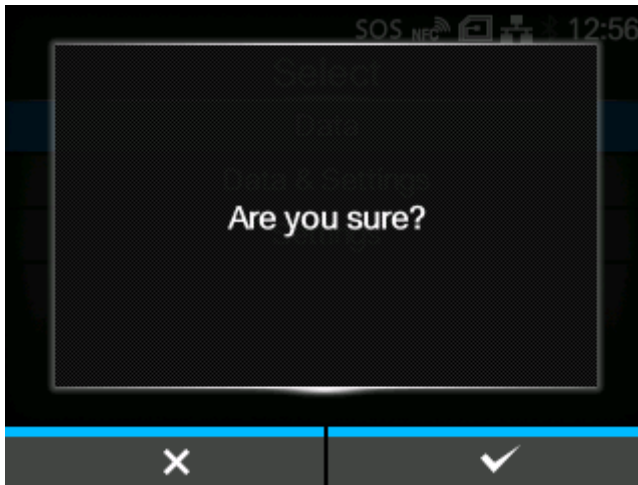

Initialize the data saved on the product.

The data to be initialized are the fonts and graphics registered in the product.

When you select [Data], the confirmation screen appears.

Press the  button to cancel or  button to perform the initialization.

The product will reboot after the initialization.



- Normally, it is not necessary to perform the initialization. Doing so could change the print conditions.

[Data & Settings]

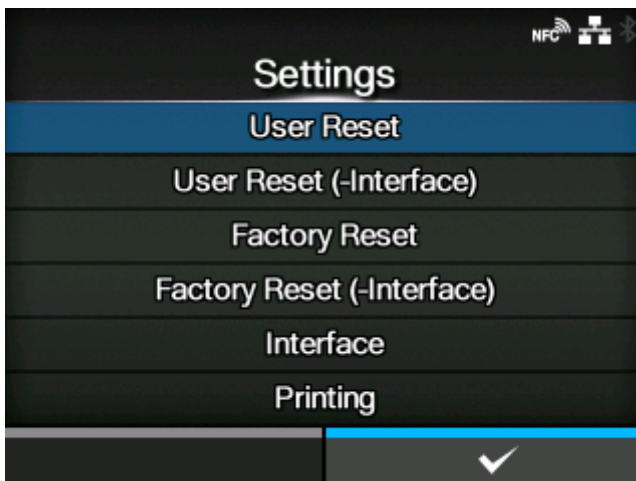

Initialize the data and setting values on the product.

Select the setting items to be initialized.

The options are as follows:

User Reset

Initialize the data and setting values.

User Reset (-Interface)

Initialize the data and setting values that are not included in the [Interface] menu.

Factory Reset

Initialize to the status after factory shipment.

Factory Reset (-Interface)

Initialize the items that are not included in the [Interface] menu to the status after factory shipment.

Interface

Initialize the data and setting values in the [Interface] menu.

Printing

Initialize the data and setting values in the [Printing] menu.

Select the item to be initialized using the ▲ / ▼ buttons and then press the ⋮ button to show the confirmation screen.

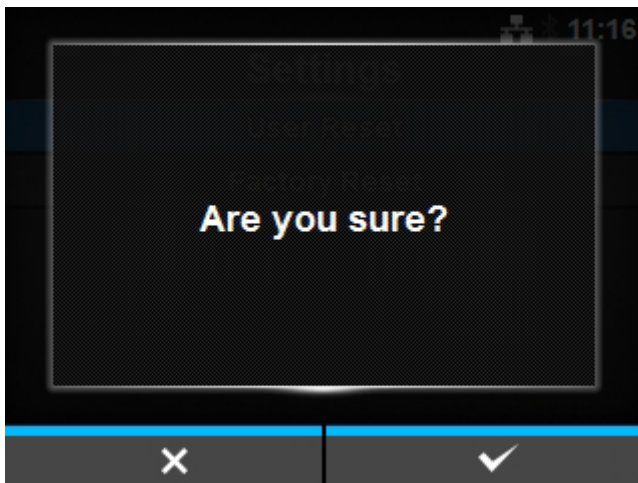

Press the ⋮ button to cancel or ⋮ button to perform the initialization.

The product will reboot after the initialization.



- The data to be initialized are the fonts and graphics registered in the product.

[Settings]

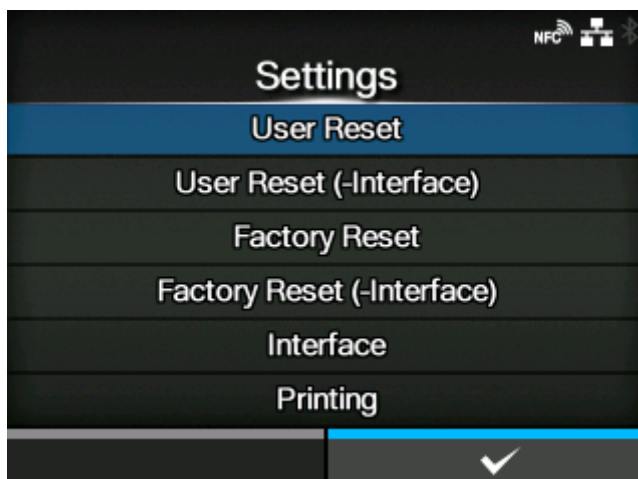

Select the setting items to be initialized.

The options are as follows:

User Reset

Initialize the setting values.

User Reset (-Interface)

Initialize the setting values that are not included in the [Interface] menu.

Factory Reset

Initialize to the status after factory shipment.

Factory Reset (-Interface)

Initialize the items that are not included in the [Interface] menu to the status after factory shipment.

Interface

Initialize the setting values in the [Interface] menu.

Printing

Initialize the setting values in the [Printing] menu.

Select the item to be initialized using the ▲ / ▼ buttons and then press the ⋮ button to show the confirmation screen.

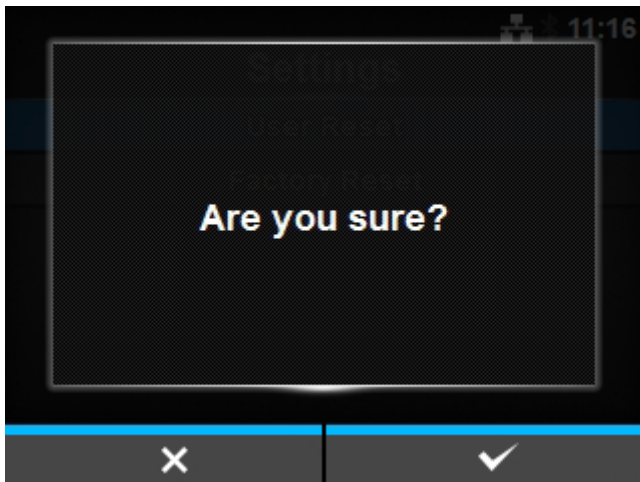

Press the ⋮ button to cancel or ⋮ button to perform the initialization.

After initialization, if a message prompting you to restart the product appears on the Online/Offline screen, reboot the product to apply the settings.

[Profiles]

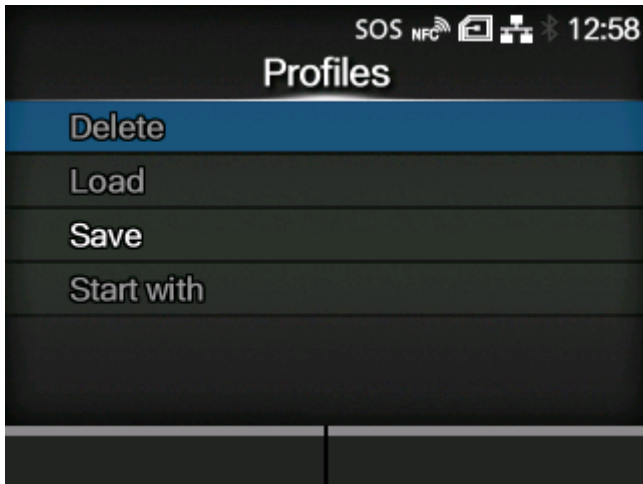

Maintain the customized profile of the product settings.

The name of the last loaded profile appears in the parentheses.

The setting items are as follows:

[Delete](#)

Delete the profile of the product.

- Not available if no profile is saved.

[Load](#)

Load the profile of the product.

- Not available if no profile is saved.

[Save](#)

Save the current product settings as a new profile.

[Start with](#)

Select the profile to be loaded at product startup.



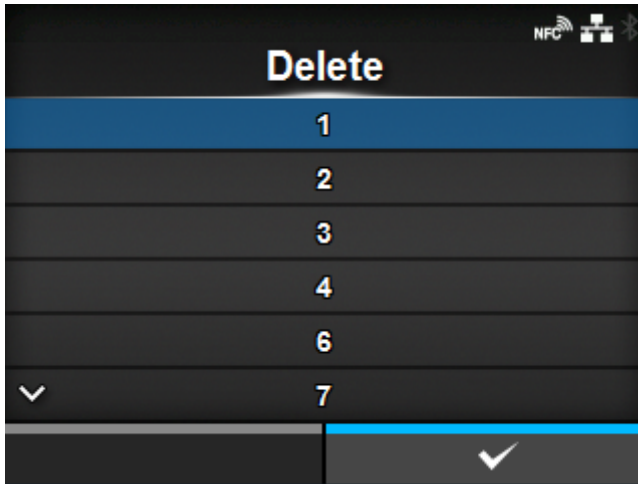

- Not available if no profile is saved.

[Delete]



Delete the profile of the product.

The procedure to delete the profile is as follows:



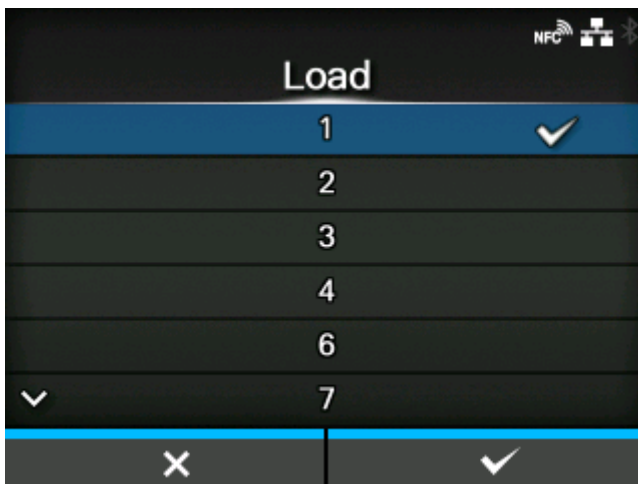

1. Select the profile to be deleted using the  /  buttons.
2. Press the  button or press the  button to confirm.
The profile name is deleted from the list.

[Load]



Load the profile of the product.

The procedure to load the profile is as follows:

1. Select the profile to be loaded using the  /  buttons.
2. Press the  button or press the  button to confirm.

A check mark appears on the right side of the loaded profile name. And the name of the loaded profile appears on the [Profiles] menu in the parentheses.

[Save]

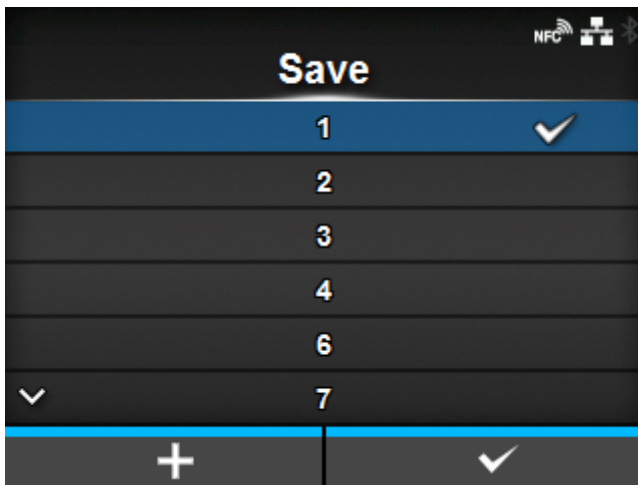

Save the current product settings as a new profile.

The screen shows a list of the profiles saved in the product. If no profile is saved, the screen shows an empty list.

To save the current product settings as a new profile, press the  button and enter the name of the profile.

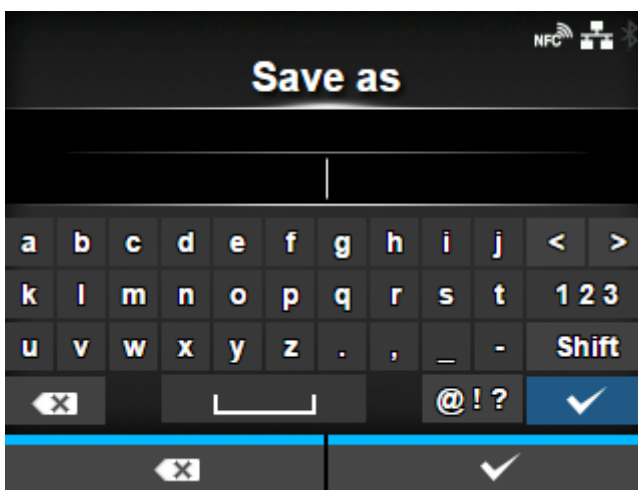

You can enter a maximum of 32 characters. You can use alphabets (capital and small letters), numbers and symbols.

Press the  button to confirm.

The new profile name appears on the list and is loaded.

[Start with]

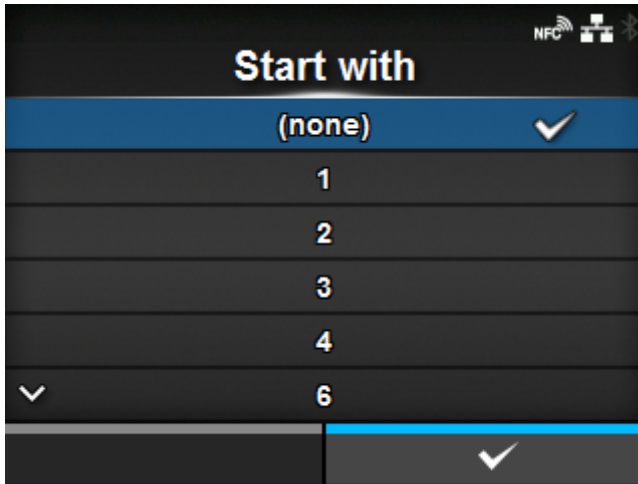

Select the profile to be loaded at product startup.

The procedure to load the profile at product startup is as follows:

1. Select the profile to be loaded at product startup using the ▲ / ▼ buttons.
2. Press the ← button or the ⋮ button to confirm.

[Certificates]

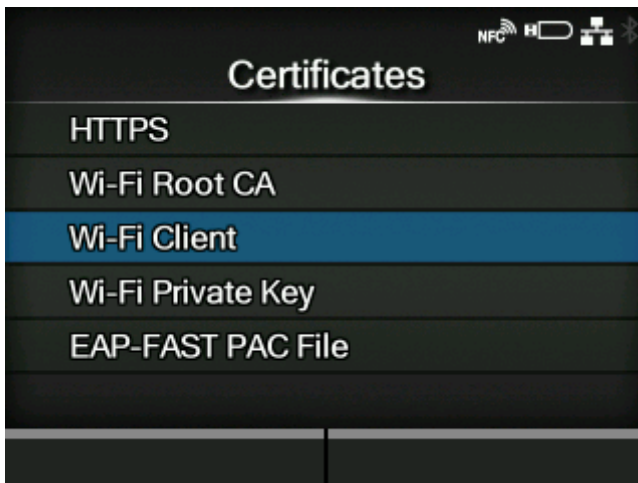

Install certificates used for Wi-Fi authentication and for HTTPS.

Available only if you have installed the USB memory.



- Be sure to perform a virus check on the USB memory before connecting it to the product. SATO Corporation shall not be held responsible for any product malfunctions caused by a virus spread via USB memory.

The setting items are as follows:

HTTPS

Installs the HTTPS certificates from the USB memory.

Wi-Fi Root CA

Installs the Wi-Fi Root CA certificates from the USB memory.

Wi-Fi Client

Installs the Wi-Fi client certificates from the USB memory.

Wi-Fi Private Key

Installs the Wi-Fi private key from the USB memory.

EAP-FAST PAC File

Installs the EAP-FAST PAC file from the USB memory.

The procedure to install the certificates and PAC files is as follows:

1. Save the certificate files to the USB thumb drive memory's root folder.
Acceptable file extensions are as follows:
 - .pem, .crt, .cer, .der for Root CA and client certificate in PEM or DER format
 - .pfx and .p12 for client certificates in PKCS #12 format
 - .prv and .key for private keys in PEM/PKCS#8 format
 - .pac for PAC files
2. Insert the USB memory into the USB connector (Type A).
3. Go to the [Settings] > [Tools] > [Certificates] menu.
4. Select the certificate you want to install. Refer to the item description above.
5. Select the certificate file from the list.

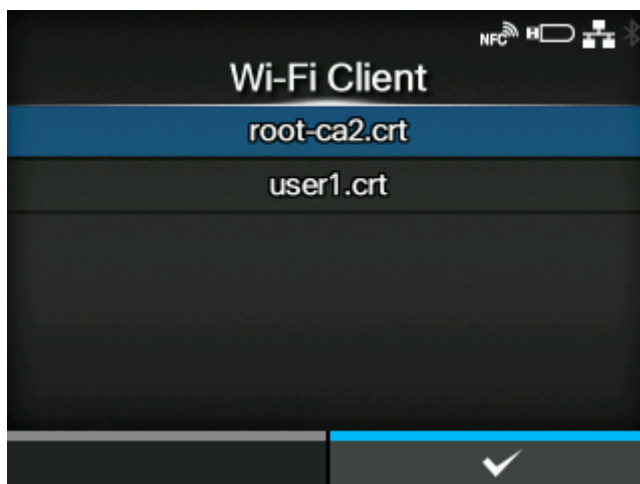

[Barcode Checker]

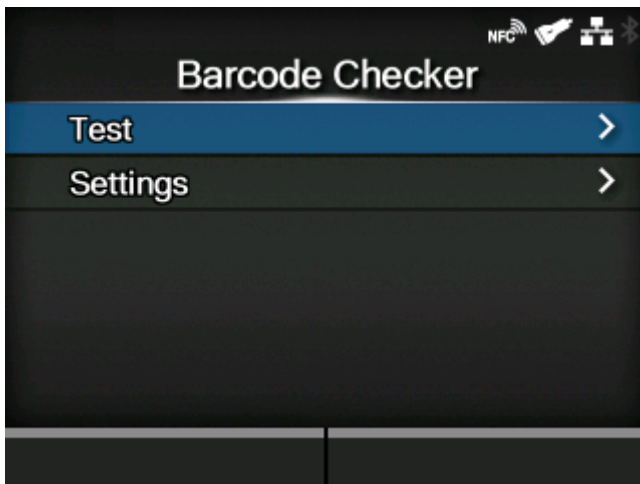

Set the barcode check function.

By connecting a barcode checker to the product, you can check the barcodes after printing.

The setting items are as follows:

[Test](#)

Set up the barcode checker.

- Available only if you have connected the barcode checker.

[Settings](#)

Set the barcode check function.



- This function cannot be used in the following conditions:
 - When the print mode is tear-off mode
 - When you are using RFID models
 - When the product is in AEP mode
 - Use the optional barcode checker stand kit to mount the barcode checker to the product. For details, refer to the Barcode Checker Stand Kit Installation Manual that came with the barcode checker stand kit.
-

[Test]

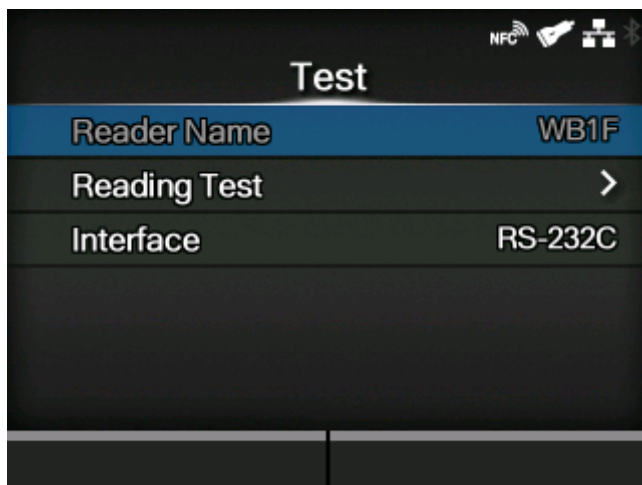

Set up the barcode checker.

Available only if you have connected the barcode checker.

The setting items are as follows:

Reader Name

Shows the barcode checker connected to the product.

Reading Test

Perform a test read with the connected barcode checker.

Interface

Set the RS-232C interface usage.

[Reading Test]

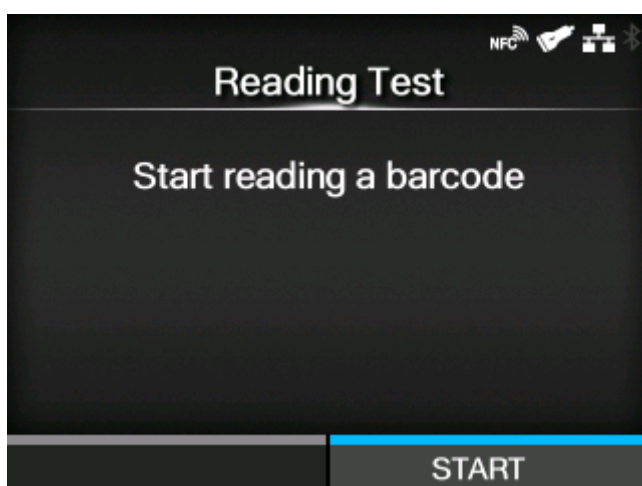

Perform a test read with the connected barcode checker.

Available only if you have connected the barcode checker.

Set a label with barcodes within the scanning range of the barcode checker, and then press the  button to start reading.

If reading is successful, the code type and read data are displayed. The data is displayed only up to 23 bytes from the beginning.

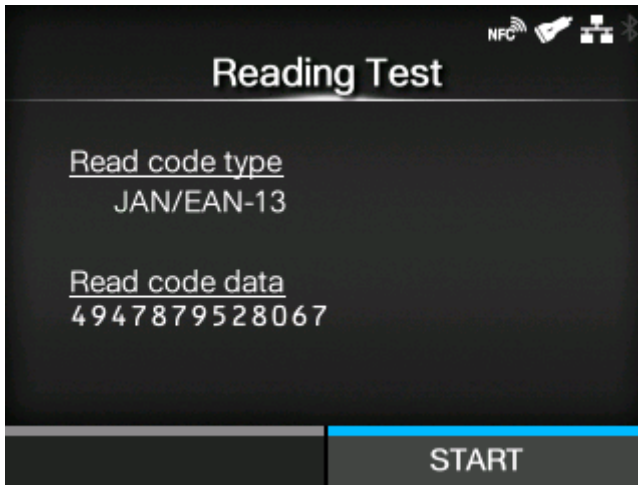

If the reading is unsuccessful, or if the displayed read result is not correct, adjust the position of the barcode checker by operating the barcode checker stand. For details on how to use the barcode checker stand, refer to the Barcode Checker Stand Kit Installation Manual that came with the barcode checker stand kit.

[Interface]

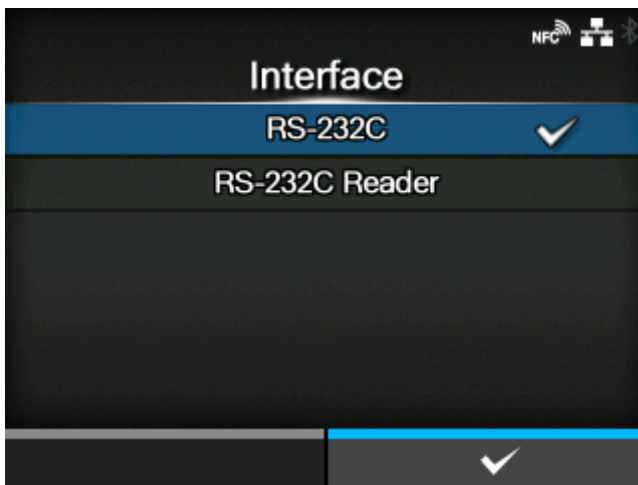

Set the RS-232C interface usage.

The options are as follows:

RS-232C

Use the RS-232C interface for communicating with computers.

RS-232C Reader

Select this when you connect the KEYENCE barcode checkers for the barcode check function.



- A message prompting you to restart the product will appear on the Online/Offline screen if you have made any changes. In such a case, reboot the product to apply the settings.

[Settings]

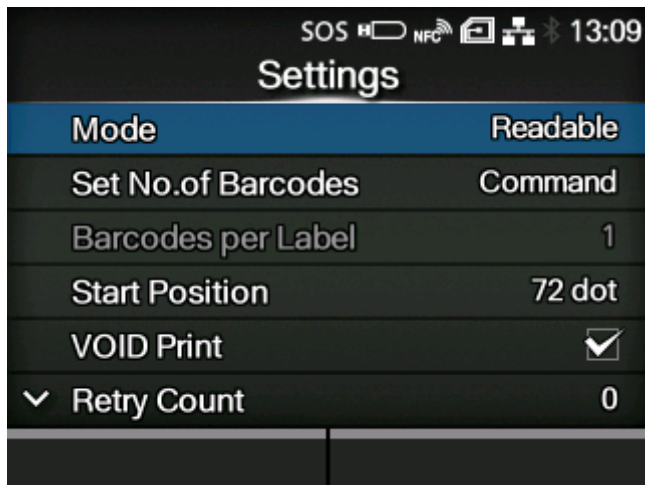

Set the barcode check function.

The setting items are as follows:

[Mode](#)

Select the check mode or disable the barcode check function.

[Set No. of Barcodes](#)

Select the method to specify the number of barcodes per label.

- Appears only if you have selected [Readable] in the [Mode] menu.

[Barcodes per Label](#)

Specify the number of barcodes per label when you include barcodes which are not created by barcode commands.

- Appears only if you have selected [Readable] in the [Mode] menu. Available only if you have selected [Settings] in the [Set No. of Barcodes] menu.

[Start Position](#)

Adjust the position at which the barcode check starts (position of the barcode checker at which reading starts).

[VOID Print](#)

Set whether to print error marks on the media when a barcode reading error or barcode comparison error occurs.

[Retry Count](#)

Set how many times the product will try to print and check the same barcode after VOID printing when a barcode reading error or barcode comparison error occurs.

- Appears only if you have selected [Enabled] in the [VOID Print] menu.

[Host Notification](#)

Set whether to return the barcode check results to the host from which the print data is sent.

[Logs](#)

Manage the barcode check log data saved in the product.

[\[Mode\]](#)

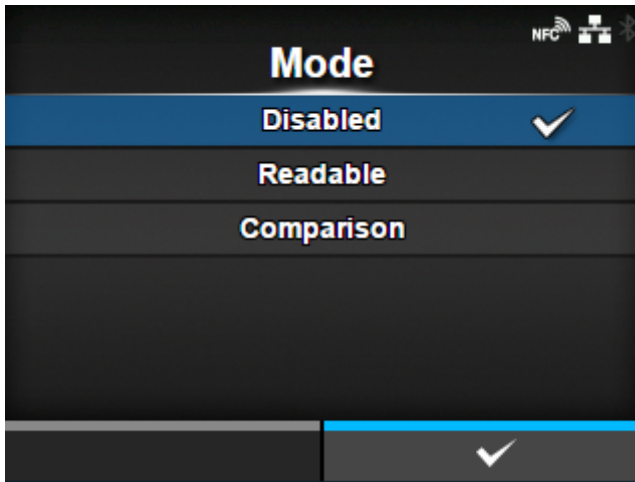

Select the check mode or disable the barcode check function.

The options are as follows:

Disabled

Disable the barcode check function.

Readable

Check if the printed barcodes are readable.

To include barcodes that are not created by barcode commands (such as graphic data or preprinted barcodes) as the target of the barcode readability check, select [Settings] in [Set No. of Barcodes], and specify the number of barcodes per label in [Barcodes per Label].

Comparison

Check if the read results of the printed barcodes match the barcode data in the print data. This mode is for barcodes created by barcode commands.

[Set No. of Barcodes]

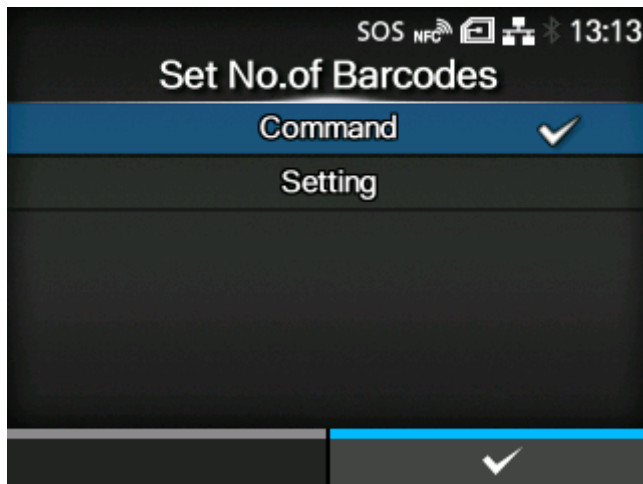

Select the method to specify the number of barcodes per label.

Appears only if you have selected [Readable] in the [Mode] menu.

The options are as follows:

Commands

Set barcodes created by barcode commands as the target of the barcode readability check.

Settings

Include barcodes that are not created by barcode commands (such as graphic data or preprinted barcodes) as the target of the barcode readability check.

You need to specify the number of barcodes per label in [Barcodes per Label].

[Barcodes per Label]

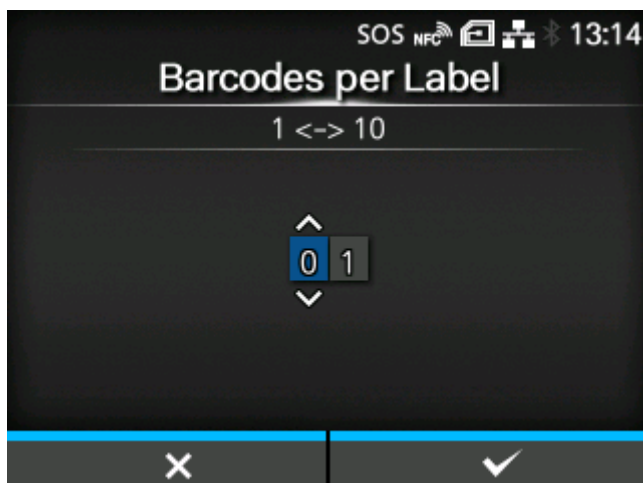

Specify the number of barcodes per label when you include barcodes which are not created by barcode commands as the target of the barcode readability check.

Appears only if you have selected [Readable] in the [Mode] menu. Available only if you have selected [Settings] in the [Set No. of Barcodes] menu.

The setting range is from 1 to 10.



- When excluding first barcode(s) from the check target by setting [Start Position], specify the number of barcodes without the excluded barcodes.

[Start Position]



Adjust the position at which the barcode check starts (position of the barcode checker at which reading starts).

The barcode checker starts reading each media after the specified length passes from the printing start position.

This setting can be used to exclude first barcode(s) from the check target when multiple barcodes are printed on each media.

The setting range varies depending on the print resolution of the product.

The setting range is as follows:

Resolution	CL4NX Plus	CL6NX Plus
203 dpi (1 dot = 0.125 mm (0.0049"))	10 to 20000 dots	10 to 20000 dots
305 dpi (1 dot = 0.083 mm (0.0033"))	15 to 18000 dots	15 to 18000 dots
609 dpi (1 dot = 0.042 mm (0.0017"))	30 to 9600 dots	-

[VOID Print]

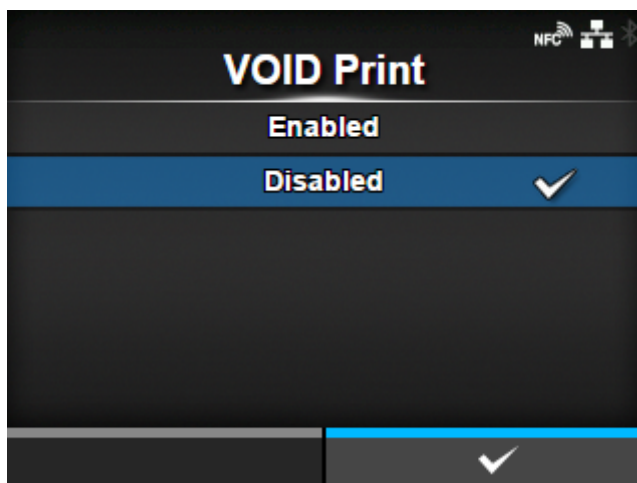

Set whether to print error marks on the media when a barcode reading error or barcode comparison error occurs.

6 x 6 mm (0.24" x 0.24") error marks are printed within the width of the print data image and in a length of up to 30 mm (1.18") from the trailing end of the label. The length varies depending on the image length of the print data and the operation mode.

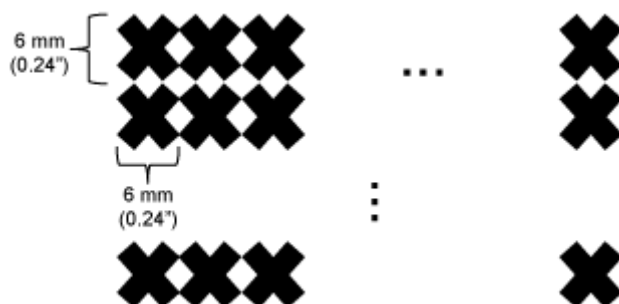

The options are as follows:

Enabled

If a reading error or comparison error occurs, the product prints error marks on the label without pausing.

After VOID printing, the product prints and checks the same label until it reaches the number of retries specified in [Retry Count]. If the error still occurs after the specified number of retries are done, the product pauses after VOID printing, and shows an error message on the display.

Disabled

If a reading error or comparison error occurs, the product pauses and shows an error message on the display.



- The VOID Print function is not supported in dispenser and linerless (CL4NX Plus only) modes.
 - The VOID Print function is not available when the length of the print data is less than 8 mm (0.31").
 - The VOID printing length becomes 4 mm (0.16") shorter when the media sensor type is set to [Gap].
 - The VOID printing length becomes 1 mm (0.04") shorter when the media sensor type is set to [I-Mark].
 - The backfeed amount of VOID printing is 30.0 mm (1.18"). However, if the image length printed on the label to be checked is less than 30.0 mm (1.18"), the backfeed amount will be the same as the image length.
 - When [VOID Print] is set to [Enabled], VOID printing is forcibly done if a comparison error occurs, even when no cutting is performed in cutter mode.
-

[Retry Count]

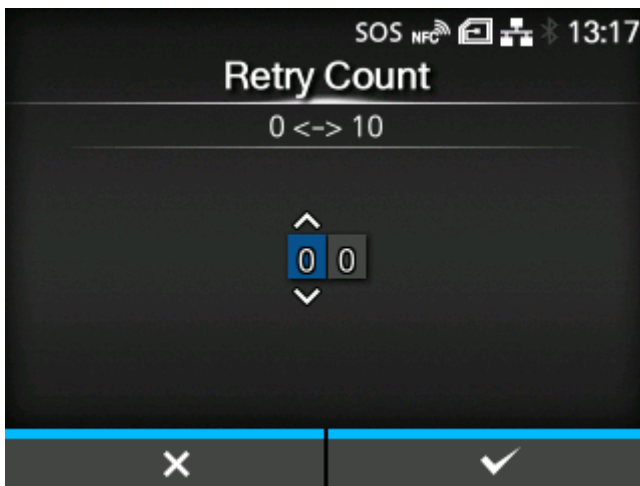

Set how many times the product will try to print and check the same barcode after VOID printing when a barcode reading error or barcode comparison error occurs.

Appears only if you have selected [Enabled] in the [VOID Print] menu.

The setting range is from 0 to 10.

As long as the error continues to occur, the label is reprinted up to the number of times specified in this setting.

For example, if you set it to 0, if the error occurs while checking the first label, the product pauses and shows an error message after VOID printing. If set to 5, if the error continues to occur until the 6th label, the product pauses after VOID printing for the 6th label, and shows an error message.

[Host Notification]

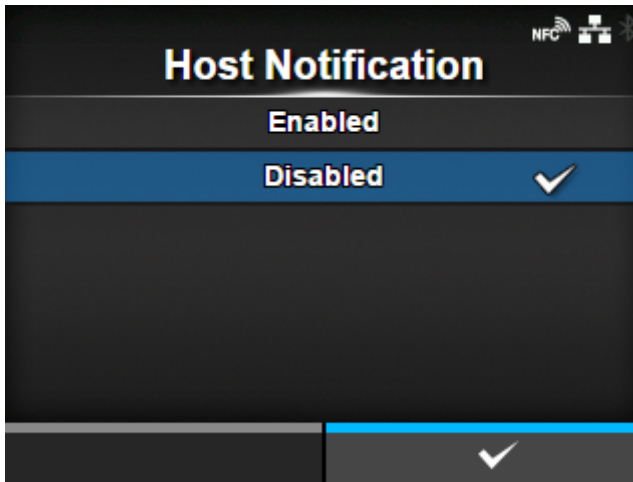

Set whether to return the barcode check results to the host from which the print data is sent.

The options are as follows:

Enabled

Return the barcode check result of each label to the host as follows:

- When the check is successful: <STX>BV, OK<ETX>
- When the check is unsuccessful: <STX>BV, NG<ETX>

Disabled

Do not return the barcode check results to the host.

[Logs]

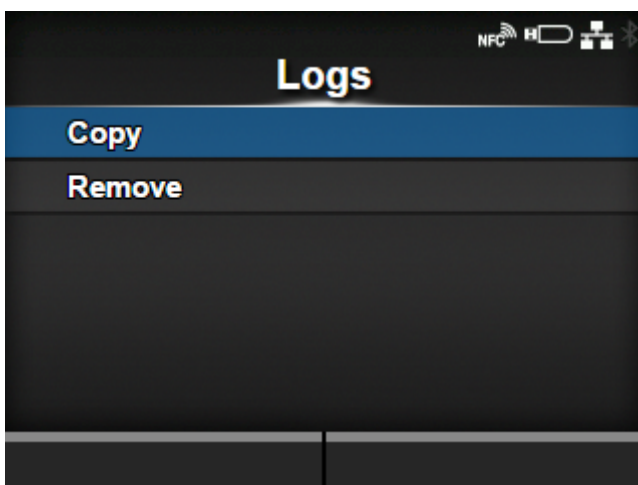

Manage the barcode check log data saved in the product.

Available only if there is barcode check log data in the product.

Note that new log data overwrites on older log data when the log file reaches its maximum size (1 MB).

The setting items are as follows:

[Copy](#)

Copy the barcode check log data to the USB memory.

- Available only if you have installed the USB memory.

[Remove](#)

Remove the barcode check log data.

Format and Contents of the Barcode Check Log Data

The barcode check log data is created in the following format:

```
YYYY/MM/DD hh:mm:ss (ZZZ) [TTTTTTT] READING[IR]:SRSR:drdr...<CR><LF>
[RRRRRRR] COMMAND[IC]:SCSC:dcdc...<CR><LF>
```

Format ID	Description	
YYYY	Year of the date when the barcode check was performed ¹	
MM	Month of the date when the barcode check was performed ¹	
DD	Day of the date when the barcode check was performed ¹	
hh	Hour of the time when the barcode check was performed ¹	
mm	Minute of the time when the barcode check was performed ¹	
ss	Second of the time when the barcode check was performed ¹	
ZZZ	Time zone ¹	
TTTTTTT	The total number of printed labels after the product is powered on. *When the total number of printed labels becomes greater than an 8-digit number, the output digit will increase.	
IR	The number of read data received after reaching the position at which the check starts. *When the check result is "IGNORED", this shows "00".	
SRSR	Size of read data (bytes)	
drdr...	Read data	
RRRRRRR	Check result	
	<table border="0"> <tr> <td>SUCCESS</td> <td> <ul style="list-style-type: none"> • In readable mode, this means everything is correct. • In comparison mode, this means that the read data and print data match. </td> </tr> </table>	SUCCESS
SUCCESS	<ul style="list-style-type: none"> • In readable mode, this means everything is correct. • In comparison mode, this means that the read data and print data match. 	

Format ID	Description	
	FAILURE	<ul style="list-style-type: none"> In readable mode, this means that the barcode checker could not read the number of printed barcode data. In comparison mode, this means that the read data and print data do not match.
	IGNORED	This means that the data is read during a period other than from the start to the end of checking, while the product is active.
IC	The amount of print data as a check target *If the check result is "IGNORED", this becomes "--".	
SCSC	Size of print data (bytes) *If the check result is "IGNORED", this becomes "----".	
dcdc...	Print data *If the check result is "IGNORED", nothing is output.	

¹ If the optional RTC kit is not installed, the system time will be output.

[Copy]

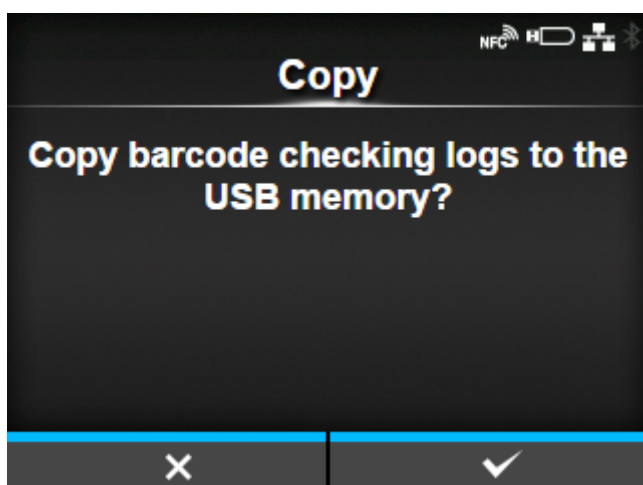

Copy the barcode check log data to the USB memory.

Available only if there is barcode check log data in the product and if you have installed the USB memory.



- Be sure to perform a virus check on the USB memory before connecting it to the product. SATO Corporation shall not be held responsible for any product malfunctions caused by a virus spread via USB memory.

Press the  button to copy the log data to the USB memory.

[Remove]

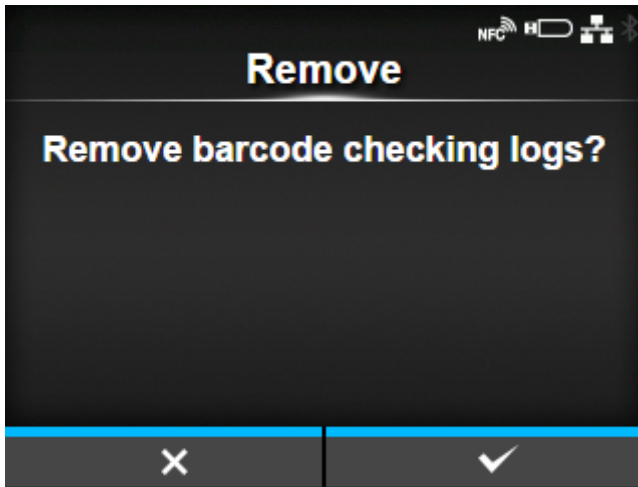

Delete the barcode check log file.

Available only if there is barcode check log data in the product.

Press the  button to delete the log data.

[Clone]

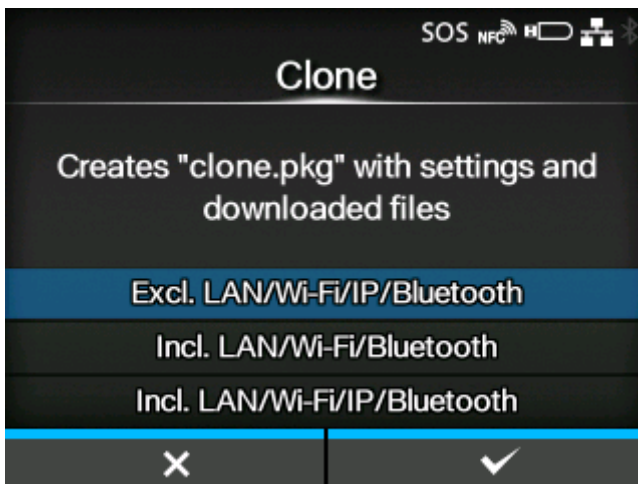

Copy the current product settings and the installed data to the USB memory.

Available only if you have installed the USB memory.



- Be sure to perform a virus check on the USB memory before connecting it to the product. SATO Corporation shall not be held responsible for any product malfunctions caused by a virus spread via USB memory.

This function is useful to transfer the settings of a product you are replacing to continue using them in a new product, or if you are setting up multiple products with the same settings.

The options are as follows:

Excl. LAN/Wi-Fi/IP/Bluetooth

Copy the product settings and data, excluding network information and Bluetooth device name, to the USB memory. This is useful when you set up multiple products, that are already connected to a network, with the same settings.

Incl. LAN/Wi-Fi/Bluetooth

Copy the product settings and data, including network information (excluding the IP address) and Bluetooth device name, to the USB memory. This is useful when you set up multiple products to be connected to the same network with the same settings.

Incl. LAN/Wi-Fi/IP/Bluetooth

Copy the product settings and data, including network information (including the IP address) and Bluetooth device name, to the USB memory. This is useful when transferring the settings of a product you are replacing to continue using them in a new product.

[Support Info]



Save various information about the product, such as attached options, serial number, application versions and settings configuration, in a text file (.txt) to the USB memory.

Available only if you have installed the USB memory.



- Be sure to perform a virus check on the USB memory before connecting it to the product. SATO Corporation shall not be held responsible for any product malfunctions caused by a virus spread via USB memory.

By selecting [Support Info] and pressing the  button, the support information is saved to the USB memory.

After saving is complete, the saved location is displayed.

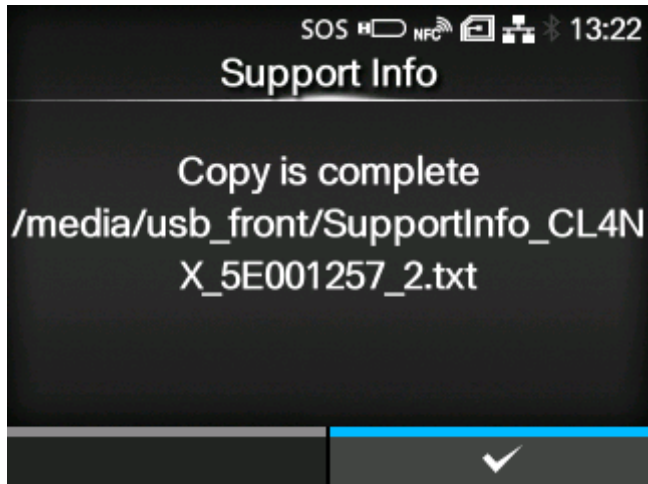

Press the  button to complete.

[Logging Function]

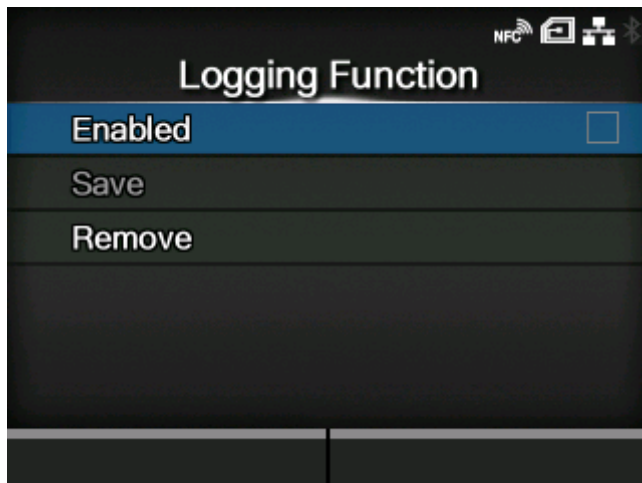

Save the log data.

The setting items are as follows:

[Enabled](#)

Enable or disable the logging function.

[Save](#)

Save the log data to the USB memory.

[Remove](#)

Delete the log data.

[Enabled]

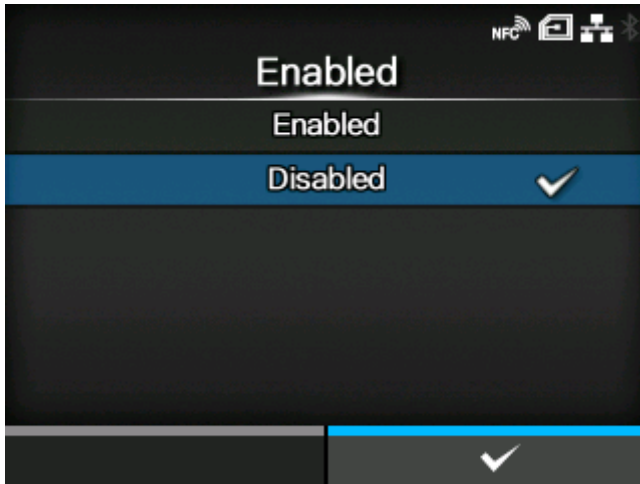

Enable or disable the logging function.

The options are as follows:

Enabled

Enable the logging function. When this function is enabled, the log data is saved when powering off the product.

Disabled

Disable the logging function.



- When this function is enabled, log data is saved when powering off, so it may take some time to power off the product. Wait until the product is powered off.
 - While the log data is being saved, a red message that says "Log Saving" appears on the screen.
 - The product stores log data for the last five times the product was powered off.
 - The types of log data that are saved are as follows:
 - Key events
 - Analysis status
 - System logs and settings
 - Shared memory (including receive buffer)
 - Operational logs for the barcode scanner
-

[Save]

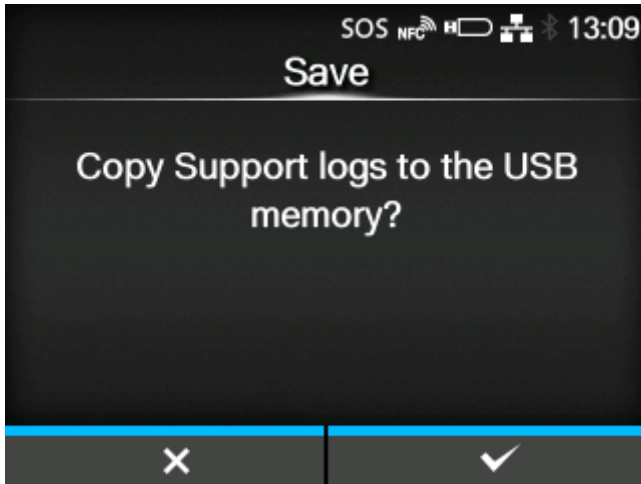

Save the log data to the USB memory.

Available only if there is log data in the product and if you have installed the USB memory.



- Be sure to perform a virus check on the USB memory before connecting it to the product. SATO Corporation shall not be held responsible for any product malfunctions caused by a virus spread via USB memory.

Press the  button to copy the log data to the USB memory.



- The saved log data is strictly for the use of SATO authorized service personnel.

[Remove]

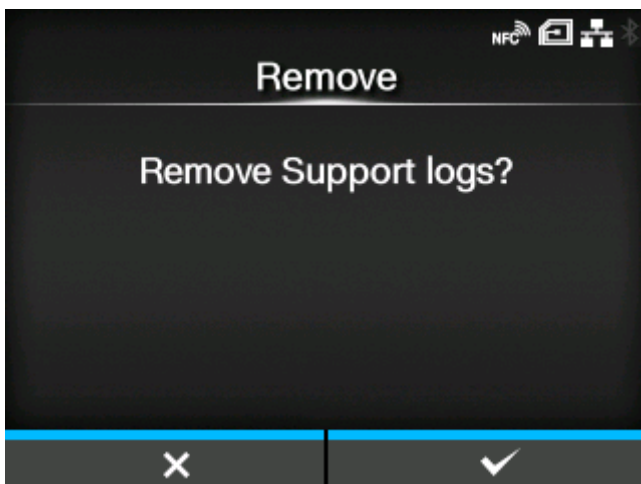

Press the  button to delete the log data.

[Startup Guide]

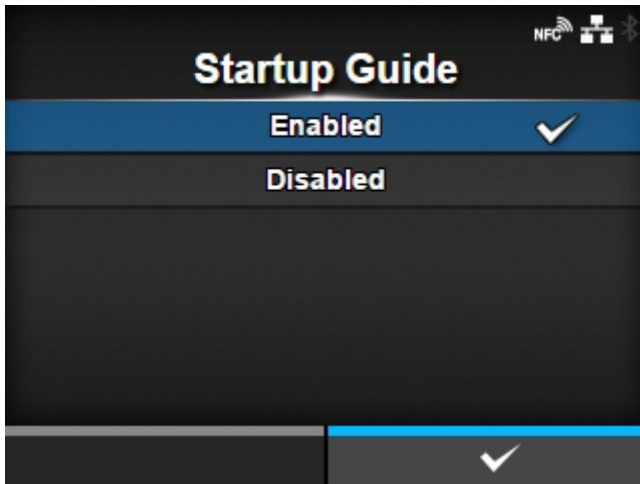

The startup guide is a function to help you through the initial product settings (such as setting date and time, and loading the ribbon and media).

Enable or disable the startup guide.

The options are as follows:

Enabled

Enable the startup guide.

Disabled

Disable the startup guide.

If you have selected [Enabled], the startup guide appears when you power on the product.



[Information] Menu

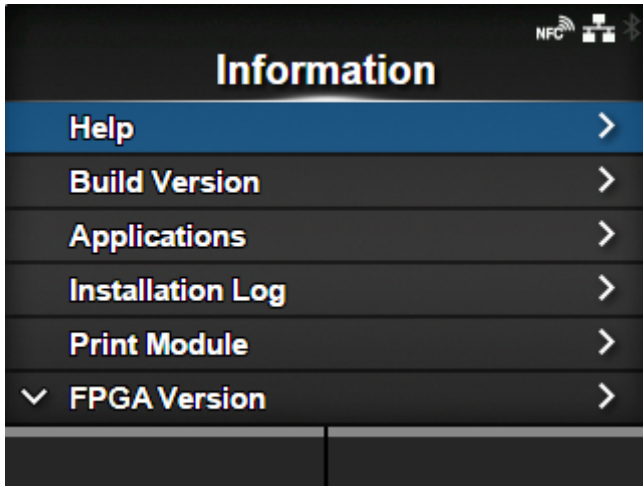

The following settings are available in the [Information] menu:

[Help](#)

Shows the guidance video.

[Build Version](#)

Shows the firmware version.

[Applications](#)

Shows various application versions.

[Installation Log](#)

Shows the installation log data.

- Appears only if there is log data in the product.

[Print Module](#)

Shows the print module information.

[FPGA Version](#)

Shows the FPGA version.

[Counters](#)

Shows the counter information.

[IPv4 Address](#)

Shows the IPv4 address.

[IPv6 Address](#)

Shows the IPv6 address.

- Does not appear when Wi-Fi Direct is active.

[LAN MAC](#)

Shows the MAC address of the LAN.

- Appears only if the LAN interface is selected.

[Wi-Fi MAC](#)

Shows the MAC address of the wireless LAN.

- Appears only if the optional wireless LAN is installed and the Wi-Fi interface is selected.

[Wi-Fi Region](#)

Shows the region information of the wireless LAN.

- Appears only if the optional wireless LAN is installed and the Wi-Fi interface is selected.

[Wi-Fi Status](#)

Shows the status of the wireless LAN.

- Appears only if the optional wireless LAN is installed and the Wi-Fi interface is selected.

[Wi-Fi Direct](#)

Shows the connection information of Wi-Fi Direct.

- Appears only if connected using Wi-Fi Direct.

[Wi-Fi Versions](#)

Shows the version of the wireless LAN.

- Appears only if the optional wireless LAN is installed and the Wi-Fi interface is selected.

[Wi-Fi Module](#)

Shows the name of the installed wireless LAN module.

- Appears only if the optional wireless LAN is installed and the Wi-Fi interface is selected.

[Help]

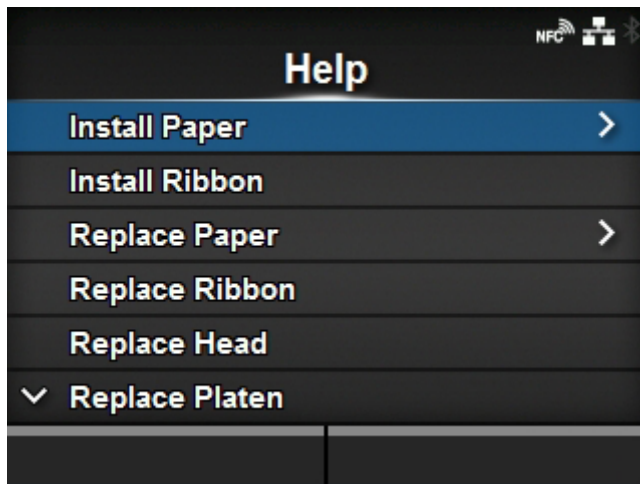

Shows the guidance video.

You can view the video for loading the media and ribbon, the cleaning method and replacement method of consumables.

The list of videos are as follows:

[Install Paper](#)

Shows the video for loading the media.

[Install Ribbon](#)

Shows the video for loading the ribbon.

[Replace Paper](#)

Shows the video for replacing the media.

[Replace Ribbon](#)

Shows the video for replacing the ribbon.

[Replace Head](#)

Shows the video for replacing the print head.

[Replace Platen](#)

Shows the video for replacing the platen roller.

[Cleaning](#)

Shows the video of the cleaning method.

[Install Paper]

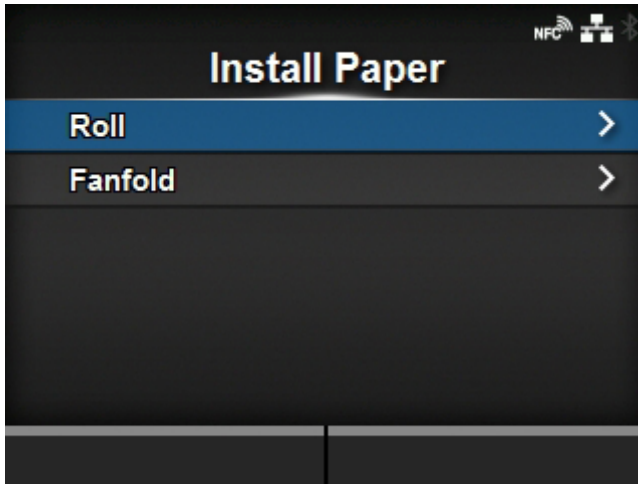

Shows the video for loading the media.

The items are as follows:

[Roll](#)

Shows the video for loading the media roll.

[Fanfold](#)

Shows the video for loading the fan-fold media.

[Roll]

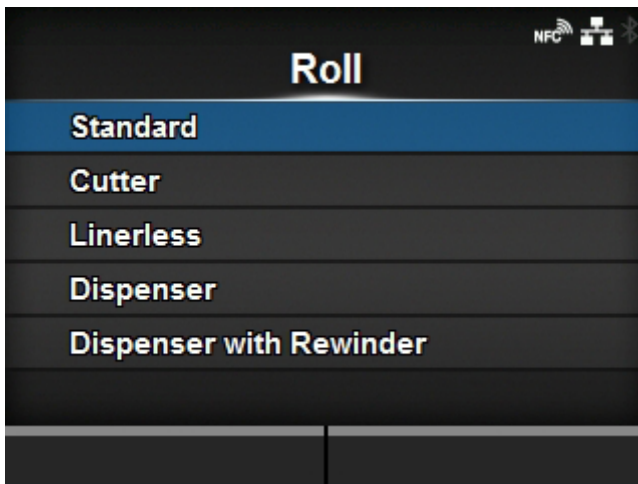

Shows the video for loading the media roll.

The items are as follows:

[Standard](#)

Shows the video for loading the media roll to a standard product.

[Cutter](#)

Shows the video for loading the media roll to a product installed with a cutter.

Linerless

(CL4NX Plus only)

Shows the video for loading the media roll to a product installed with a linerless cutter kit.

Dispenser

Shows the video for loading the media roll to a product installed with a dispenser.

Dispenser with Rewinder

Shows the video for loading the media roll to a product installed with a dispenser and liner rewinder.



- If you select [Cutter] on the product while the optional rotary cutter unit is installed, the procedure for the product with the rotary cutter unit installed will be shown. If other options have been installed or if no option has been installed, the procedure for the product with the optional cutter unit installed will be shown.
-

[Fanfold]

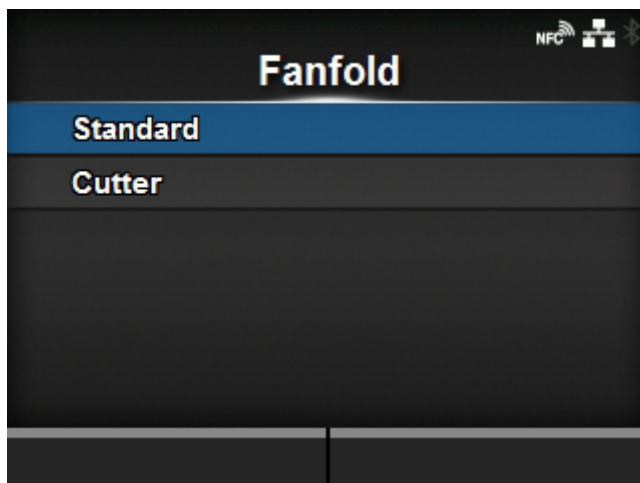

Shows the video for loading the fan-fold media.

The items are as follows:

Standard

Shows the video for loading the fan-fold media to a standard product.

Cutter

Shows the video for loading the fan-fold media to a product installed with a cutter.



- If you select [Cutter] on the product while the optional rotary cutter unit is installed, the procedure for the product with the rotary cutter unit installed will be shown. If other options have been installed or if no option has been installed, the procedure for the product with the optional cutter unit installed will be shown.
-

[Replace Paper]



Shows the video for replacing the media.

The items are as follows:

[Roll](#)

Shows the video for replacing the media roll.

[Fanfold](#)

Shows the video for replacing the fan-fold media.

[Roll]

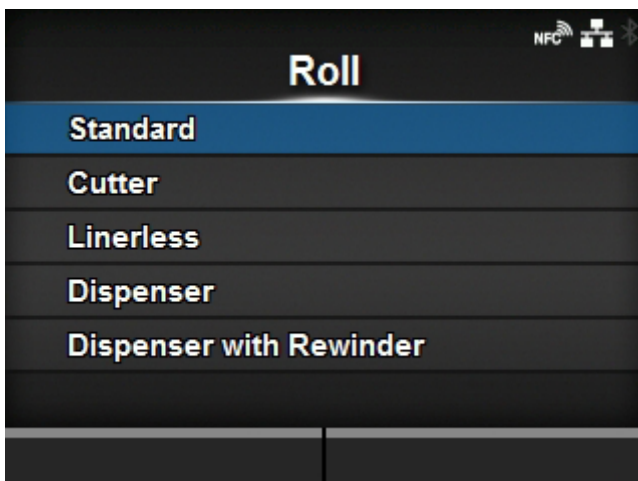

Shows the video for replacing the media roll.

The items are as follows:

[Standard](#)

Shows the video for replacing the media roll in a standard product.

[Cutter](#)

Shows the video for replacing the media roll in a product installed with a cutter.

Linerless

(CL4NX Plus only)

Shows the video for replacing the media roll in a product installed with a linerless cutter kit.

Dispenser

Shows the video for replacing the media roll in a product installed with a dispenser.

Dispenser with Rewinder

Shows the video for replacing the media roll in a product installed with a dispenser and liner rewinder.



- If you select [Cutter] on the product while the optional rotary cutter unit is installed, the procedure for the product with the rotary cutter unit installed will be shown. If other options have been installed or if no option has been installed, the procedure for the product with the optional cutter unit installed will be shown.
-

[Fanfold]



Shows the video for replacing the fan-fold media.

The items are as follows:

Standard

Shows the video for replacing the fan-fold media in a standard product.

Cutter

Shows the video for replacing the fan-fold media in a product installed with a cutter.



- If you select [Cutter] on the product while the optional rotary cutter unit is installed, the procedure for the product with the rotary cutter unit installed will be shown. If other options have been installed or if no option has been installed, the procedure for the product with the optional cutter unit installed will be shown.
-

[Build Version]

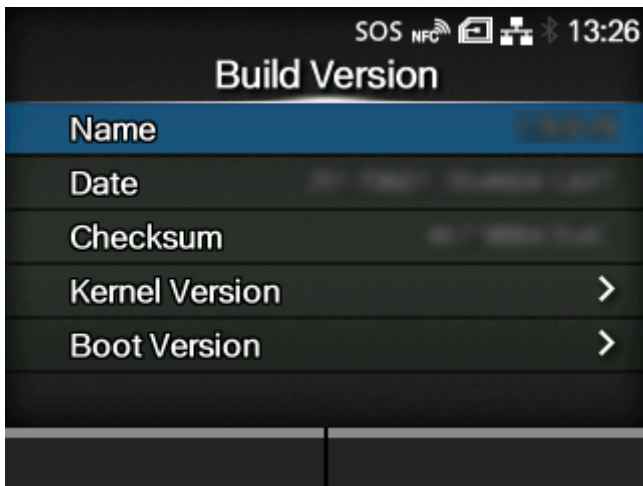

Shows the information and version of the product.

Name

Shows the name of the build version.

Date

Shows the build date.

Checksum

Shows the checksum of the build version.

Kernel Version

Shows the kernel version.

Boot Version

Shows the boot version.

[Kernel Version]

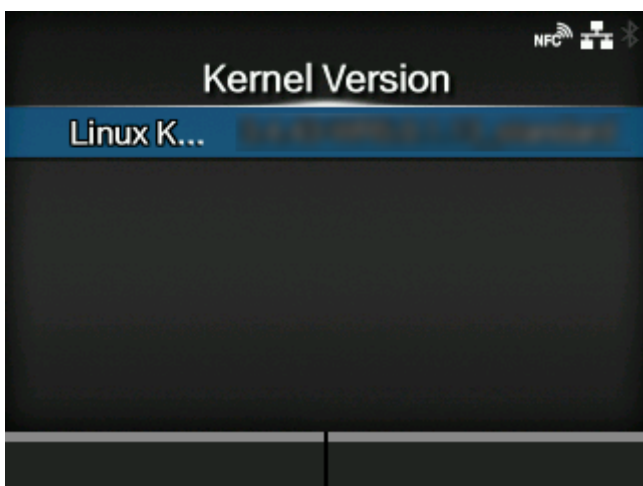

Shows the kernel version of the product.

[Boot Version]

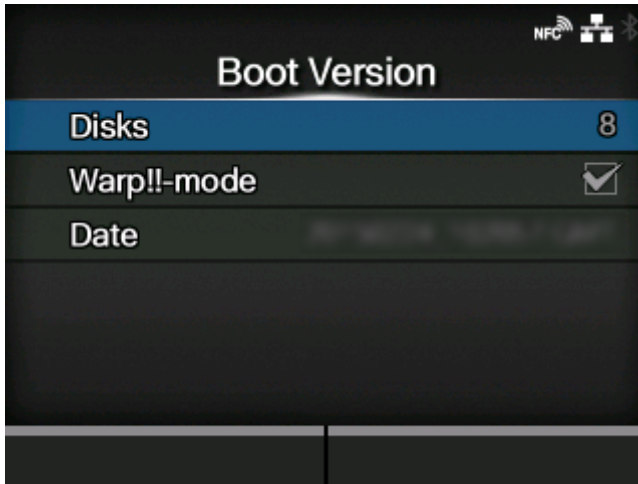

Shows the boot version of the product.

The items are as follows:

Disks

Shows the Disks.

Warp!!-mode

A checked box means enabled. An unchecked box means disabled.

Date

Shows the build date of the boot version.

[Applications]

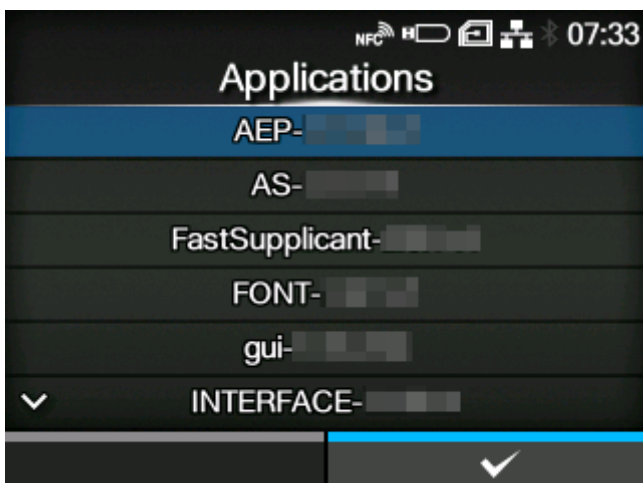

Shows the versions of the applications installed in the product, such as printer languages.

[Installation Log]

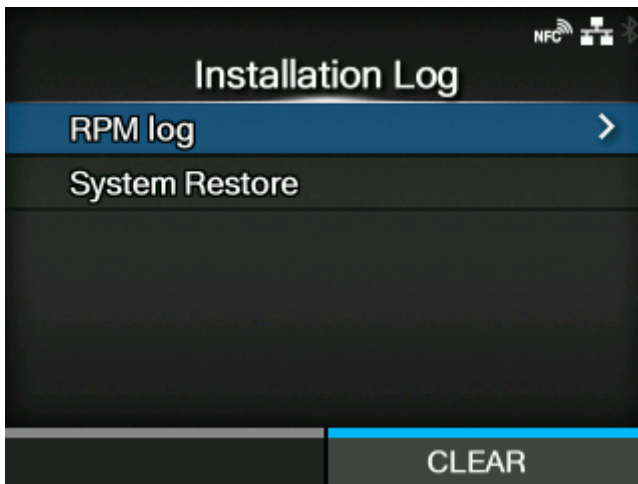

Show or clear the installation log data in the product.

The setting items are as follows:

[RPM log](#)

Shows the RPM log data.

[System Restore](#)

Shows the system restore log data.

Press the  button (CLEAR) to clear the selected log data.



- This screen does not appear if there is no log data in the product.

[RPM log]



Shows a list of RPM log files containing three sections: installed, updated and obsolete.

The RPM log file is created after installing a pkg-file containing rpm-files.

[System Restore]



Shows the system restore log.

The system restore log file is created after installing a pkg-file that caused a state in which the product's operator panel cannot be operated.

[Print Module]

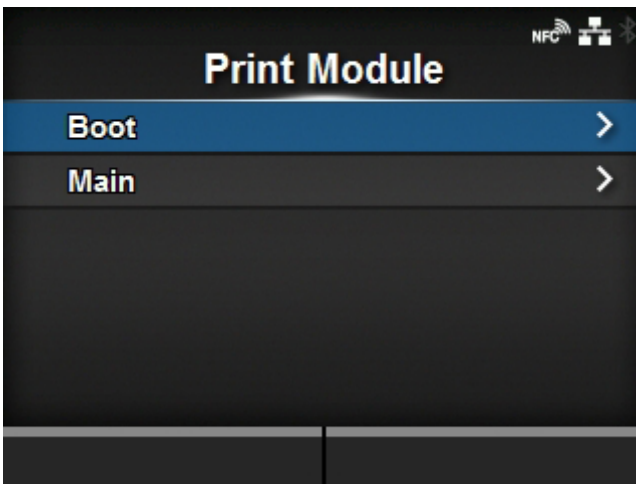

Shows information about the print module on the product.

The items are as follows:

[Boot](#)

Shows the Boot firmware version.

[Main](#)

Shows the Main firmware version.

[Boot]

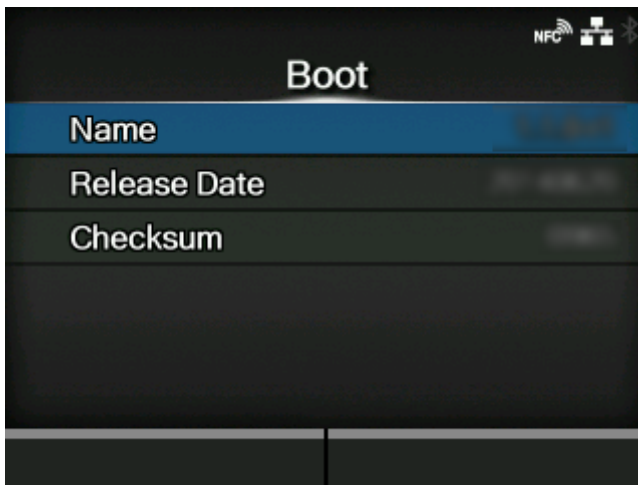

Name

Shows the Boot firmware version.

Release Date

Shows the Boot firmware release date.

Checksum

Shows the Boot firmware checksum.

[Main]

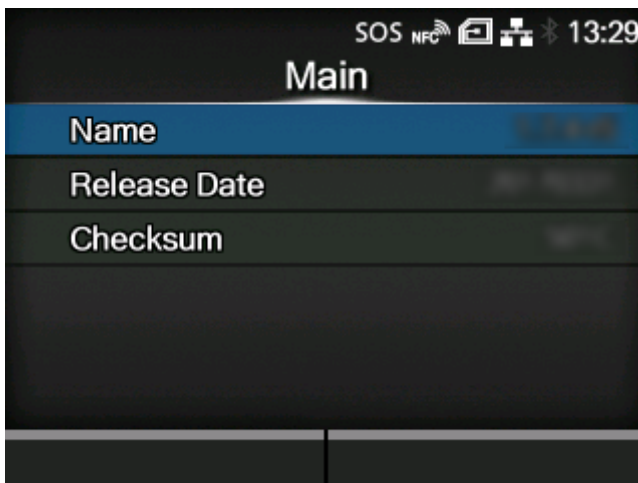

Name

Shows the Main firmware version.

Release Date

Shows the Main firmware release date.

Checksum

Shows the Main firmware checksum.

[FPGA Version]

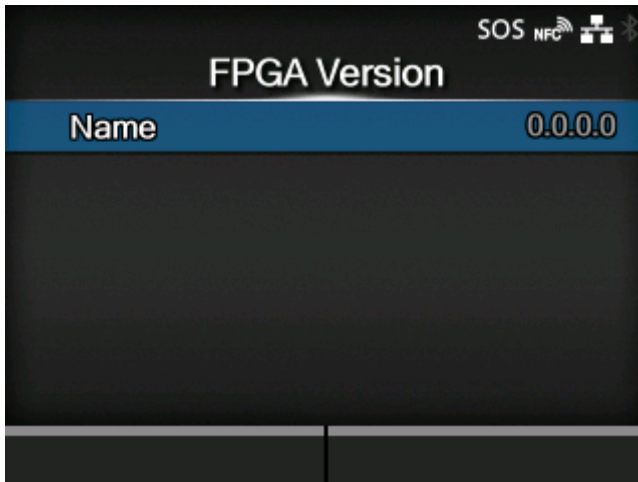

Shows the FPGA version on the product.

The item is as follows:

Name

Shows the FPGA version.

[Counters]

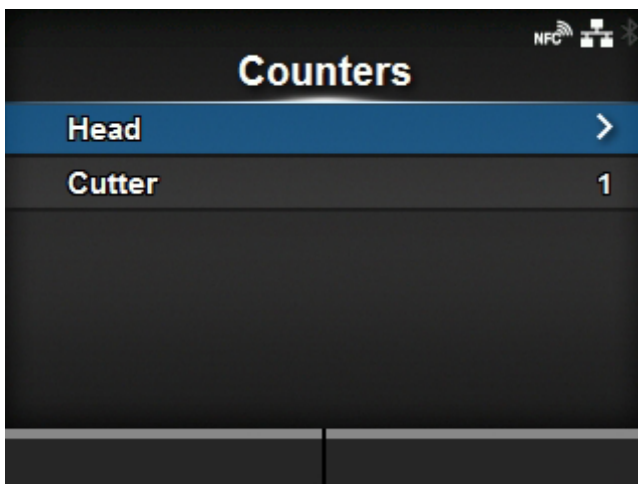

Shows information about the counters on the product.

The setting items are as follows:

Head

Shows information about the head counter on the product.

Cutter

Shows the current number of cuts.



- Only SATO authorized service personnel are permitted to clear the counter.

[Head]

Head	
Life	19.2 m
Head 1	12.8 m
Head 2	0 m
Head 3	0 m

Shows information about the head counter on the product.

Life

Shows the current print distance.

Head 1Head 2Head 3

The current print distance is shown in [Head 1]. When you replace the print head and the counter is cleared, the value of [Head 2] appears in [Head 3] and the value of [Head 1] appears in [Head 2]. [Head 1] will start to count from 0 again.

[IPv4 Address]

IPv4 Address	
0.0.0.0	

Shows the IPv4 address.

[IPv6 Address]

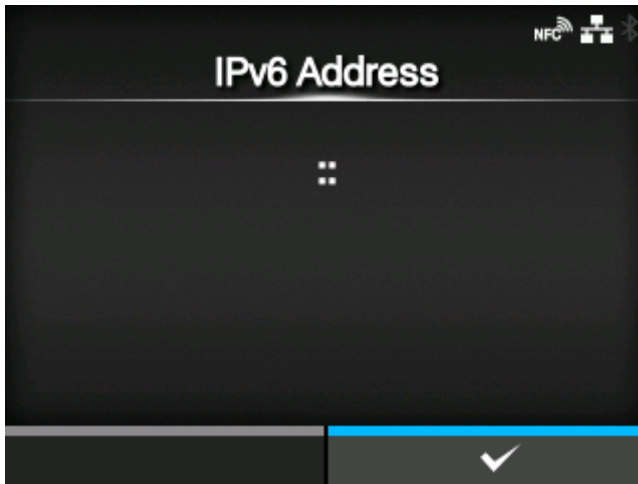

Shows the IPv6 address.



- When Wi-Fi Direct is active, this IPv6 address screen does not appear.

[LAN MAC]

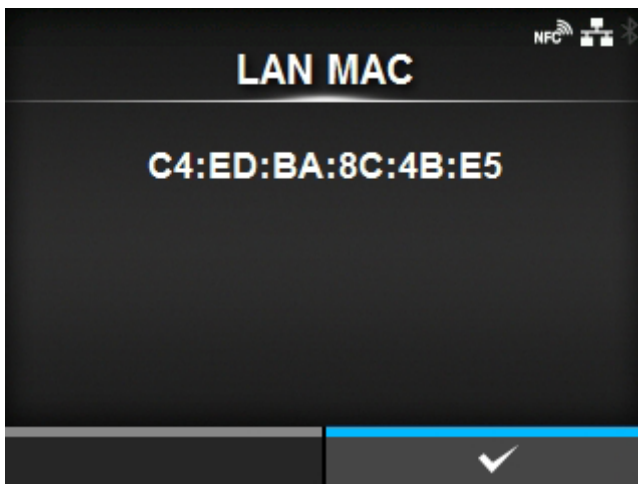

Shows the MAC address of the LAN.

Appears only if LAN is the active interface.

[Wi-Fi MAC]



Shows the MAC address of the wireless LAN.

Appears only if you have installed the optional wireless LAN and Wi-Fi is the active interface.

[Wi-Fi Region]

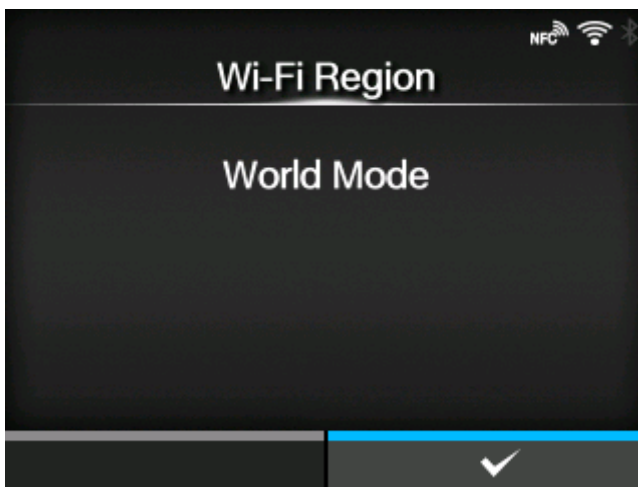

Shows the region information of the wireless LAN.

Appears only if you have installed the optional wireless LAN and Wi-Fi is the active interface.

[Wi-Fi Status]

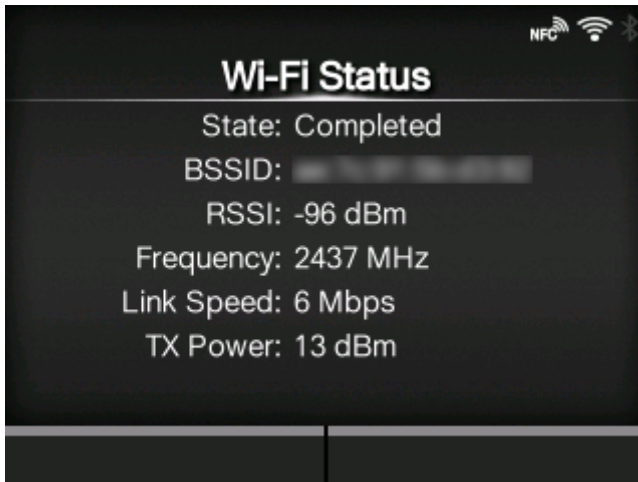

Shows the status of the wireless LAN.

Appears only if you have installed the optional wireless LAN and Wi-Fi is the active interface.

[Wi-Fi Direct]



Shows the connection information of Wi-Fi Direct.

Appears only if Wi-Fi Direct is the active interface and you are connected using Wi-Fi Direct.

[Wi-Fi Versions]

When the installed wireless LAN module is W-LAN2¹



When the installed wireless LAN module is W-LAN1¹

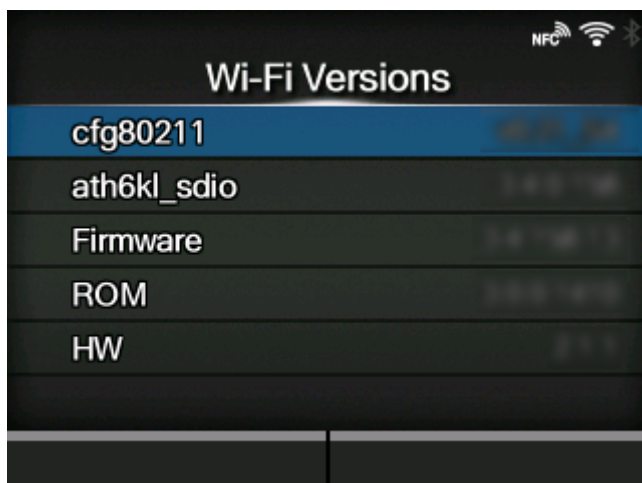

Shows the version of the wireless LAN.

Appears only if you have installed the optional wireless LAN and Wi-Fi is the active interface.

¹ The installed wireless LAN module is displayed in [Wi-Fi Module] in the [Information] menu.

[Wi-Fi Module]

When the installed wireless LAN module is W-LAN2



When the installed wireless LAN module is W-LAN



Shows the name of the installed wireless LAN module.

Appears only if the optional wireless LAN is installed and the Wi-Fi interface is selected.

Configuring the Product Settings from a Web Browser

Accessing to the Web Configuration Page

The product can be operated through a web configuration page using any browser.

With an Ethernet LAN or WLAN connection, users can remotely get information from the product or perform the product settings.



- You need the product's IP address to access the web configuration page. The product's IP address can be checked in [Settings] > [Information] > [IPv4 Address].
- If the product's [Settings] > [Interface] > [Network] > [Advanced] > [Firewall] > [Enable] menu is set to [Enabled], [Settings] > [Interface] > [Network] > [Advanced] > [Firewall] > [Allow Services And Ports] > [WebConfig] must be set to [Enabled].

1. Open up the browser and enter the product's URL.

If the product's IP address is 192.168.143.123, enter the following URL: https://192.168.143.123

When a security certificate is prompted, you must acknowledge and click Continue.

The web configuration page for the product appears. On the upper right (1) of each page, the model name, current resolution and MAC address are shown.

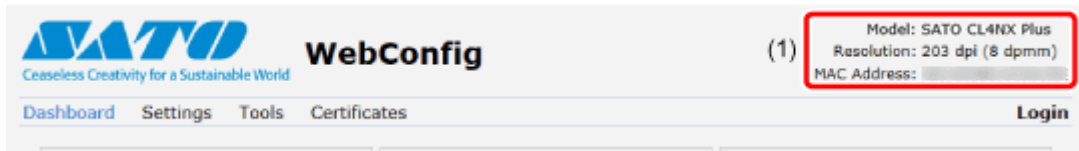

2. Log in to view the [Settings] and [Tools] pages.

You can view [Dashboard] and [Certificates] pages without logging in.

- Click [Login] (2).

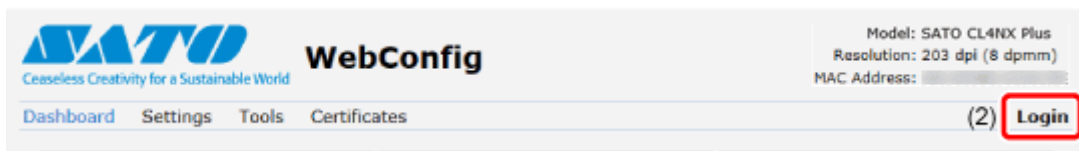

- b. Select [settings] for the user, enter the password, and click [Login].

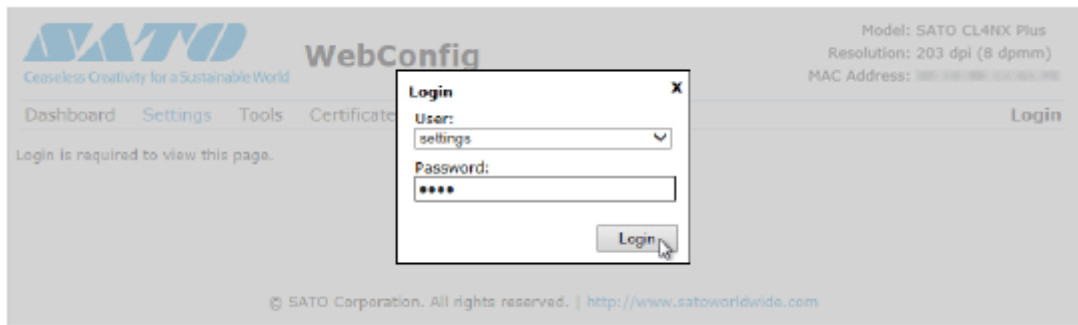

The default user is [settings], and the default password is "0310".

3. Click on the page (3) you want to view.

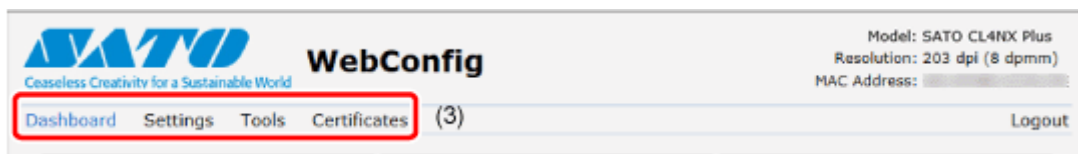

Dashboard

[Dashboard] is the default page for the web configuration page. Each section shows specific information or the current status of the product.



- You can view the [Dashboard] page without logging in.

The screenshot displays the SATO WebConfig dashboard with the following sections:

- Printer Status:** Shows the printer is Offline.
- Printing:** Displays Speed: 6 ips, Darkness Range: A, Darkness: 5, Sensor Type: Gap, Print Mode: Tear-Off, and Backfeed: Before.
- Device:** Lists Model: CL4NX Plus 203dpi, Resolution: 203 dpi (8 dpmm), Serial Number, PCB Serial Number, and Installed Options: Bluetooth, Ext I/O, NFC, WLAN.
- Network:** Shows IPv4 Address and MAC Address.
- System:** Displays Firmware version, Uptime: 18min, Contact, Name, and Location.
- Wi-Fi:** Shows Mode: infra, SSID, BSSID, and Channel: 1 (2412 MHz).
- Wi-Fi Strength:** A gauge showing a signal strength of -39 dBm.

(1) [Printer Status]

Shows the current state (online, offline, error) and current status icons.

(2) [Printing]

Shows the print speed, darkness, sensor, print mode and backfeed setting.

(3) [Device]

Shows the model, current resolution and options that are installed.

(4) [Network]

Shows the current IP address and MAC address of the active interface.

(5) [System]

Shows the current firmware version, uptime, SNMP contact, name and location.

(6) [Wi-Fi]

Shows the current Wi-Fi setting.



- This information is shown only if Wi-Fi is available and active.

(7) [Wi-Fi Strength]

Shows the current Wi-Fi communication strength.



- If the product is P2P GO, the Wi-Fi Strength will not be shown.
-

Settings

The settings equivalent to the product's Settings mode can be performed on the browser.



- Login is required to view the [Settings] page. Click [Login] to log in before opening the [Settings] page.

The default user is [settings], and the default password is "0310".

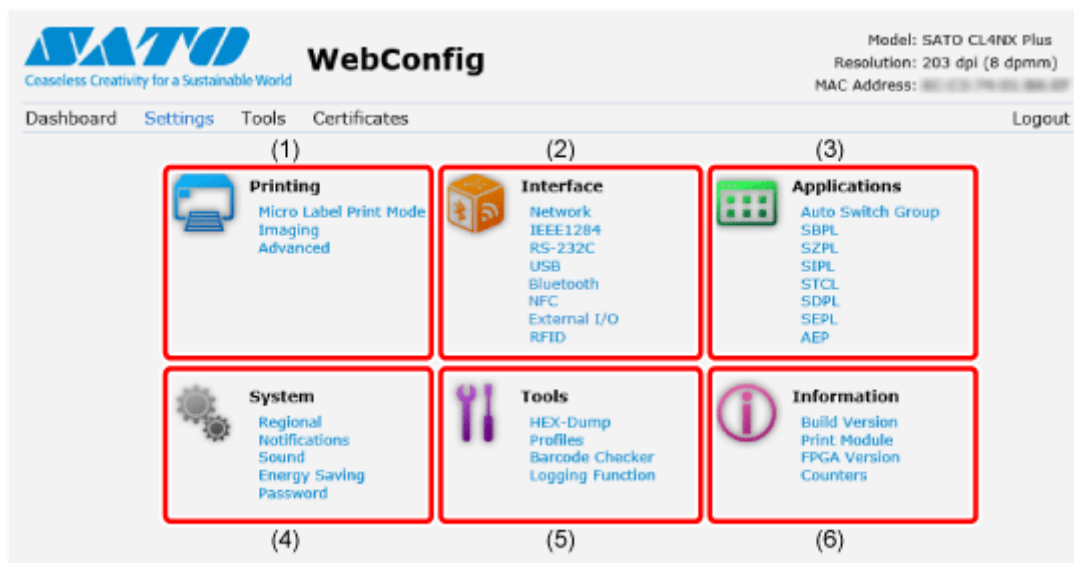

(1) [Printing]

You can do the settings equivalent to the [Printing] menu in the Settings mode.

(2) [Interface]

You can do the settings equivalent to the [Interface] menu in the Settings mode.

(3) [Applications]

You can do the settings equivalent to the [Applications] menu in the Settings mode.

(4) [System]

You can do the settings equivalent to the [System] menu in the Settings mode.

(5) [Tools]

You can do the settings equivalent to the [Tools] menu in the Settings mode.

(6) [Information]

You can do the settings equivalent to the [Information] menu in the Settings mode.

The screen below is the example of [Printing] page.

SATO WebConfig
Ceaseless Creativity for a Sustainable World

Model: SATO CL4NX Plus
Resolution: 203 dpi (8 dpmm)
MAC Address: 88:13:74:00:00:00

Dashboard Settings Tools Certificates Logout

Printing

Label Length: 20000 1 <-> 20000 dot
Label Width: 832 1 <-> 832 dot
Auto Measure:
Printing Mode: Use Ribbon
Ribbon Near End:
Speed: 6
Sensor Type: Gap

Micro Label Print Mode

Auto-mode:
Print Mode: Tear-Off
Backfeed: Before
Darkness Range: A
Darkness: 5

Imaging

Advanced



- If you have changed the RFID antenna position in the [Interface] > [RFID] > [Antenna Position] menu on the Web Configuration Page, restart the product. Just changing the setting values does not affect the position of the antenna.
- If a message prompting you to restart the product appears at the top of the page, click [Reboot printer] to reboot the product to apply the settings.

SATO WebConfig
Ceaseless Creativity for a Sustainable World

Model: SATO CL4NX Plus
Resolution: 203 dpi (8 dpmm)
MAC Address: 88:13:74:00:00:00

Dashboard Settings Tools Certificates Logout

Restart to apply changes.
Reboot printer

Tools

Various settings and operations can be performed in this page: installing certificates for authentication, checking the log, and test printing.



- Login is required to view the [Tools] page. Click [Login] to log in before opening the [Tools] page.

The default user is [settings], and the default password is "0310".

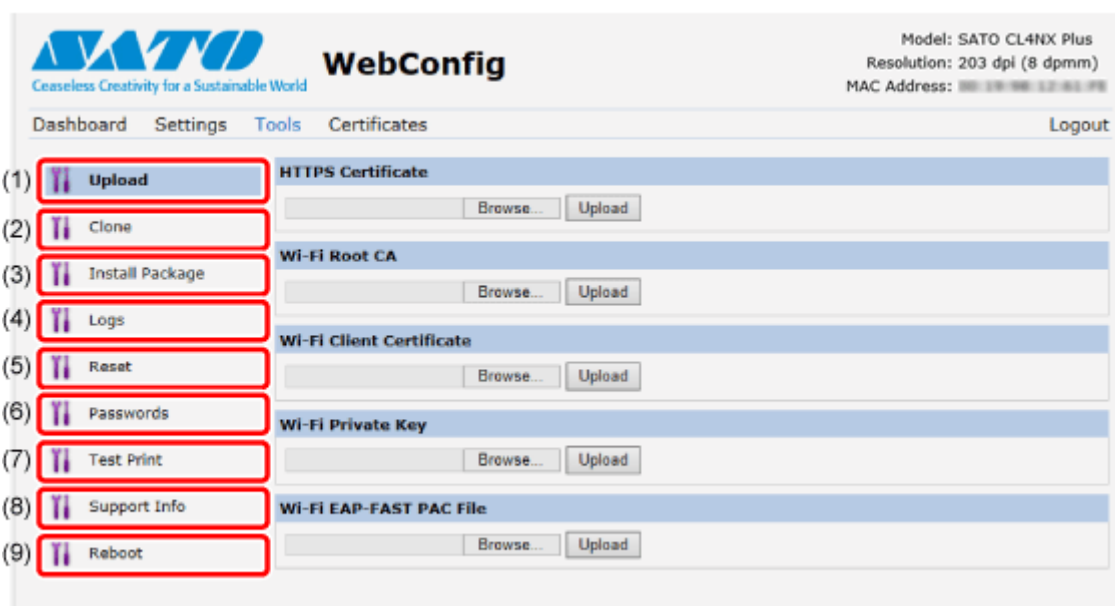

(1) [Upload]

You can do the setting equivalent to [Tools] > [Certificates] in the Settings mode.

Install certificates used for Wi-Fi authentication and for HTTPS.

Click [Browse] of the certificate you want to install.

Select the certificate file from the list and click [Upload], and the authentication file will be installed.

(2) [Clone]

You can do the setting equivalent to [Tools] > [Clone] in the Settings mode. Copy the current product settings and the data that is installed.

(3) [Install Package]

Contact your SATO reseller or technical support for more information of the package file.

(4) [Logs]

List all log files in the log directory. Users can click to download the file.

(5) [Reset]

You can do the setting equivalent to [Tools] > [Reset] in the Settings mode. Initialize the setting values and data saved on the product.

(6) [Passwords]

You can do the setting equivalent to [System] > [Password] > [Change Password] in the Settings mode. Change the each password of the product.

(7) [Test Print]

You can do the setting equivalent to [Tools] > [Test Print] in the Settings mode. Perform a test print.

(8) [Support Info]

You can do the setting equivalent to [Tools] > [Support Info] in the Settings mode.

You can also get a screenshot of the current product display and an image of the last printout.

(9) [Reboot]

Reboot the product.

Certificates

Shows the root certificate authority and client certificates installed on the product.

Model: SATO CL4NX Plus
Resolution: 203 dpi (8 dppm)
MAC Address: 88:09:00:00:00:00

Dashboard Settings Tools **Certificates** Login

Installed Certificates

HTTPS (Pre-installed)

Certificate:
 Data:
 Version: 1 (0x0)
 Serial Number:
 cc:66:4b:54:a9:35:de:6a
 Signature Algorithm: sha1WithRSAEncryption
 Issuer: C=SE, ST=Vastergotland, L=Gothenburg, O=SATO Techno Lab Europe AB
 Validity
 Not Before: Jun 17 08:49:30 2014 GMT
 Not After : Jun 17 08:49:30 2024 GMT
 Subject: C=SE, ST=Vastergotland, L=Gothenburg, O=SATO Techno Lab Europe AB
 Subject Public Key Info:
 Public Key Algorithm: rsaEncryption
 Public-Key: (2048 bit)
 Modulus:
 00:ab:a9:b6:c4:35:3b:08:90:c0:b1:08:6b:db:5f:
 bc:a2:02:09:3e:3d:d4:55:23:0a:4d:ad:35:16:75:
 d1:02:1c:5c:1c:26:0e:5c:bf:1b:69:f9:69:b2:00:
 77:71:e6:a4:f9:45:11:55:03:93:e5:46:c9:5d:e9:
 6e:2b:d6:7c:e4:7f:60:44:0c:38:ad:0c:f7:9c:7c:
 d5:a1:0d:f4:38:6c:32:2c:98:40:7a:b2:97:c8:72:
 e0:fe:7c:2a:b3:cb:a6:da:1b:f2:af:63:d6:e9:cb:
 c6:d3:aa:7b:01:5e:a9:75:98:06:10:c9:a0:13:32:
 b2:30:7d:ac:84:00:33:f7:29:4c:48:4b:8c:f1:8d:



- The client certificate that is a PFX (PKCS #12) file will not be shown.

Various Ways to Output

Outputting with General-purpose Software

Labels can be easily output by using software, such as the NiceLabel series.

- NiceLabel series

This software has multiple functions and is easy to operate so you can create and print labels with richly versatile layouts.



- For details of the products, contact your SATO sales representative.
-

Outputting and Controlling with Dedicated Command

A variety of labels and tags can be printed from simple formats to complex formats by sending an SBPL (SATO Barcode Printer Language) command to the product.

In addition, you can print characters, barcodes, and graphics in various styles by combining multiple SBPL commands. There are many functions for modifying the printed items, such as enlarging fonts, specifying a print direction, ruled line, and black and white reverse printing.

For programming references, contact your SATO sales representative or technical support.

Controlling the Product with External Signal

By using the external signal (EXT) interface, you can connect the product to an external device and print. With the control signal, you can control print operations; such as monitoring the condition of the product, starting printing, and reprinting.

Adjusting the Product

Printable Area

The printable area of the product is as follows:

CL4NX Plus

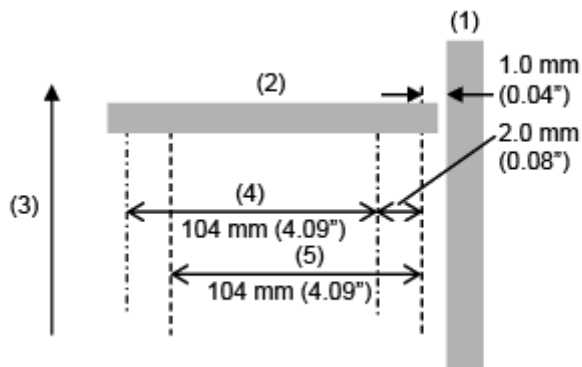

- (1) Frame
- (2) Print head
- (3) Media feed direction
- (4) Printable area (Standard)
- (5) Printable area (Left-justify)

CL6NX Plus

- 203 dpi

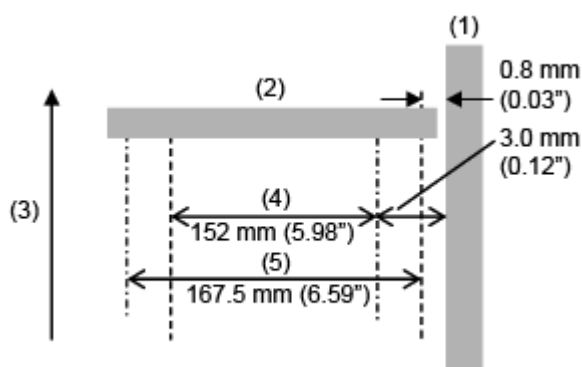

- (1) Frame
- (2) Print head
- (3) Media feed direction
- (4) Printable area (Standard)
- (5) Printable area (Left-justify)

- 305 dpi

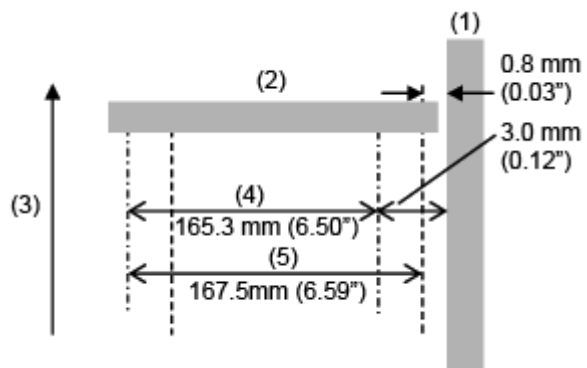

- (1) Frame
- (2) Print head
- (3) Media feed direction
- (4) Printable area (Standard)
- (5) Printable area (Left-justify)

Media Sensor Positions and Media Stop Positions

The media stop positions with the media sensor and various operation modes are as follows:

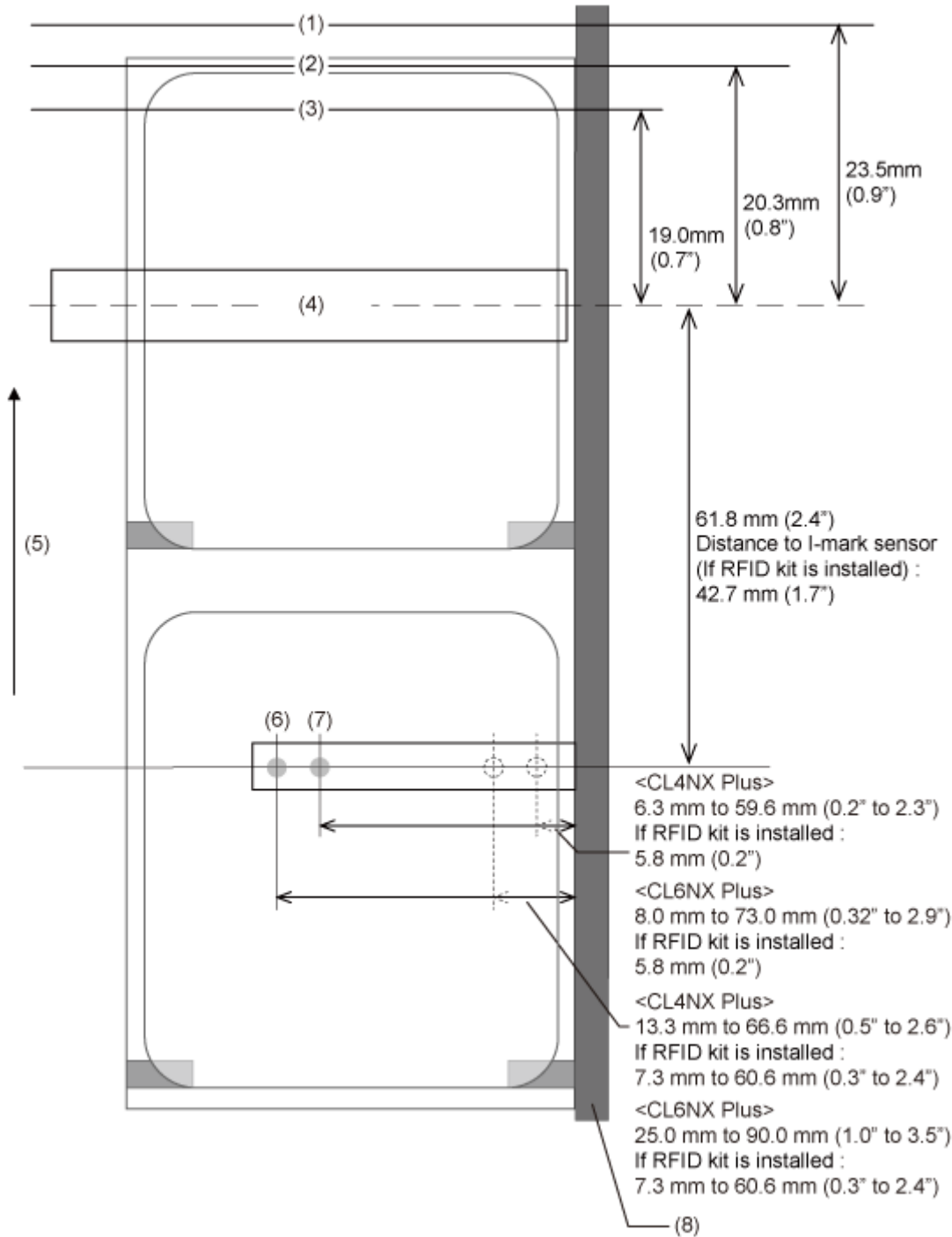

- (1) Media stop position in dispenser mode
- (2) Media stop position in cutter mode
- (3) Media stop position in tear-off mode
- (4) Print head
- (5) Media feed direction
- (6) Gap sensor

(7) I-mark sensor

(8) Frame



- If you use the notched media and when detecting the media position on the notched area, the dedicated parts are needed to be installed. By installing the dedicated parts, the moving range of the media sensor changes to inner side than the standard specification. If you adjust the media sensor position to the inner side, a false detection of the paper end may occur. In this case, change the setting of [Paper End] to [Using Gap] (Gap sensor).

For details, contact your SATO sales representative or reseller.

Flow of Printing Operations

Printing Operations

Printing operations vary depending on the combination of the following settings.

- Print Mode
- Enabled/disabled media sensor
- With/without pulse input (from external signal (EXT) interface)
- Enabled/disabled head check

Operations in Continuous Mode

Continuous Mode Without Pulse Input (Head Check Disabled)

Operation

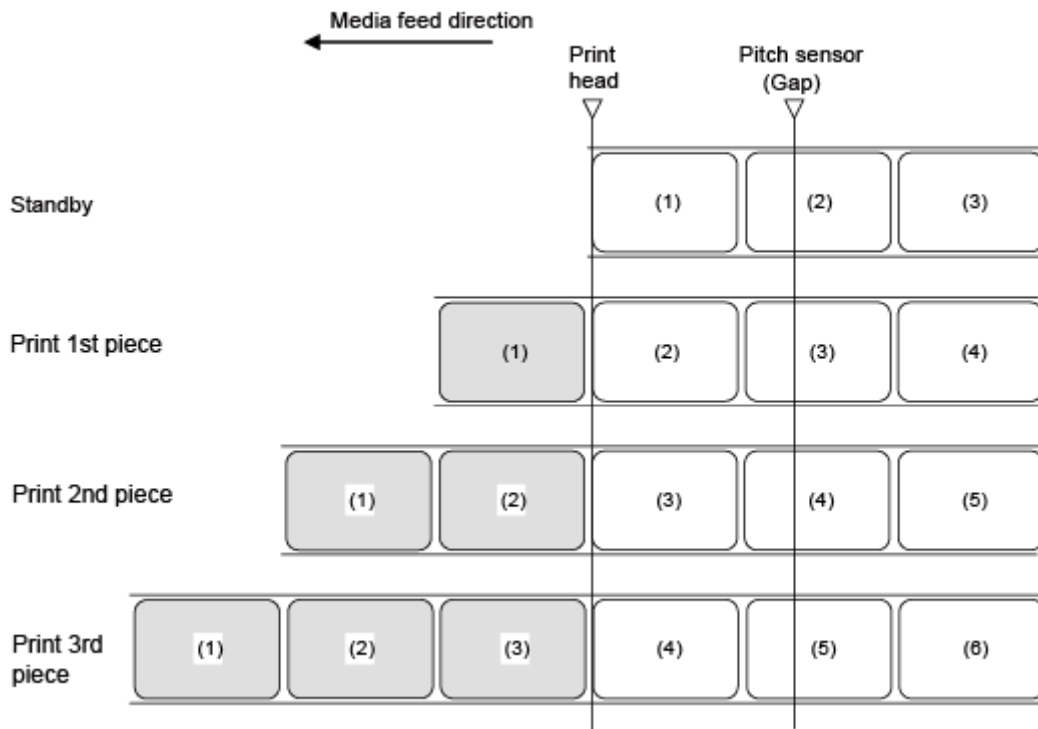

- The figure above shows the reference position when the Gap sensor is used.

Timing Chart

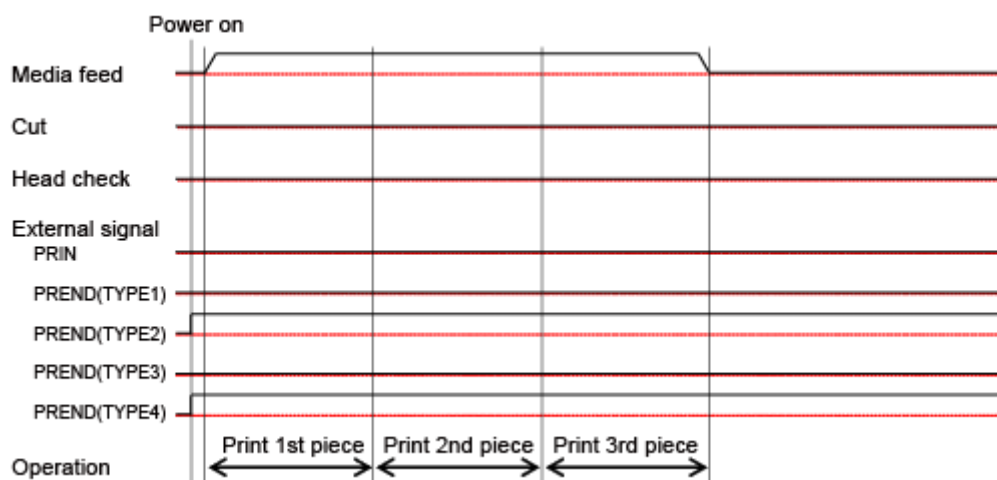

Continuous Mode Without Pulse Input (Head Check Enabled)

Operation

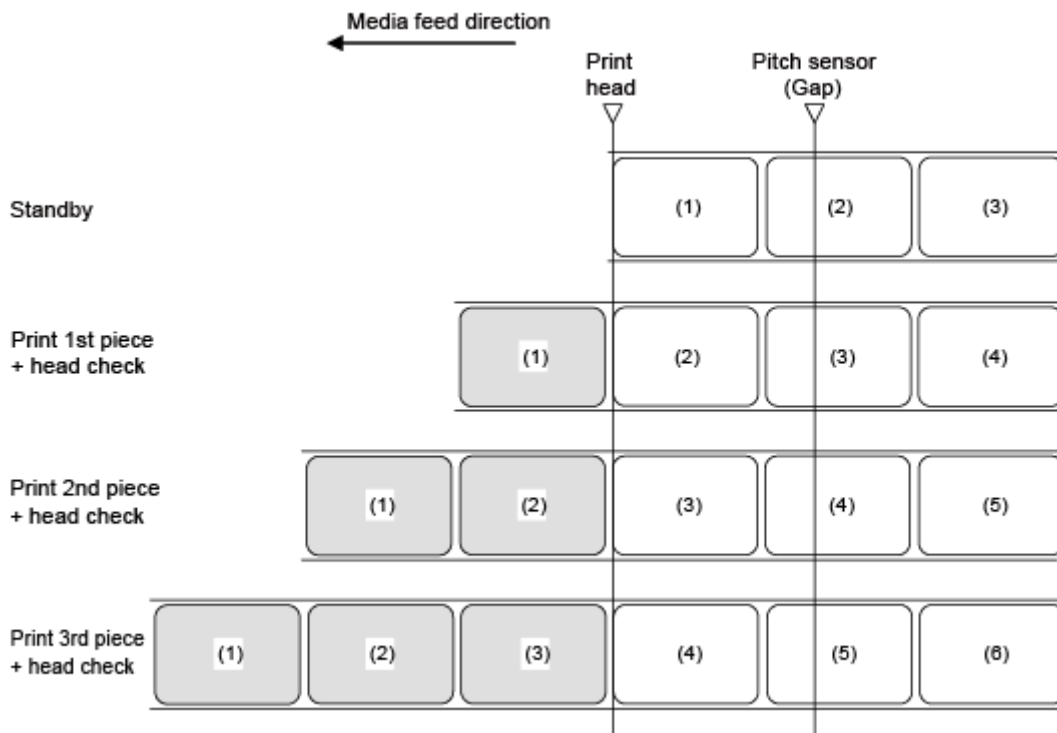

- The figure above shows the reference position when the Gap sensor is used.

Timing Chart

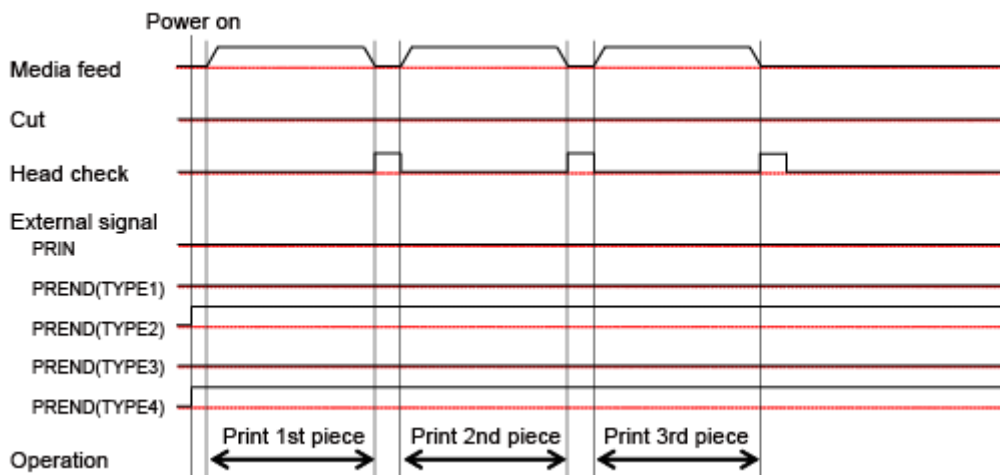

Continuous Mode with Pulse Input (Head Check Disabled)

Operation

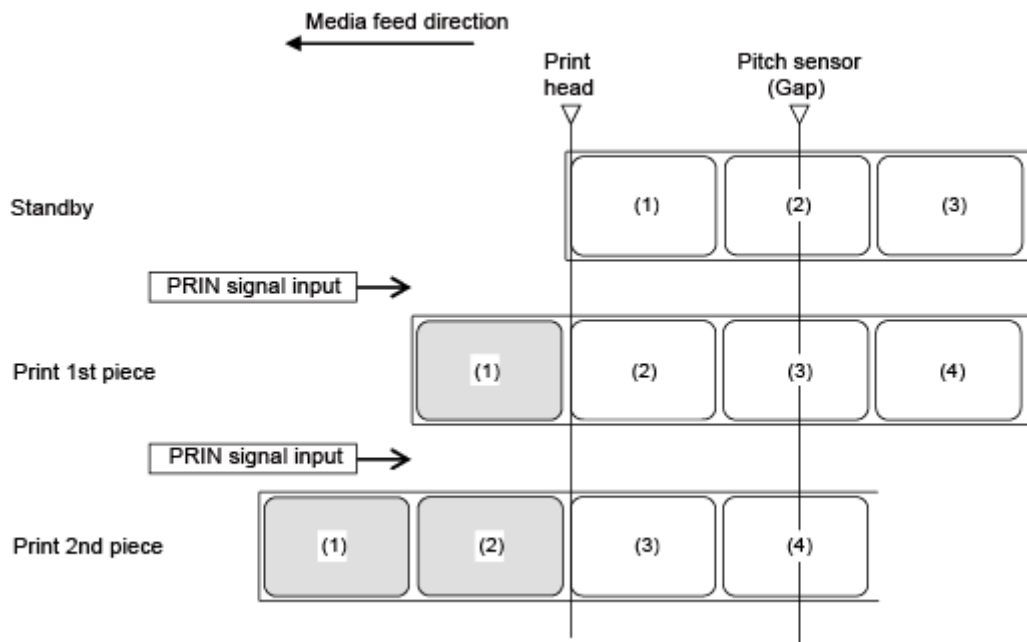

- The figure above shows the reference position when the Gap sensor is used.

Timing Chart

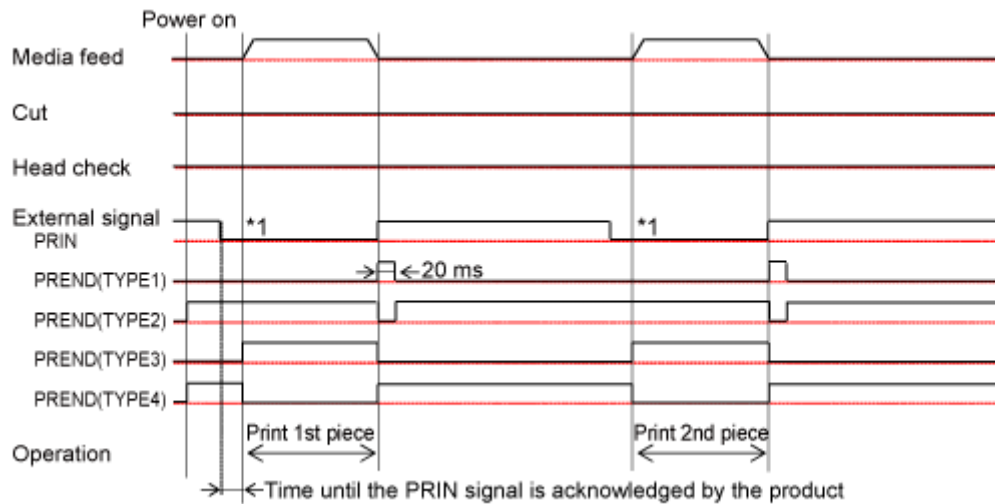

- *1 Keep the PRIN signal until the PREND signal is outputted.

Continuous Mode with Pulse Input (Head Check Enabled)

Operation

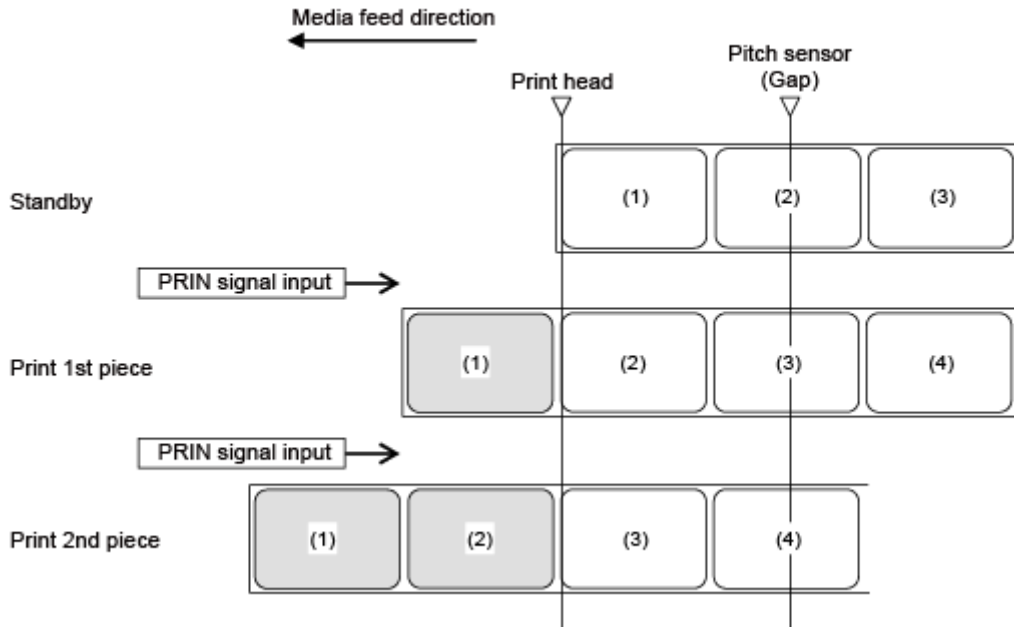

- The figure above shows the reference position when the Gap sensor is used.

Timing Chart

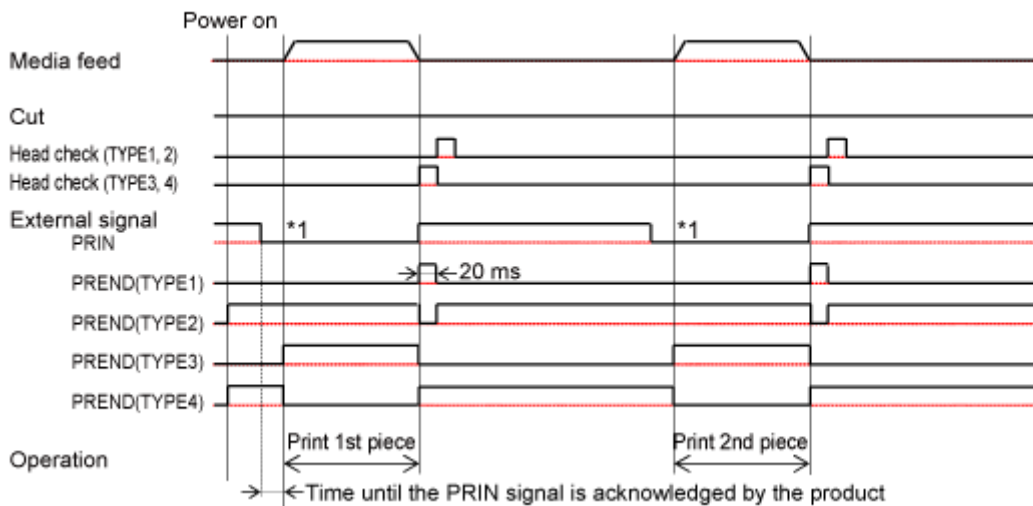

- *1 Keep the PRIN signal until the PREND signal is outputted.

Operations in Tear-Off Mode

Tear-Off Mode Without Pulse Input (Head Check Disabled)

Operation

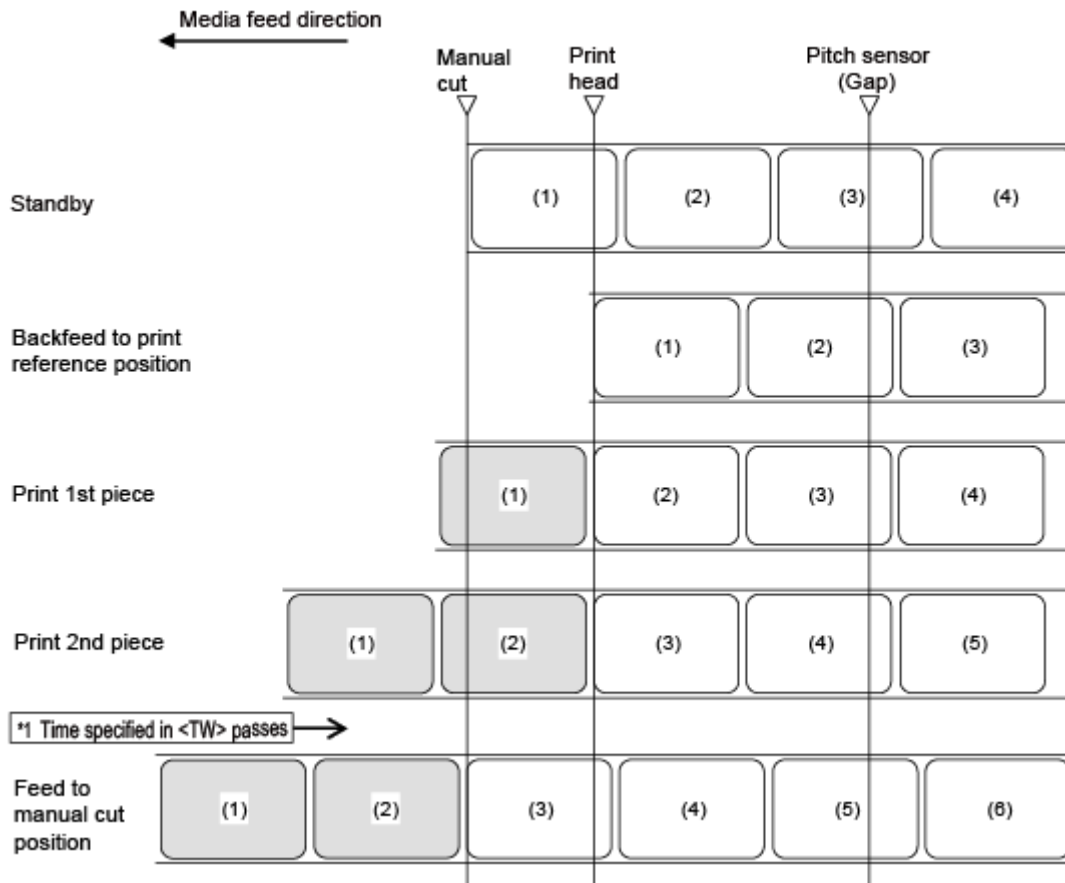

*1 After printing, if the period specified in Option Waiting Time <TW> (initial value: 0 ms) has passed and if there is no print data remaining, the product will feed the media to the position for manual cutting.



- The figure above shows the reference position when the Gap sensor is used.

Timing Chart (When <TW> is 0)

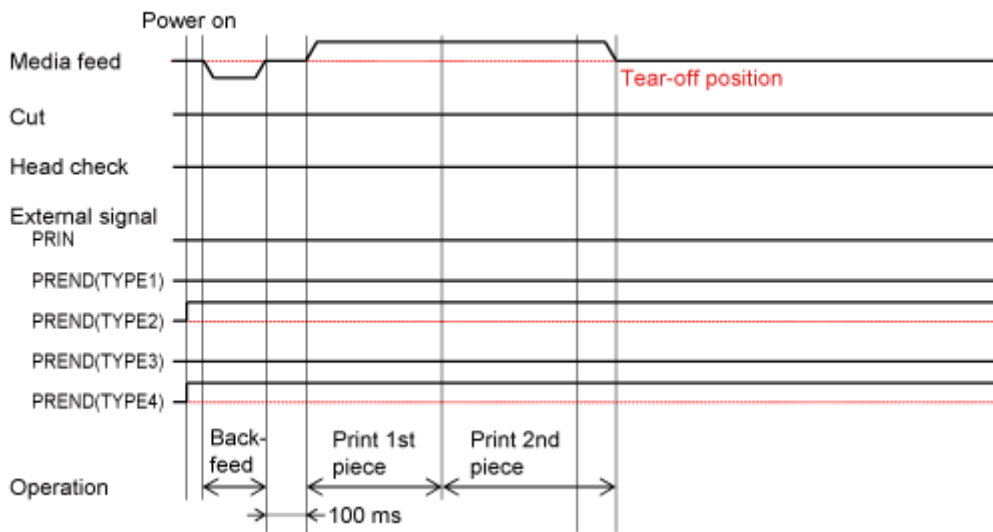

Timing Chart (When <TW> is 500)

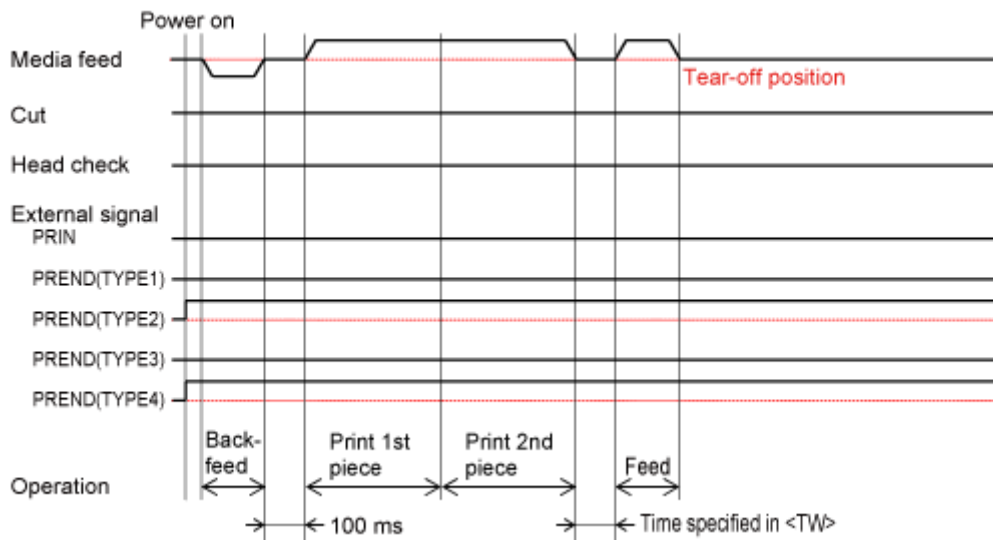

Tear-Off Mode Without Pulse Input (Head Check Enabled)

Operation

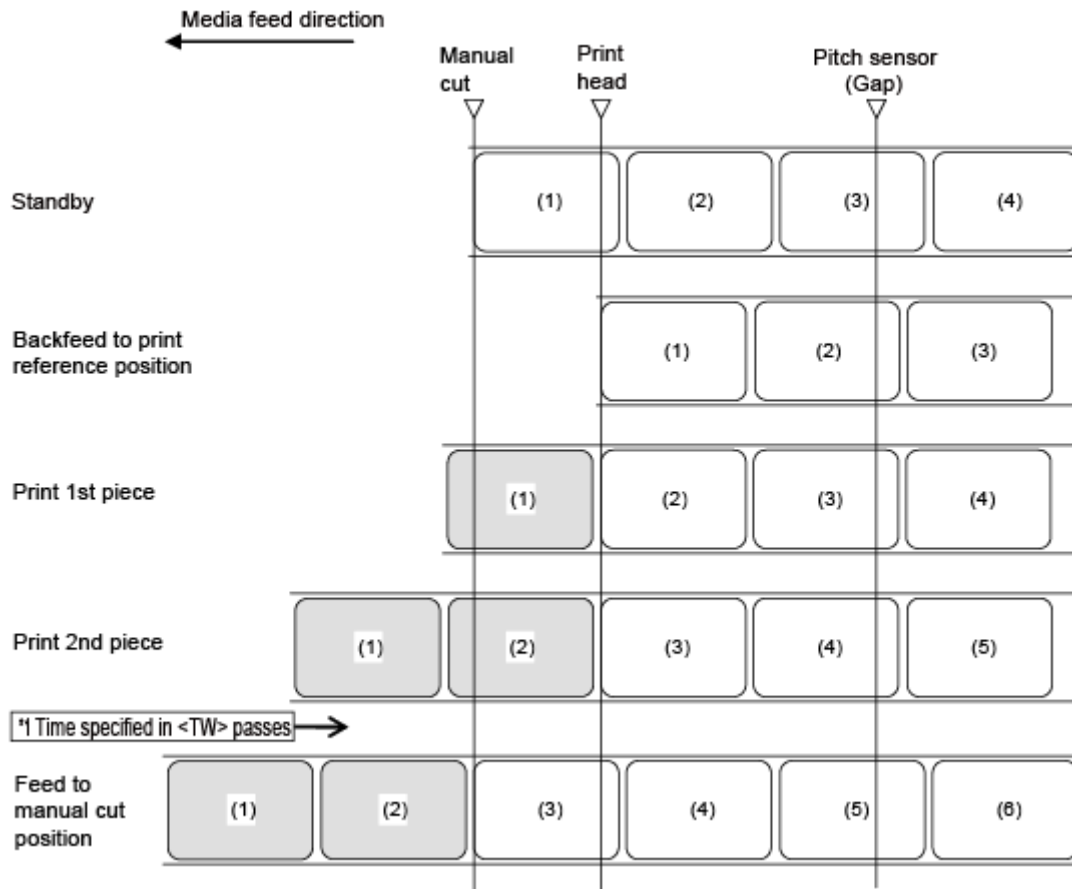

*1 After printing, if the period specified in Option Waiting Time <TW> (initial value: 0 ms) has passed and if there is no print data remaining, the product will feed the media to the position for manual cutting.



- The figure above shows the reference position when the Gap sensor is used.

Timing Chart (When <TW> is 0)

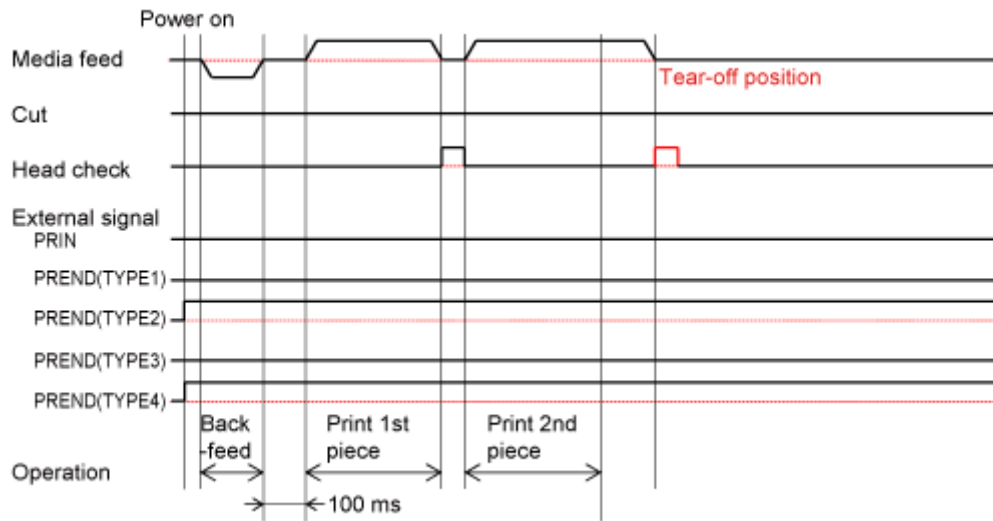

Timing Chart (When <TW> is 500)

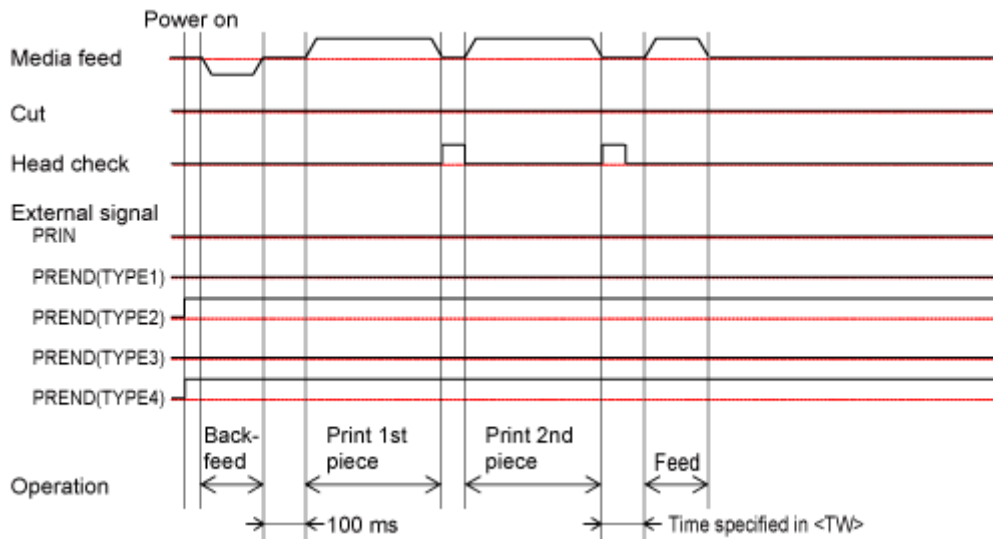

Tear-Off Mode with Pulse Input (Head Check Disabled)

Operation

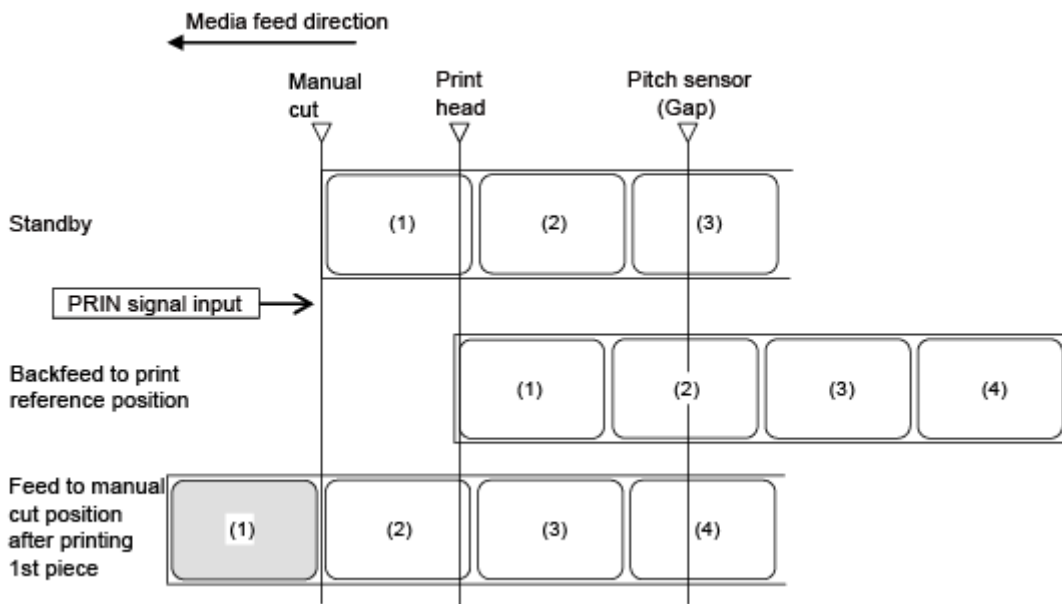

- The figure above shows the reference position when the Gap sensor is used.

Timing Chart

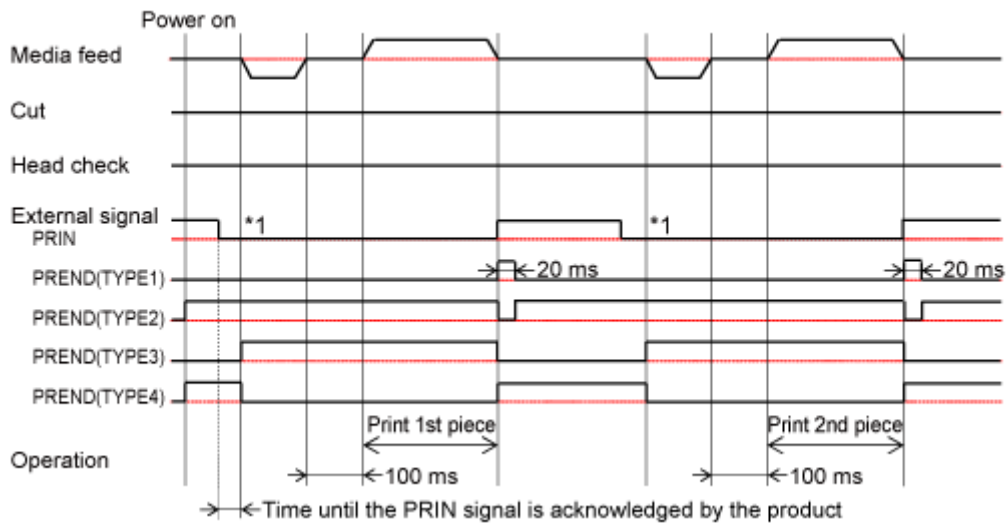

- *1 Keep the PRIN signal until the PREND signal is outputted.

Tear-Off Mode with Pulse Input (Head Check Enabled)

Operation

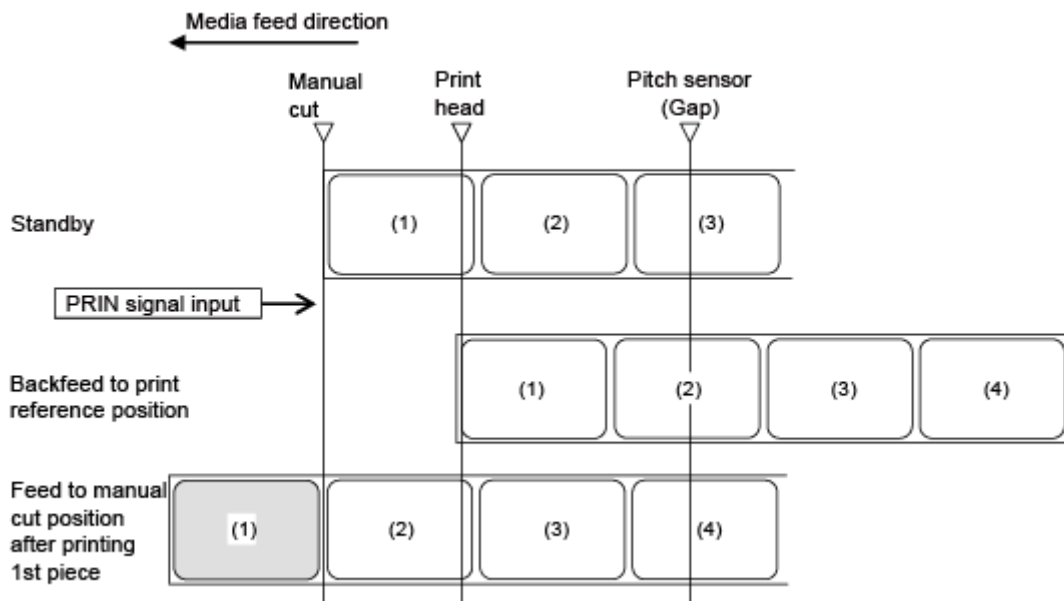

- The figure above shows the reference position when the Gap sensor is used.

Timing Chart

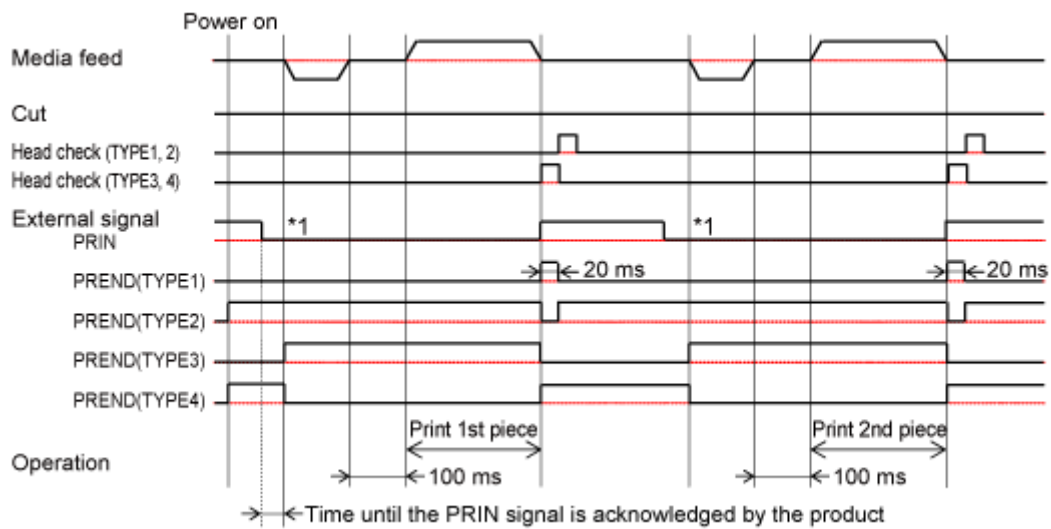

*1 Keep the PRIN signal until the PREND signal is outputted.

Operations in Cutter Mode

Cutter Mode, No Backfeed, and Without Pulse Input (Head Check Disabled)

Operation

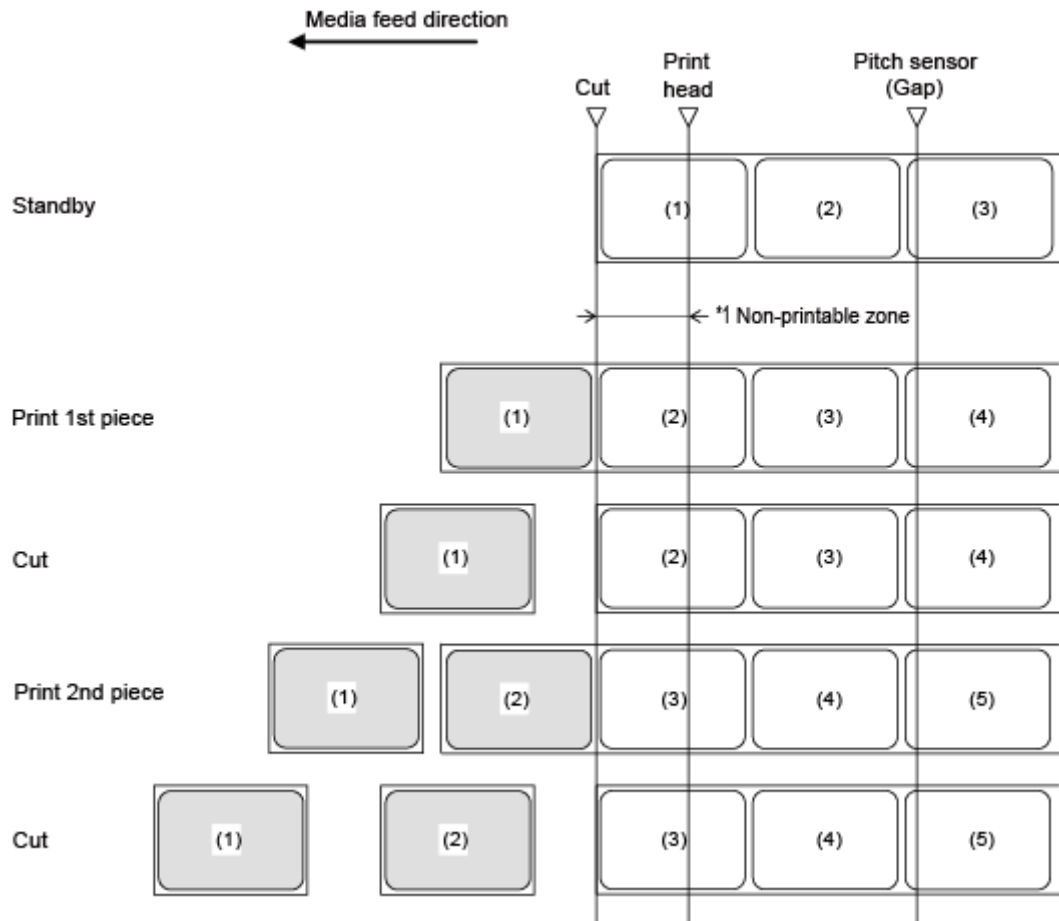

*1 Because backfeeding is not done, the media in the head area becomes non-printable.



- The figure above shows the reference position when the Gap sensor is used.

Timing Chart

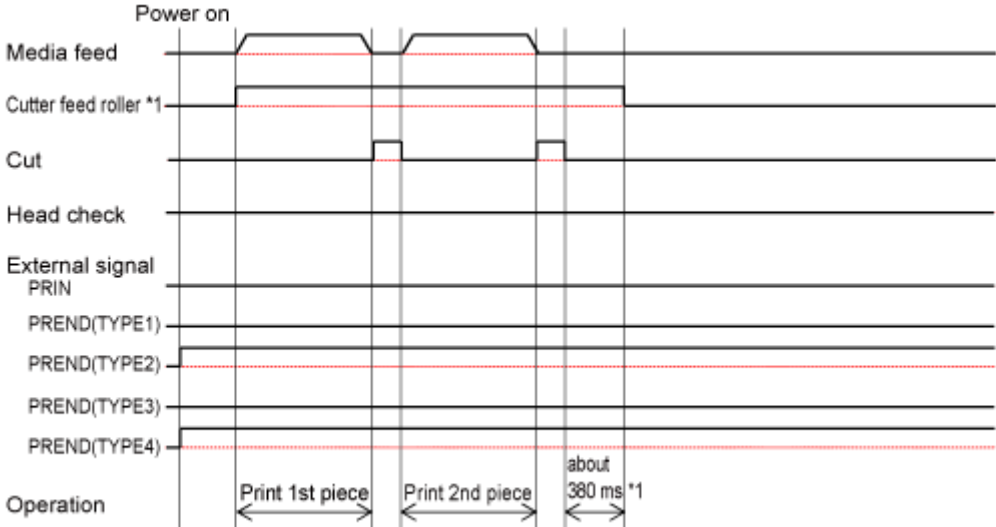

*1 This is applied when the rotary cutter unit is installed.

Cutter Mode, No Backfeed, and Without Pulse Input (Head Check Enabled)

Operation

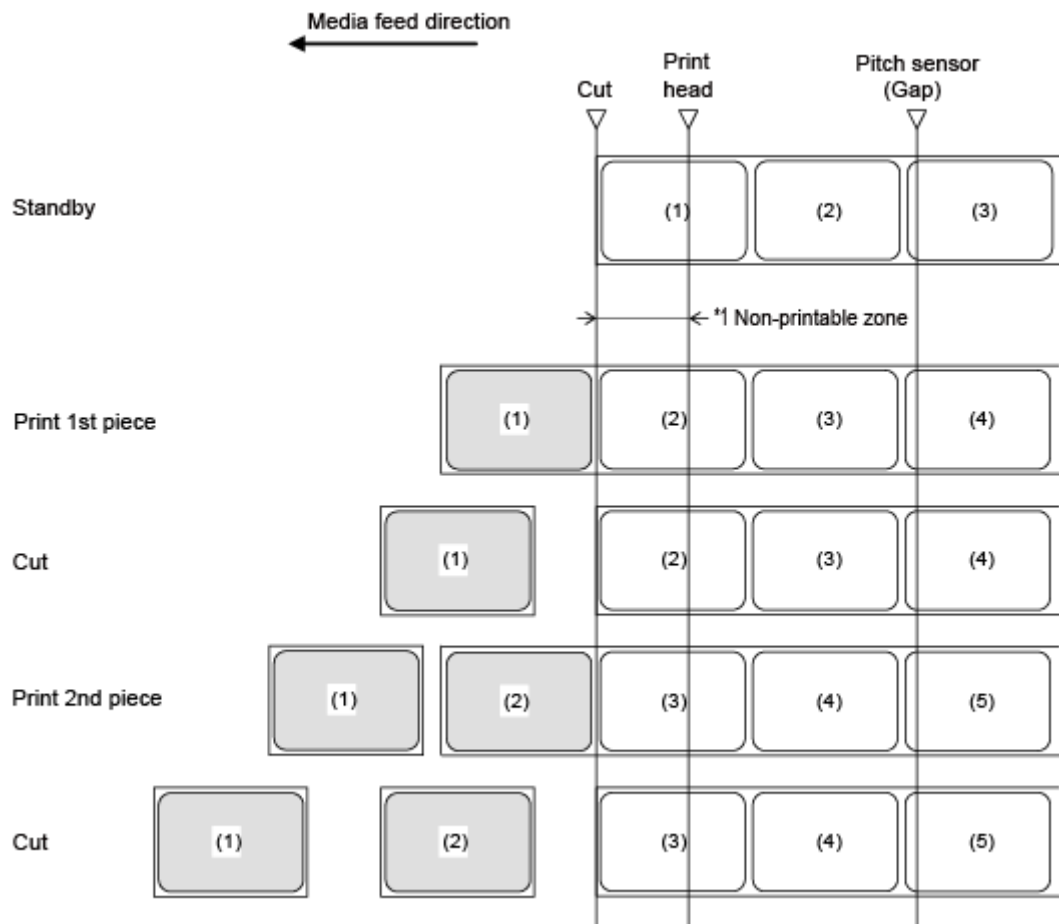

*1 Because backfeeding is not done, the media in the head area becomes non-printable.



- The figure above shows the reference position when the Gap sensor is used.

Timing Chart

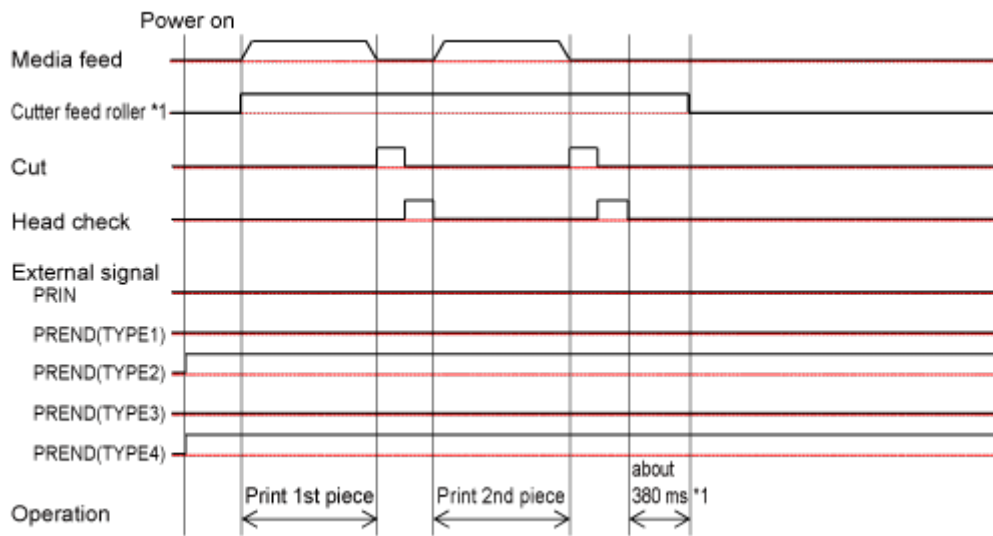

*1 This is applied when the rotary cutter unit is installed.

Cutter Mode, Backfeed After Printing, and Without Pulse Input (Head Check Disabled)

Operation

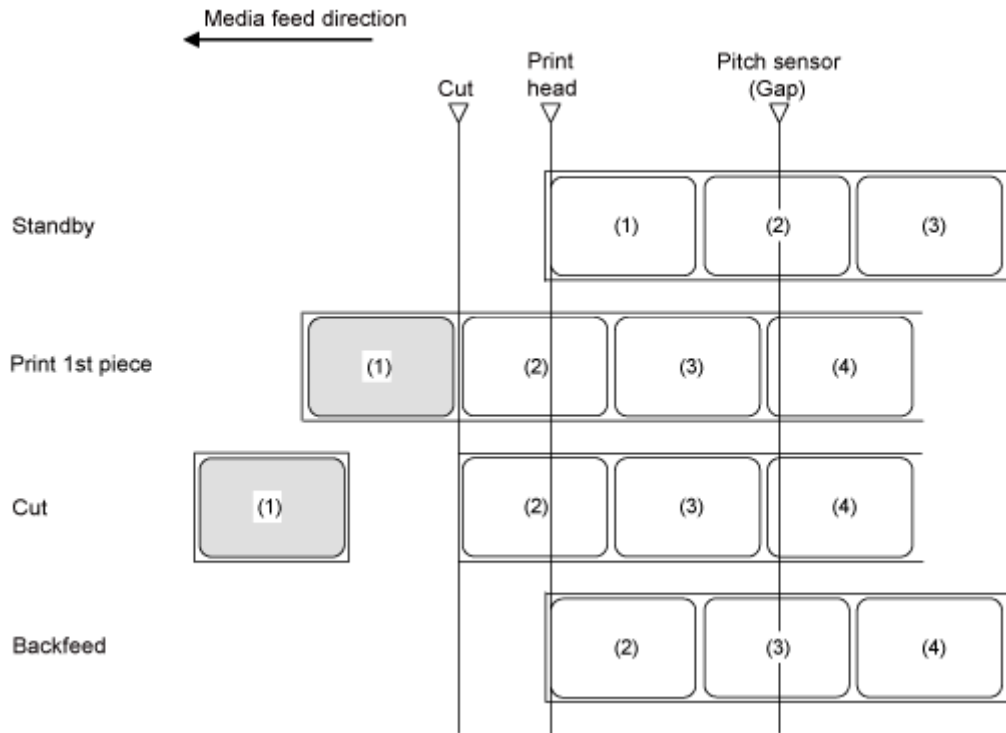

- The figure above shows the reference position when the Gap sensor is used.

Timing Chart

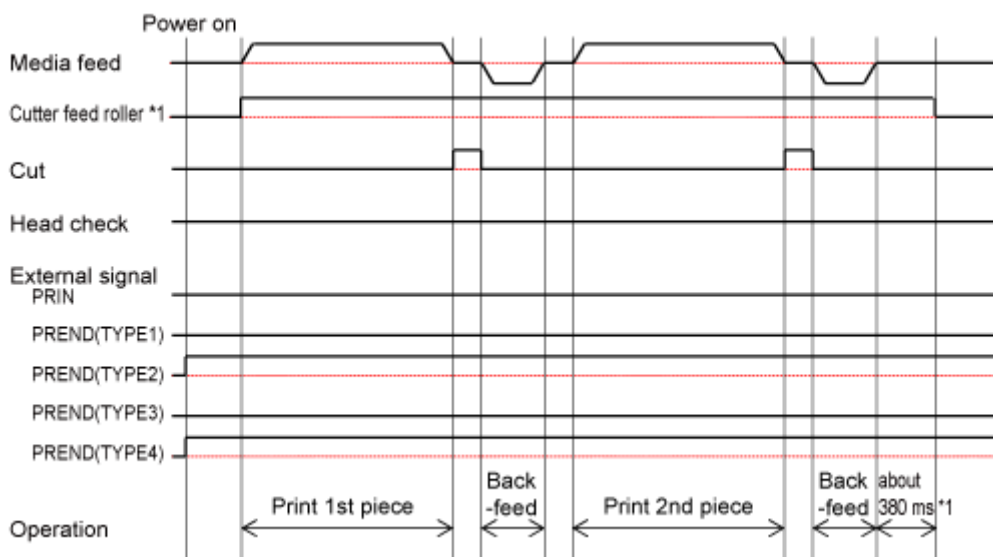

*1 This is applied when the rotary cutter unit is installed.

Cutter Mode, Backfeed After Printing, and Without Pulse Input (Head Check Enabled)

Operation

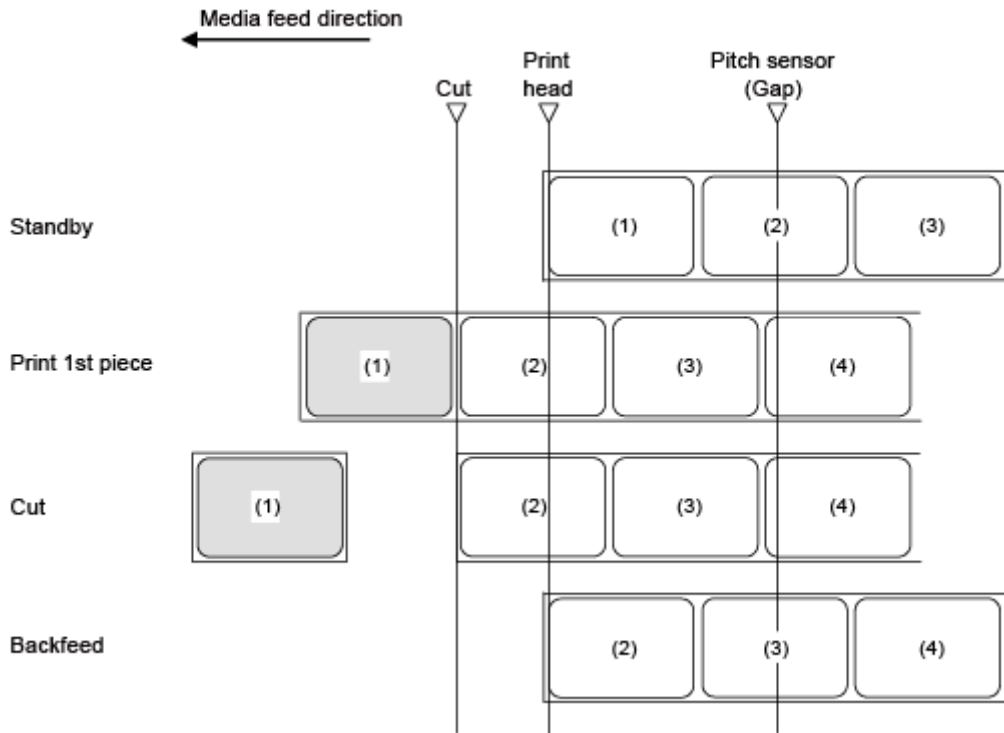

• The figure above shows the reference position when the Gap sensor is used.

Timing Chart

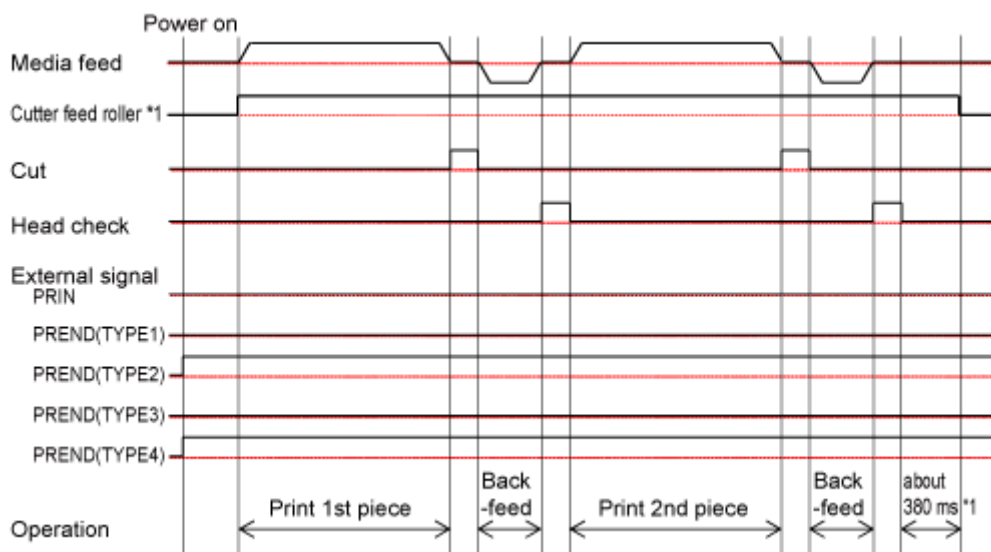

*1 This is applied when the rotary cutter unit is installed.

Cutter Mode, Backfeed Before Printing, and Without Pulse Input (Head Check Disabled)

Operation

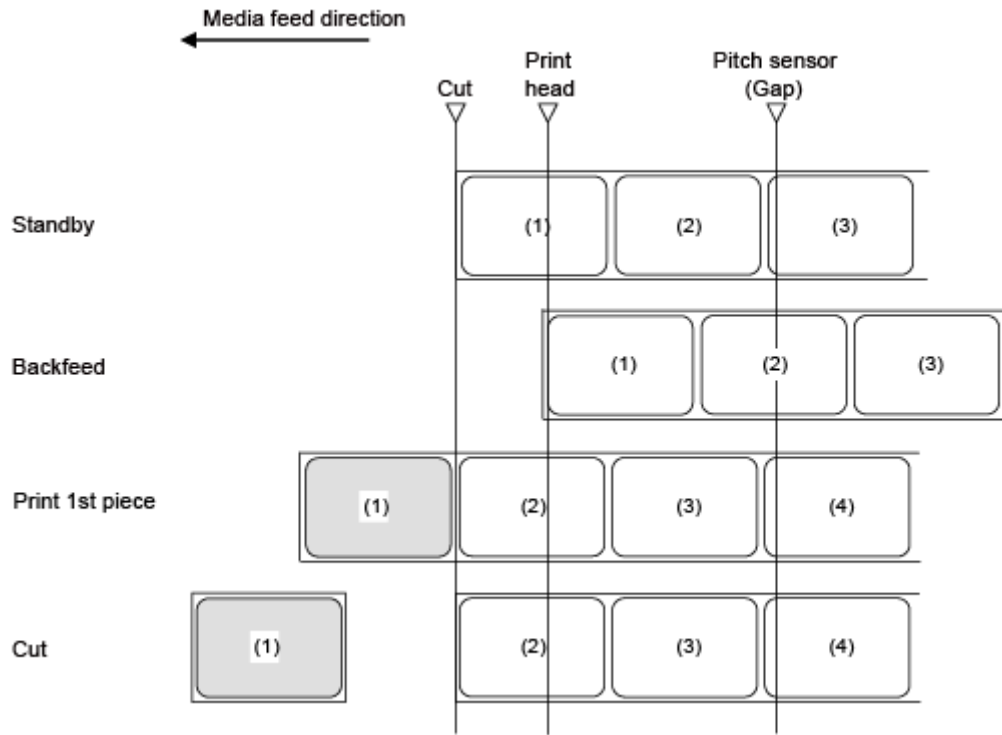

- The figure above shows the reference position when the Gap sensor is used.

Timing Chart

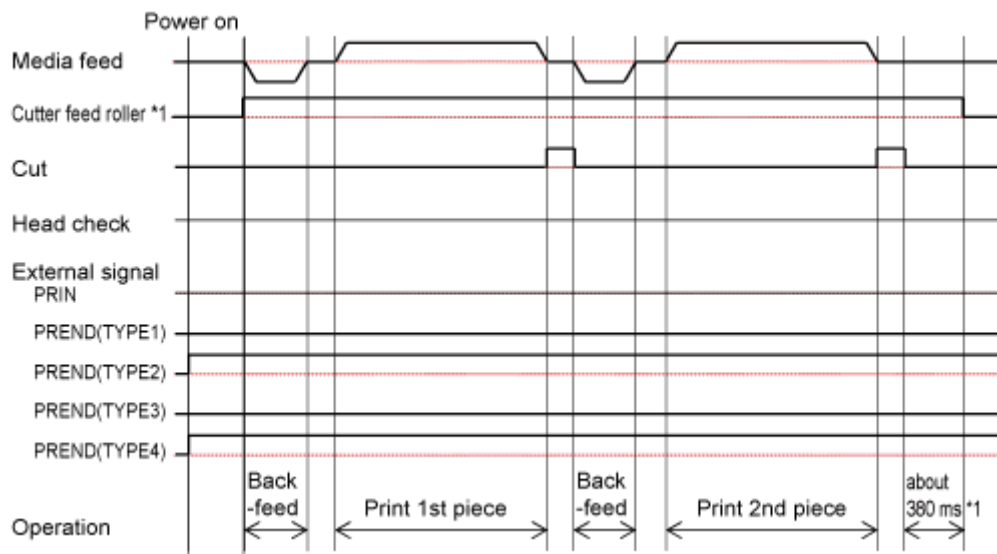

*1 This is applied when the rotary cutter unit is installed.

Cutter Mode, Backfeed Before Printing, and Without Pulse Input (Head Check Enabled)

Operation

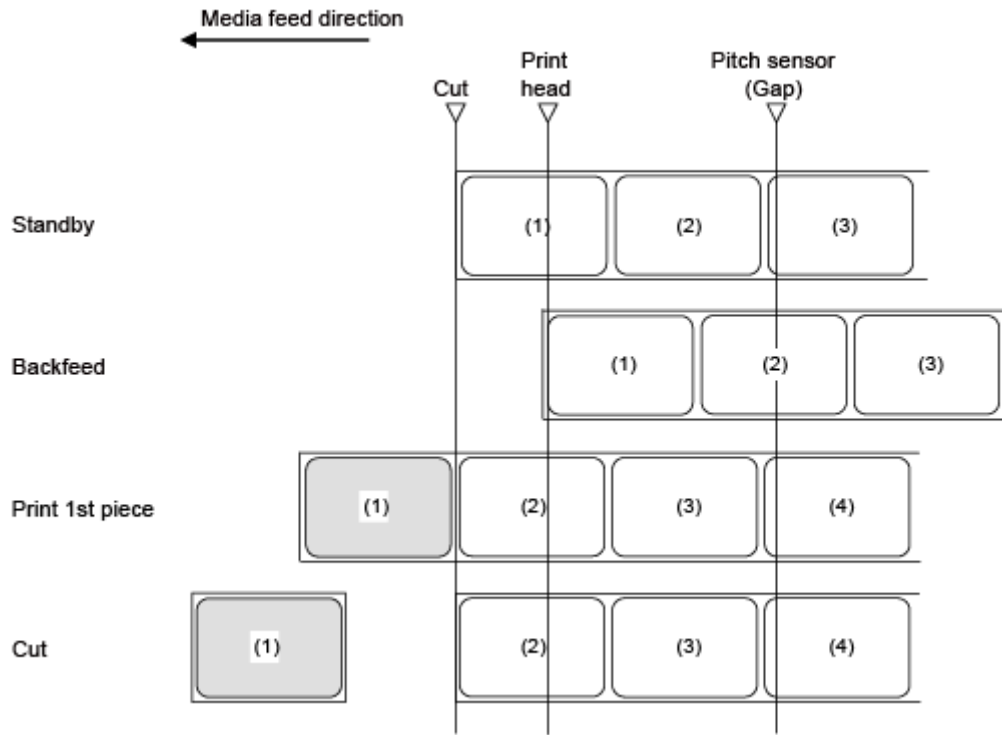

- The figure above shows the reference position when the Gap sensor is used.

Timing Chart

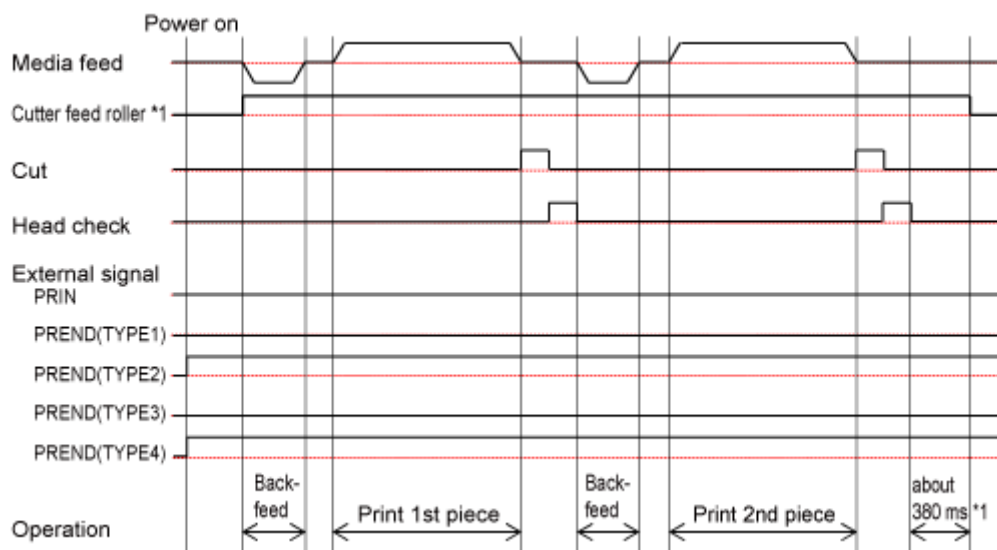

*1 This is applied when the rotary cutter unit is installed.

Cut & Print Mode Without Pulse Input (Head Check Disabled)

Operation

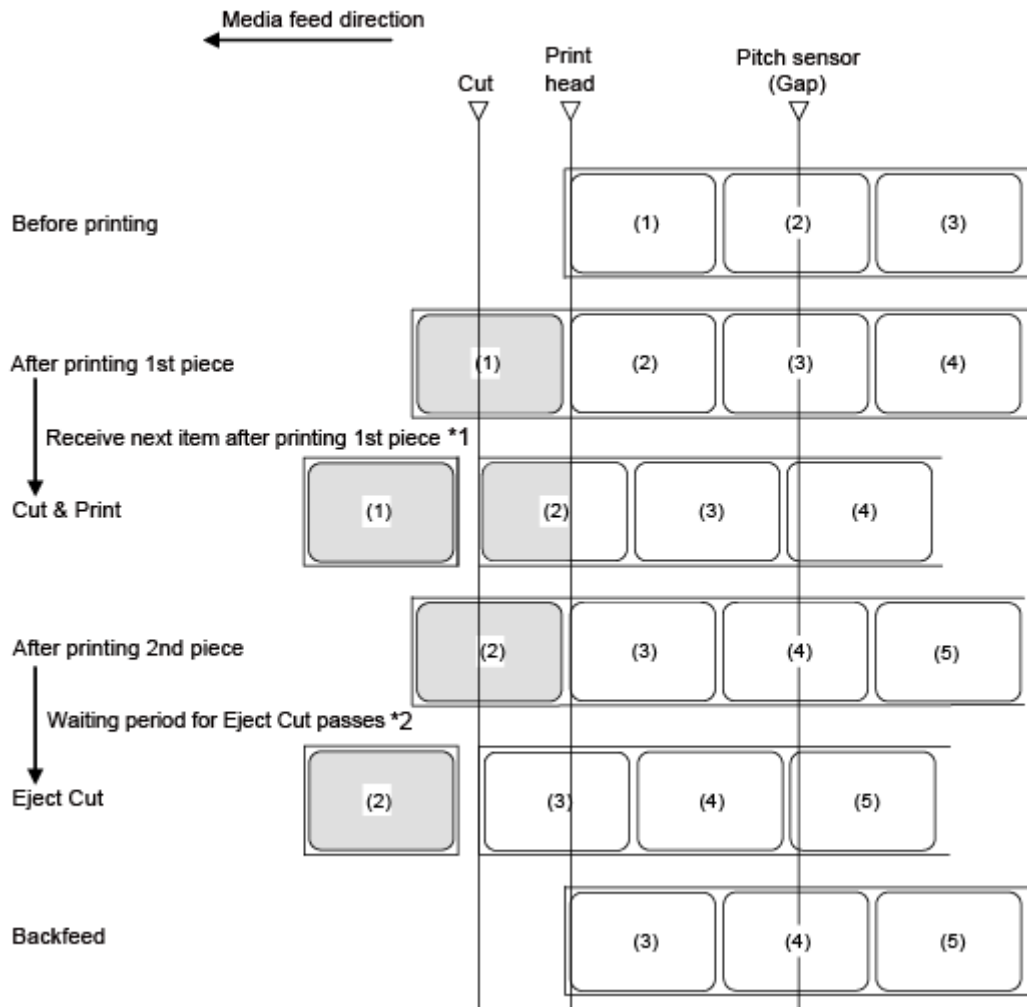

*1 After printing, if the next data is received, printing will be done and the media will be cut on the cut position.

*2 After printing, if the next data is not received and the waiting period for Eject Cut has passed, Eject Cut will be performed.



• The figure above shows the reference position when the Gap sensor is used.

Timing Chart

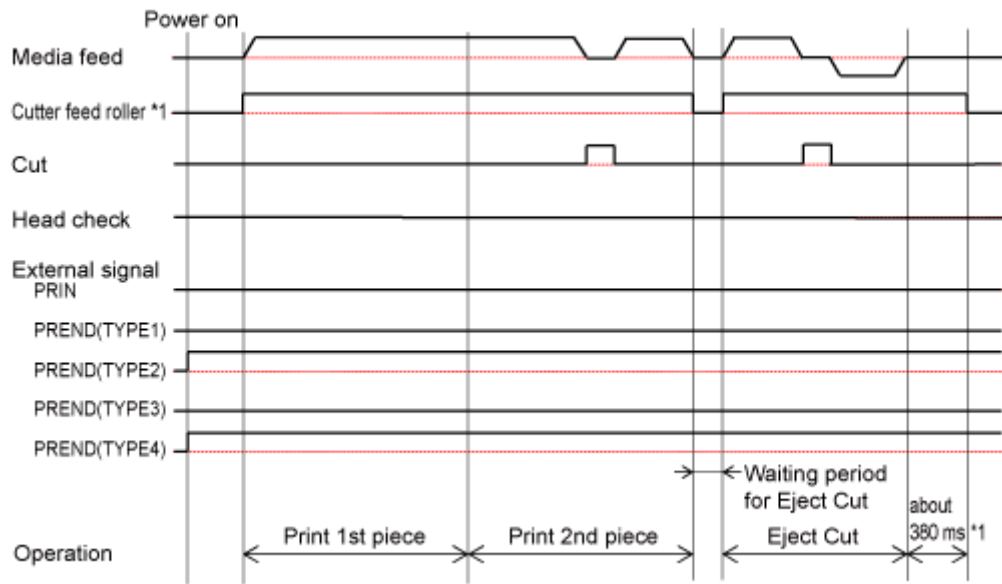

*1 This is applied when the rotary cutter unit is installed.

Cut & Print Mode Without Pulse Input (Head Check Enabled)

Operation

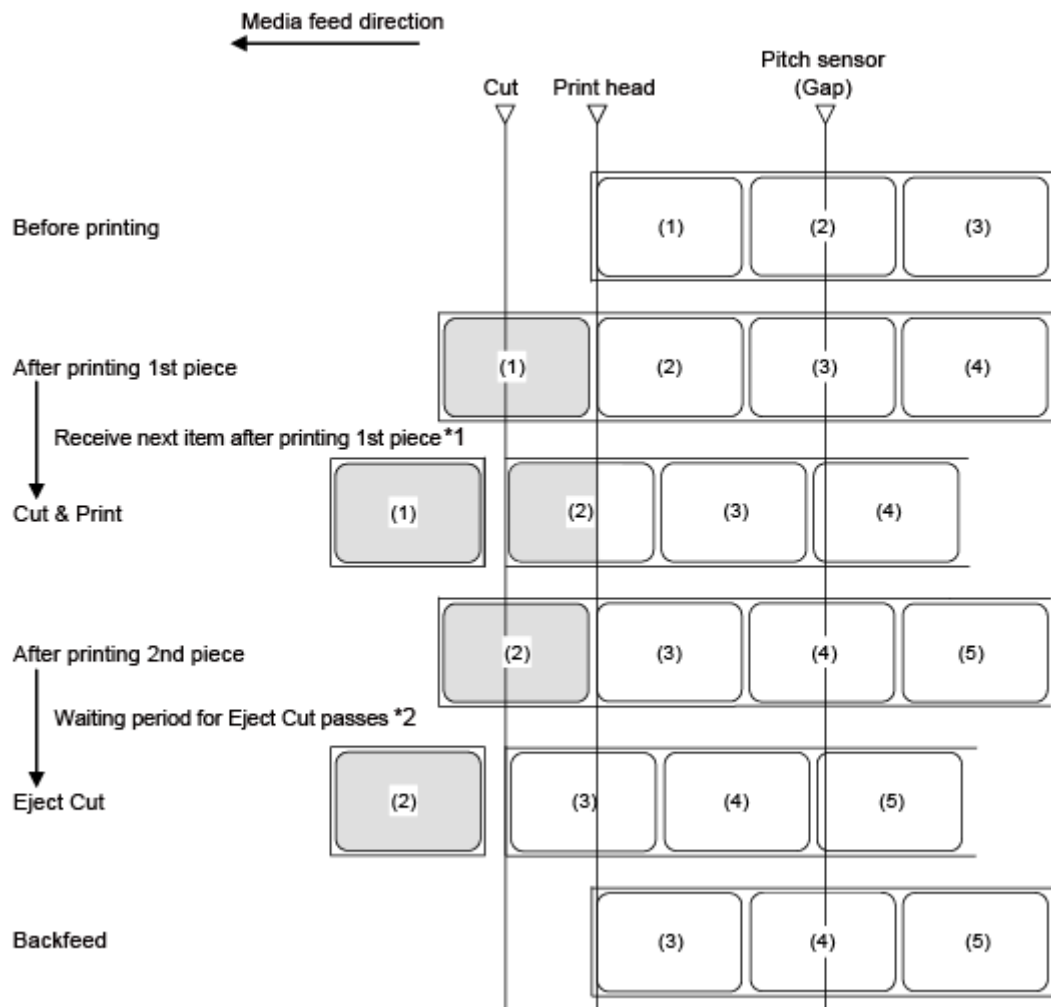

*1 After printing, if the next data is received, printing will be done and the media will be cut on the cut position.

*2 After printing, if the next data is not received and the waiting period for Eject Cut has passed, Eject Cut will be performed.



- The figure above shows the reference position when the Gap sensor is used.

Timing Chart

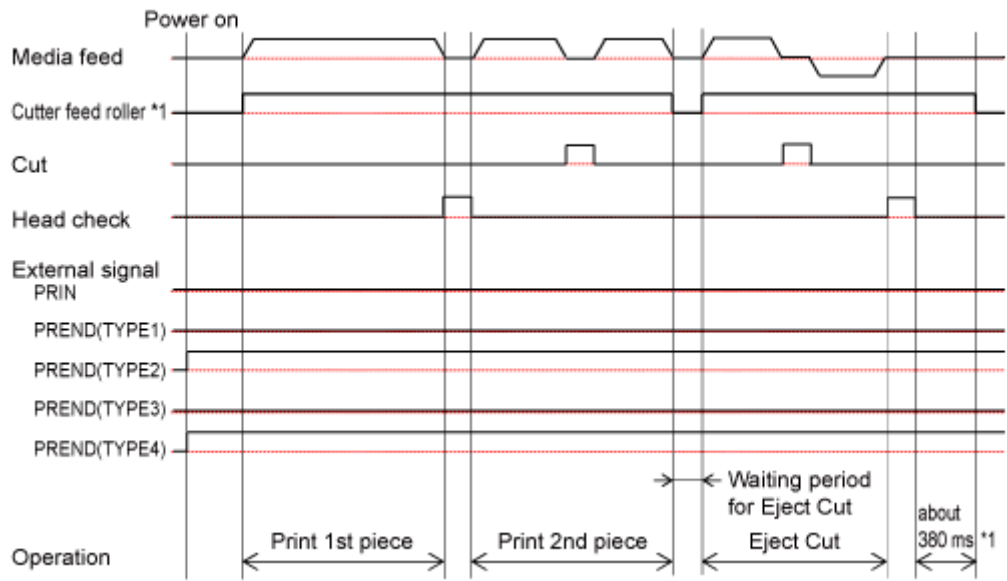

*1 This is applied when the rotary cutter unit is installed.

Cutter Mode, No Backfeed, and with Pulse Input (Head Check Disabled)

Operation

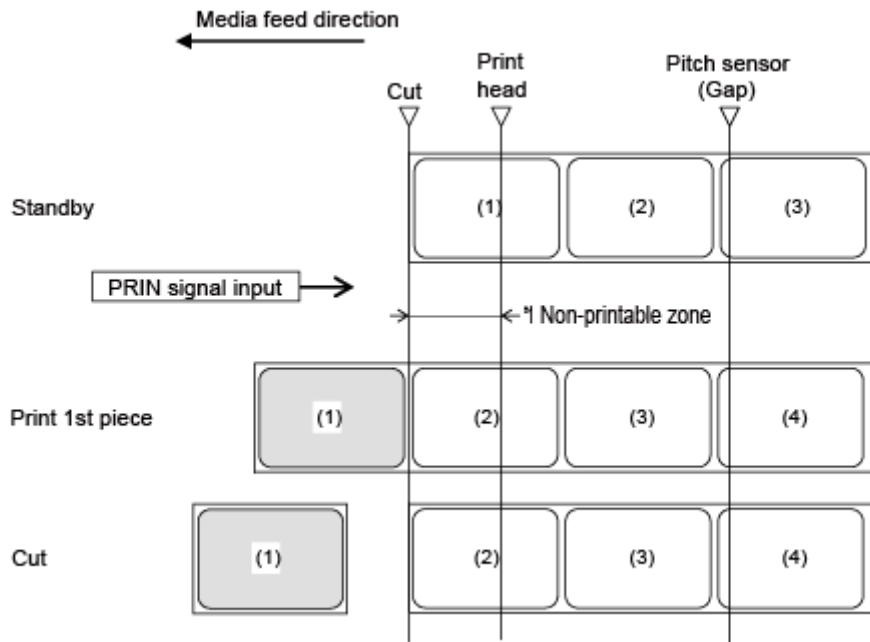

*1 Because backfeeding is not done, the media in this area is not printable.



- The figure above shows the reference position when the Gap sensor is used.

Timing Chart

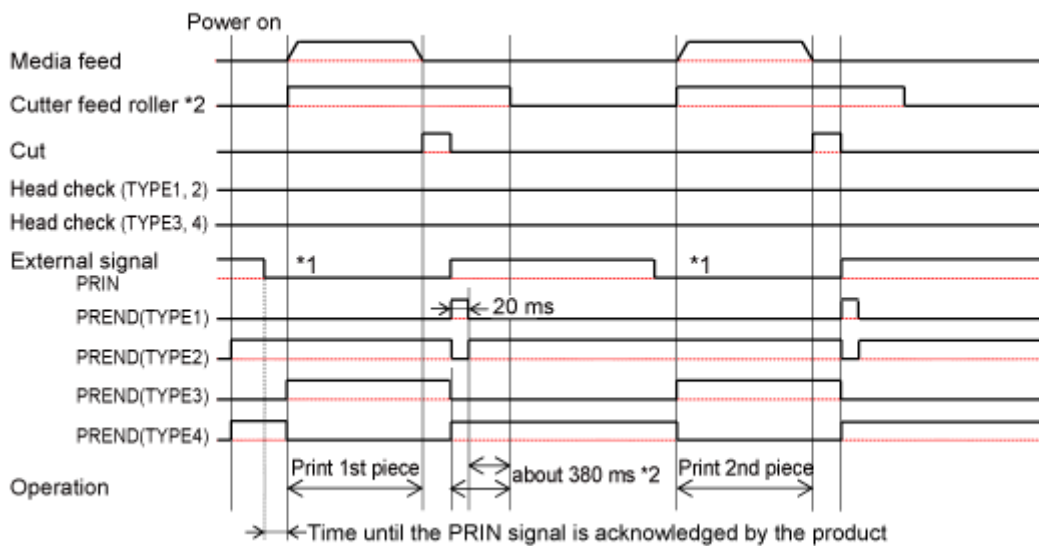

*1 Keep the PRIN signal until the PREND signal is outputted.

*2 This is applied when the rotary cutter unit is installed.

Cutter Mode, No Backfeed, and with Pulse Input (Head Check Enabled)

Operation

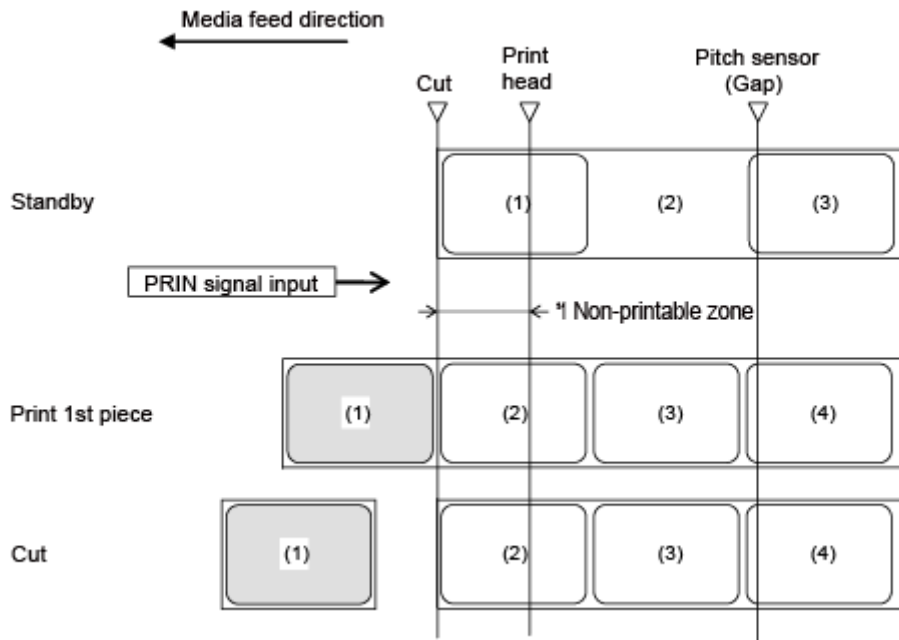

*1 Because backfeeding is not done, the media in this area is not printable.



• The figure above shows the reference position when the Gap sensor is used.

Timing Chart

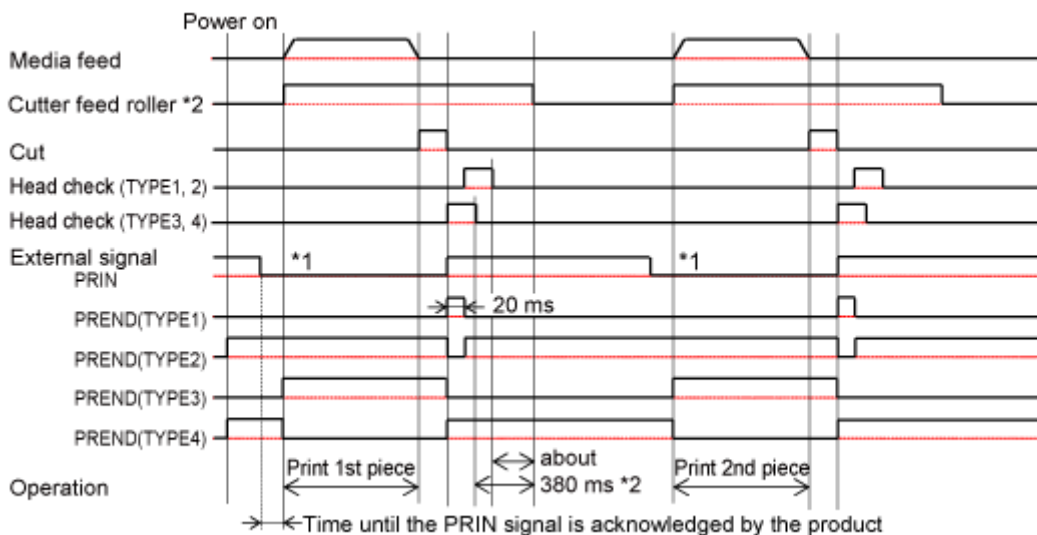

*1 Keep the PRIN signal until the PREND signal is outputted.

*2 This is applied when the rotary cutter unit is installed.

Cutter Mode, Backfeed After Printing, and with Pulse Input (Head Check Disabled)

Operation

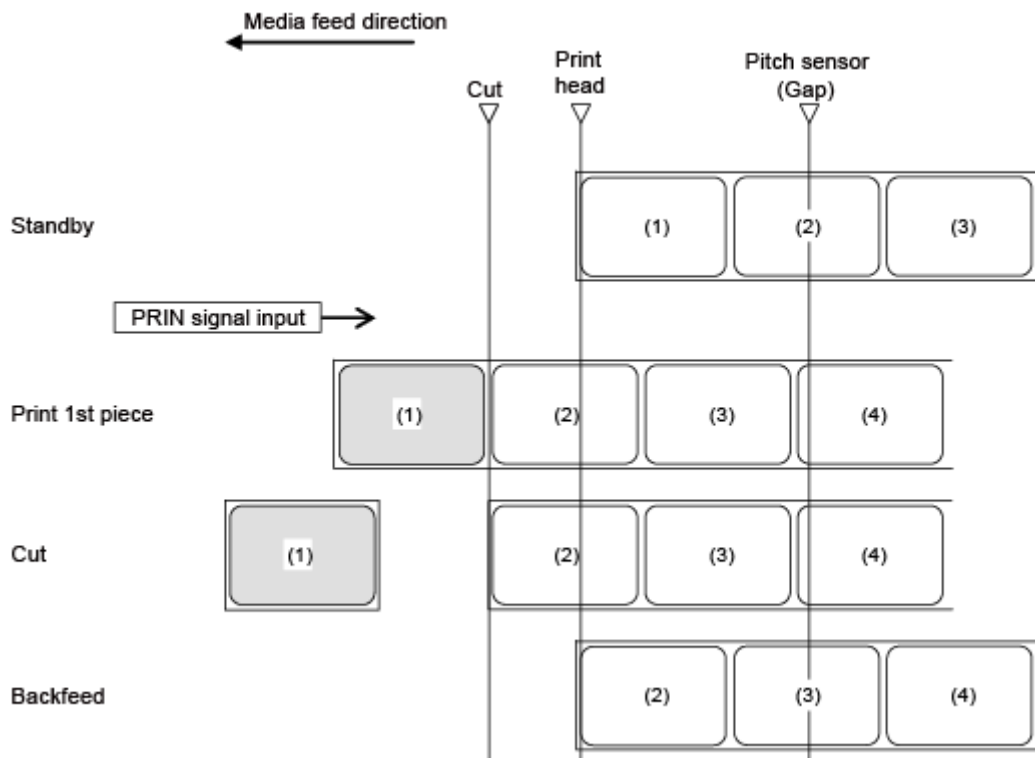

- The figure above shows the reference position when the Gap sensor is used.

Timing Chart

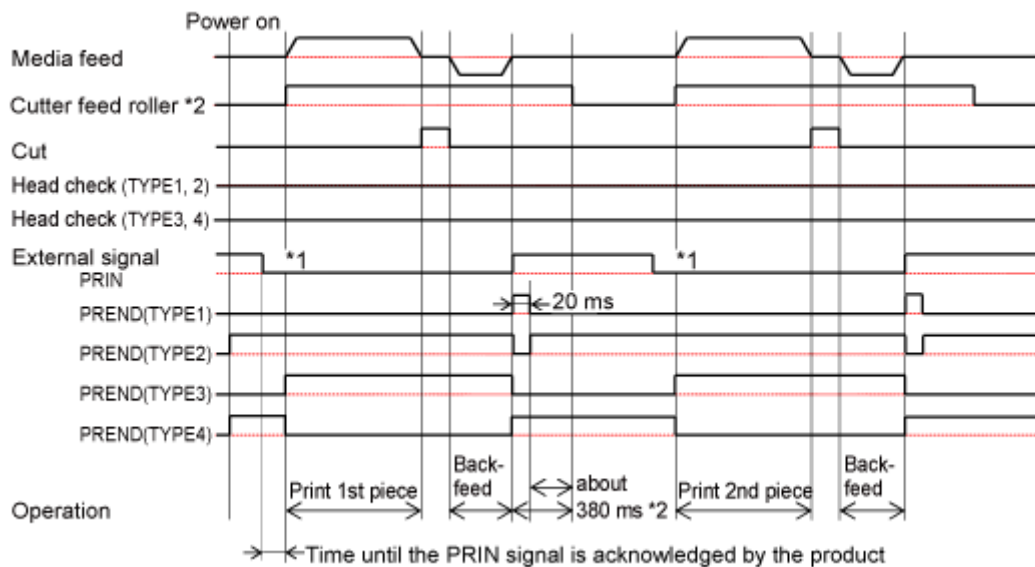

*1 Keep the PRIN signal until the PREND signal is outputted.

*2 This is applied when the rotary cutter unit is installed.

Cutter Mode, Backfeed After Printing, and with Pulse Input (Head Check Enabled)

Operation

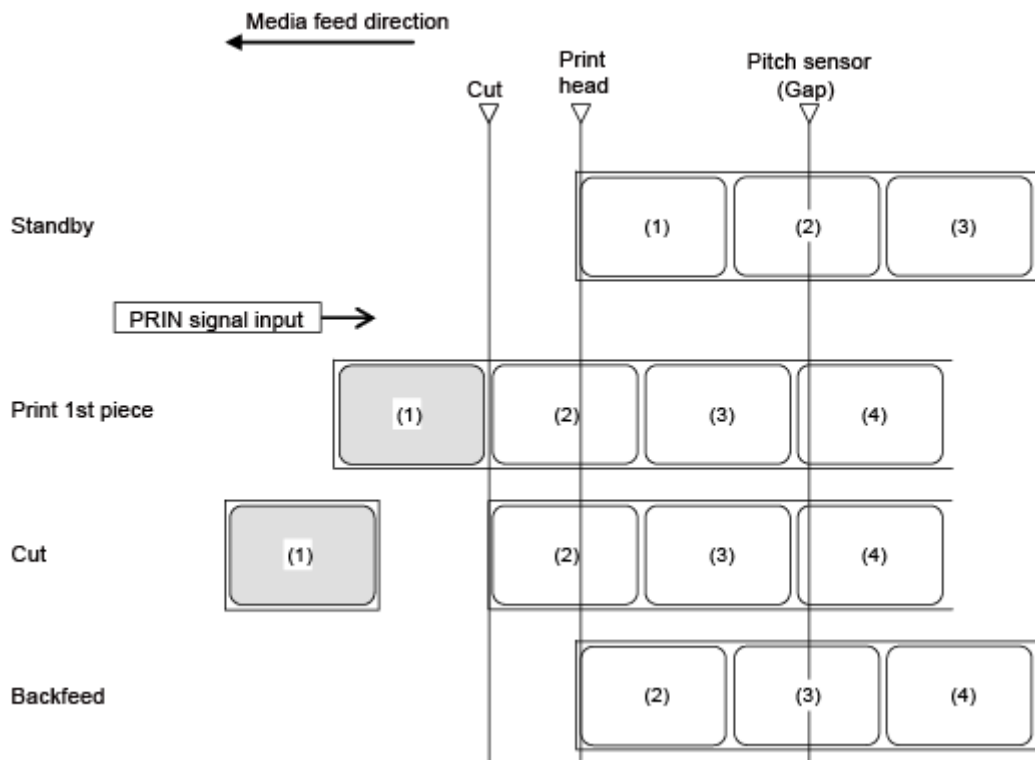

- The figure above shows the reference position when the Gap sensor is used.

Timing Chart

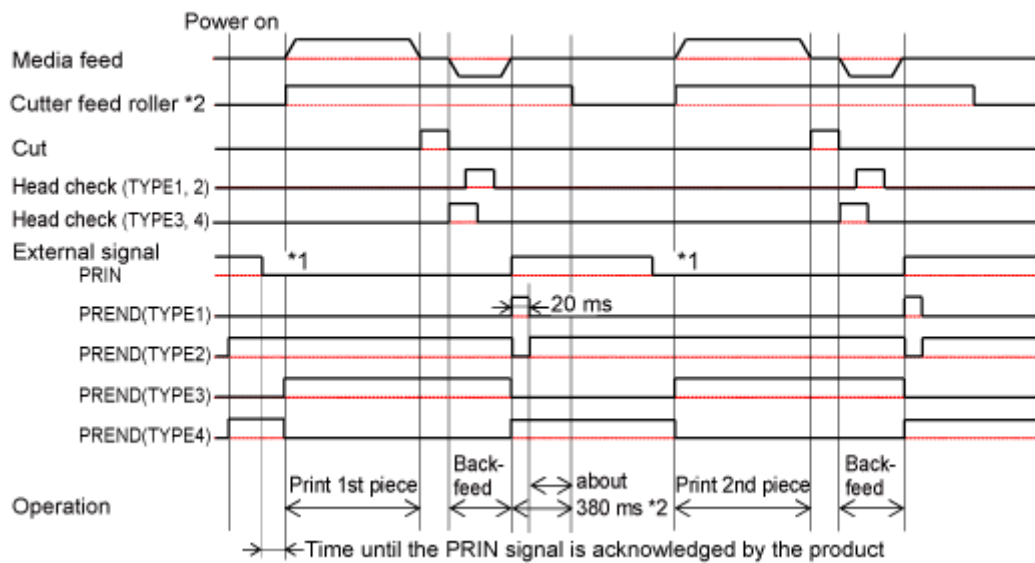

*1 Keep the PRIN signal until the PREND signal is outputted.

*2 This is applied when the rotary cutter unit is installed.

Cutter Mode, Backfeed Before Printing, and with Pulse Input (Head Check Disabled)

Operation

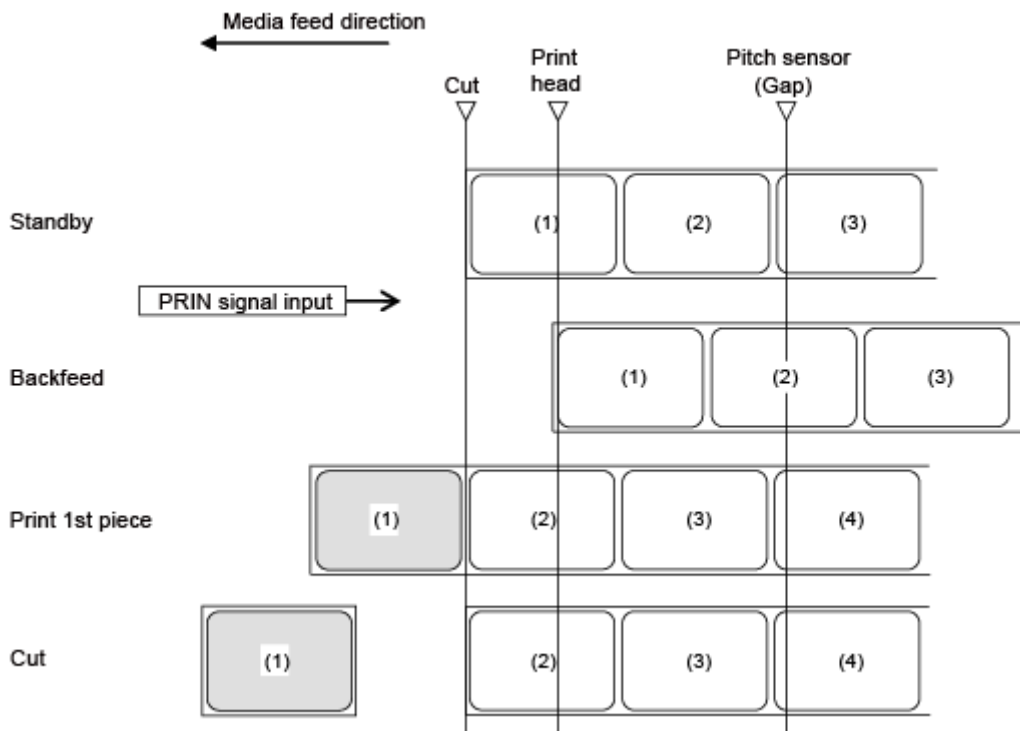

• The figure above shows the reference position when the Gap sensor is used.

Timing Chart

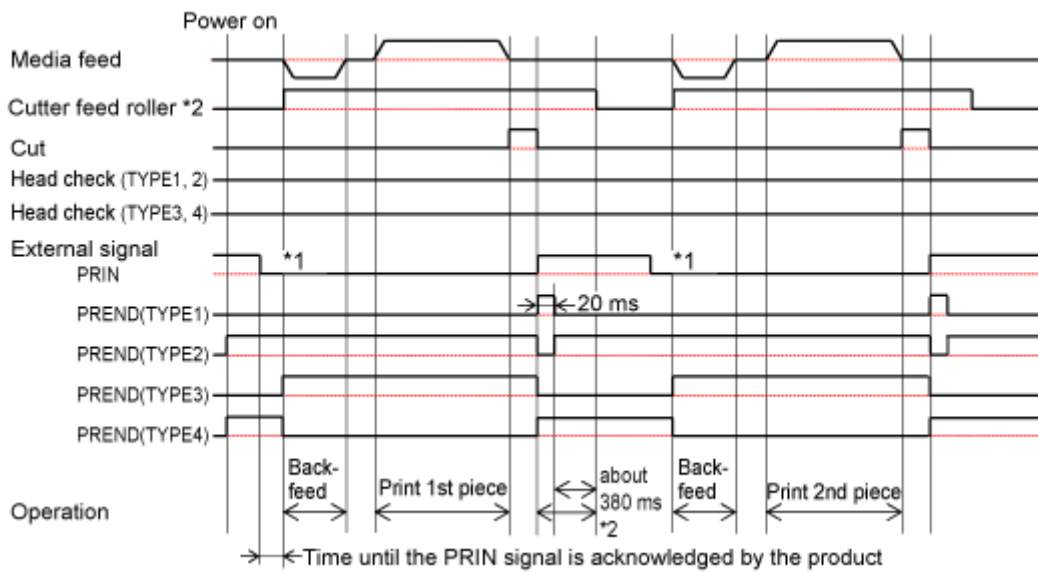

*1 Keep the PRIN signal until the PREND signal is outputted.

*2 This is applied when the rotary cutter unit is installed.

Cutter Mode, Backfeed Before Printing, and with Pulse Input (Head Check Enabled)

Operation

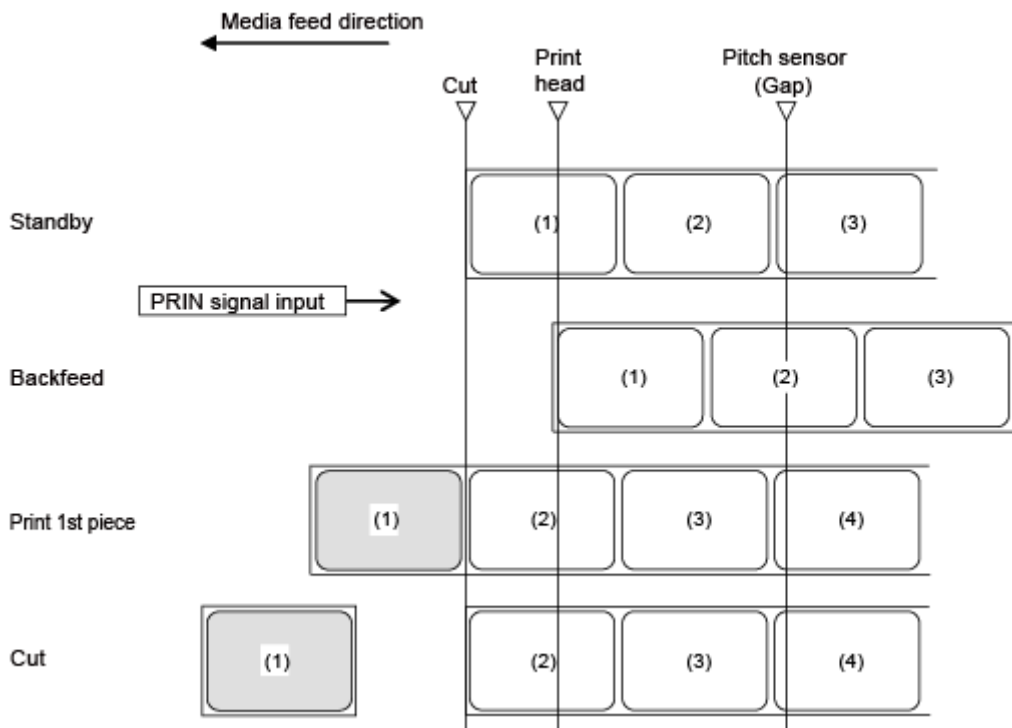

- The figure above shows the reference position when the Gap sensor is used.

Timing Chart

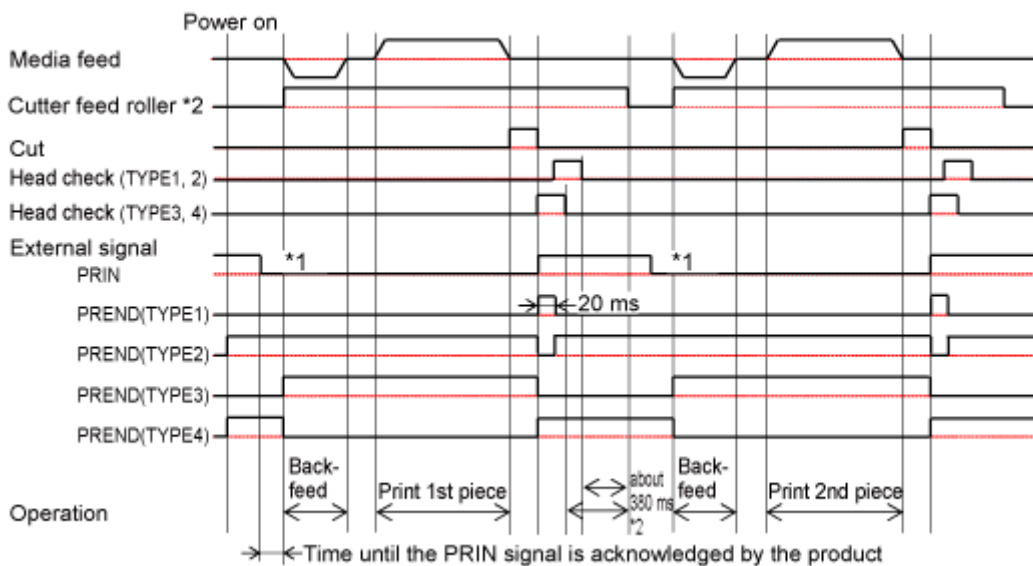

*1 Keep the PRIN signal until the PREND signal is outputted.

*2 This is applied when the rotary cutter unit is installed.

Operations in Dispenser Mode

Dispenser Mode, No Backfeed, and with Sensor Input (Head Check Disabled)

Operation

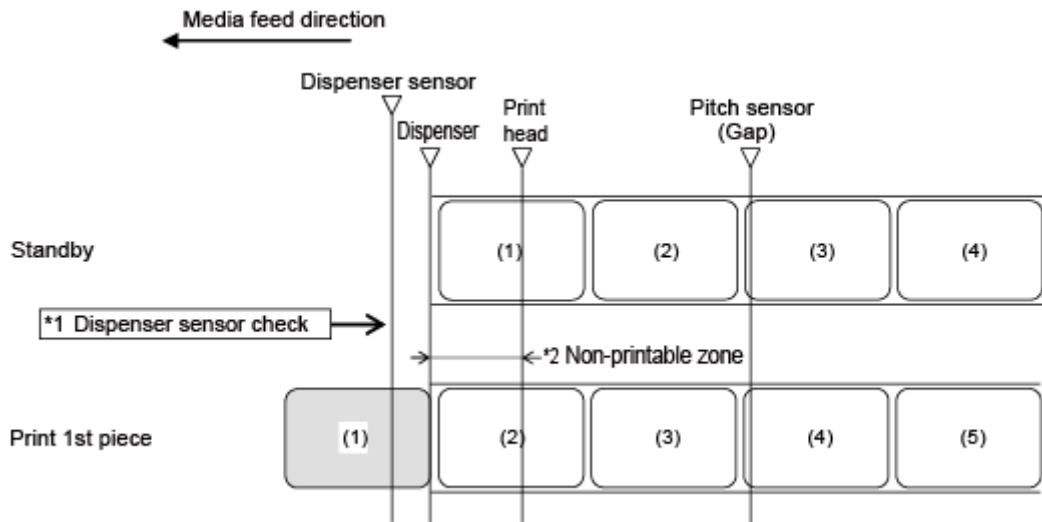

*1 The dispenser sensor confirms the dispensing condition and the product does not perform the next operation until the label is dispensed.

*2 Because backfeeding is not done, the media in this area is non-printable.



- The figure above shows the reference position when the Gap sensor is used.

Timing Chart

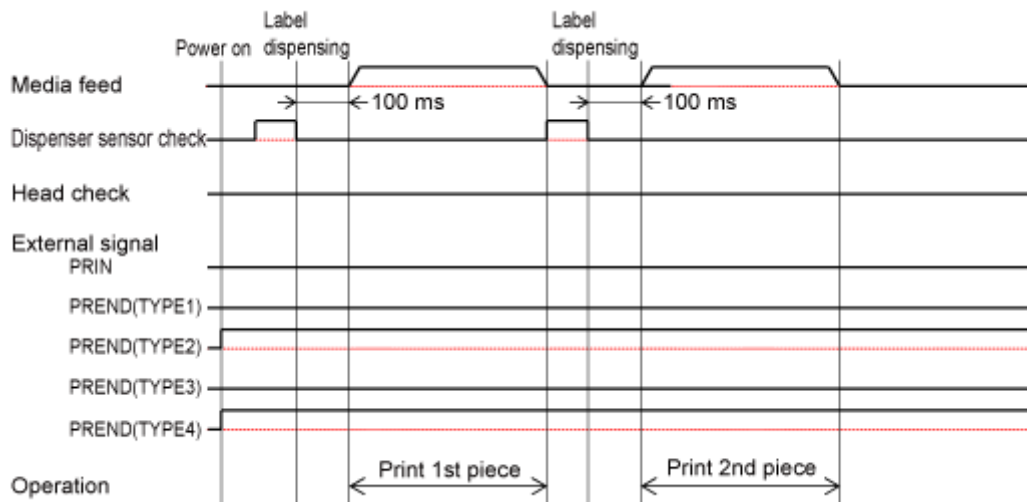

Dispenser Mode, No Backfeed, and with Sensor Input (Head Check Enabled)

Operation

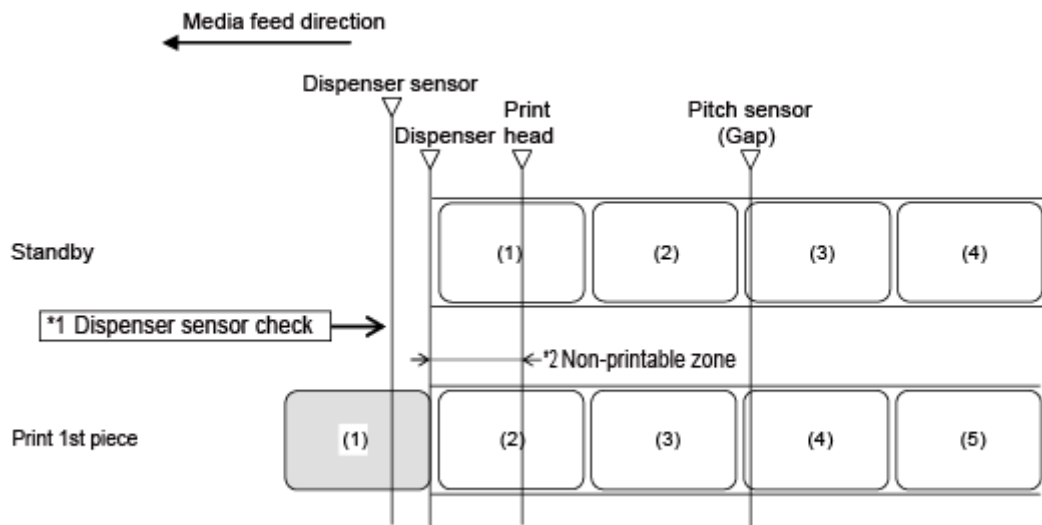

*1 The dispenser sensor confirms the dispensing condition and the product does not perform the next operation until the label is dispensed.

*2 Because backfeeding is not done, the media in this area is non-printable.



• The figure above shows the reference position when the Gap sensor is used.

Timing Chart

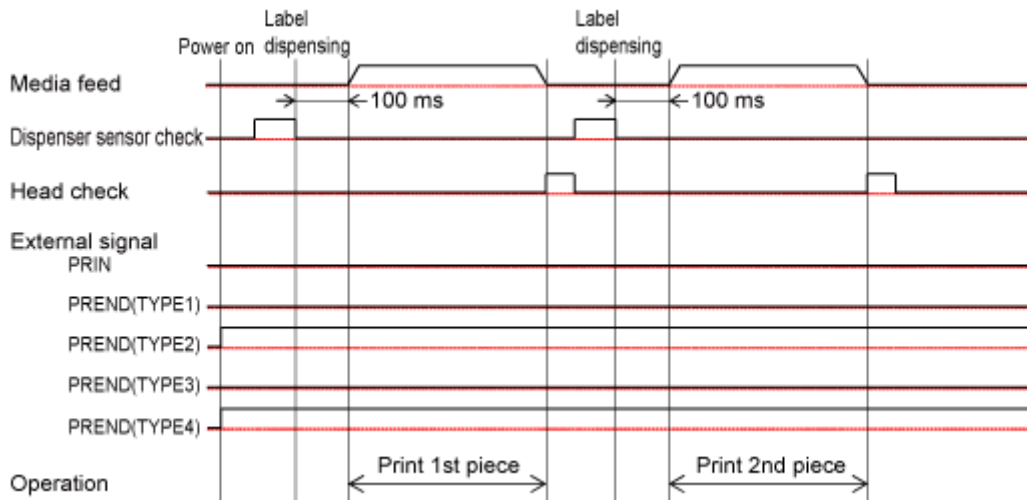

Dispenser Mode, Backfeed After Printing, and Without Pulse Input (Head Check Disabled)

Operation

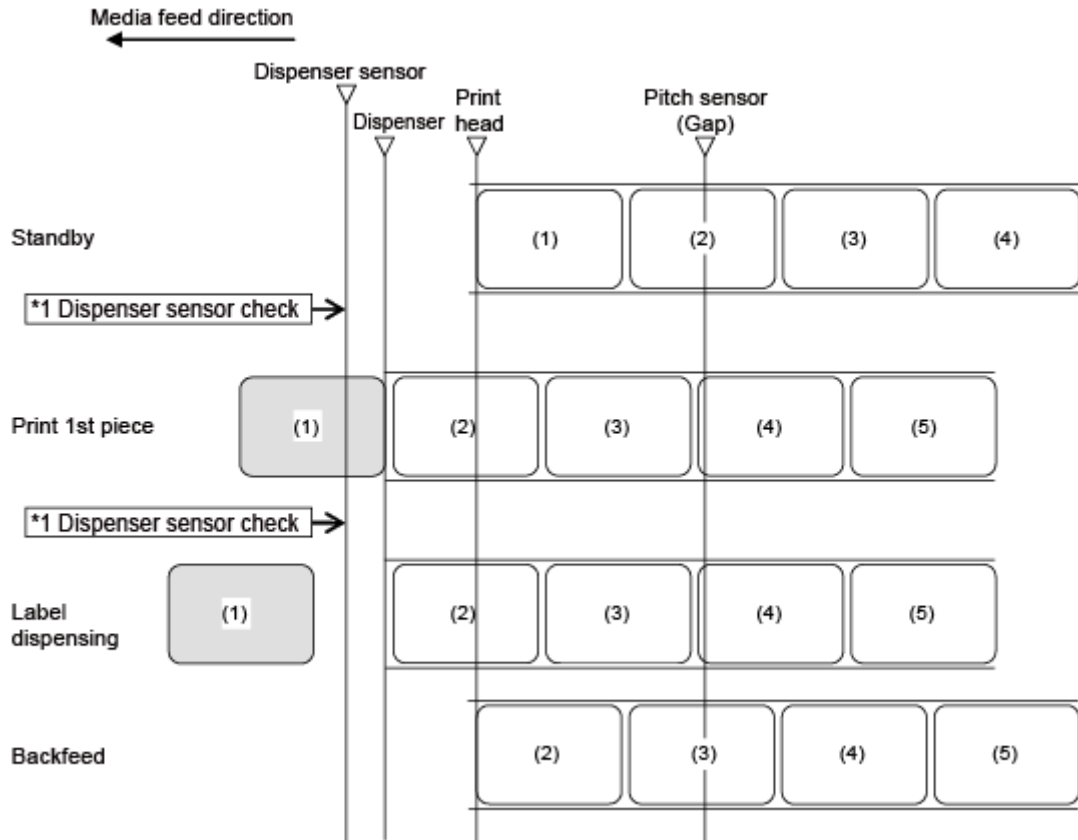

*1 The dispenser sensor confirms the dispensing condition and the product does not perform the next operation until the label is dispensed.



- The figure above shows the reference position when the Gap sensor is used.

Timing Chart

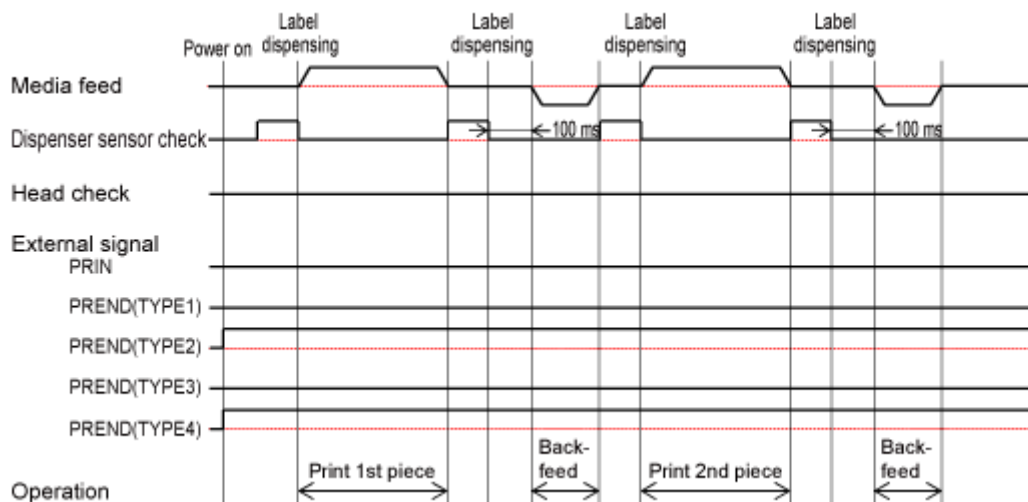

Dispenser Mode, Backfeed After Printing, and Without Pulse Input (Head Check Enabled)

Operation

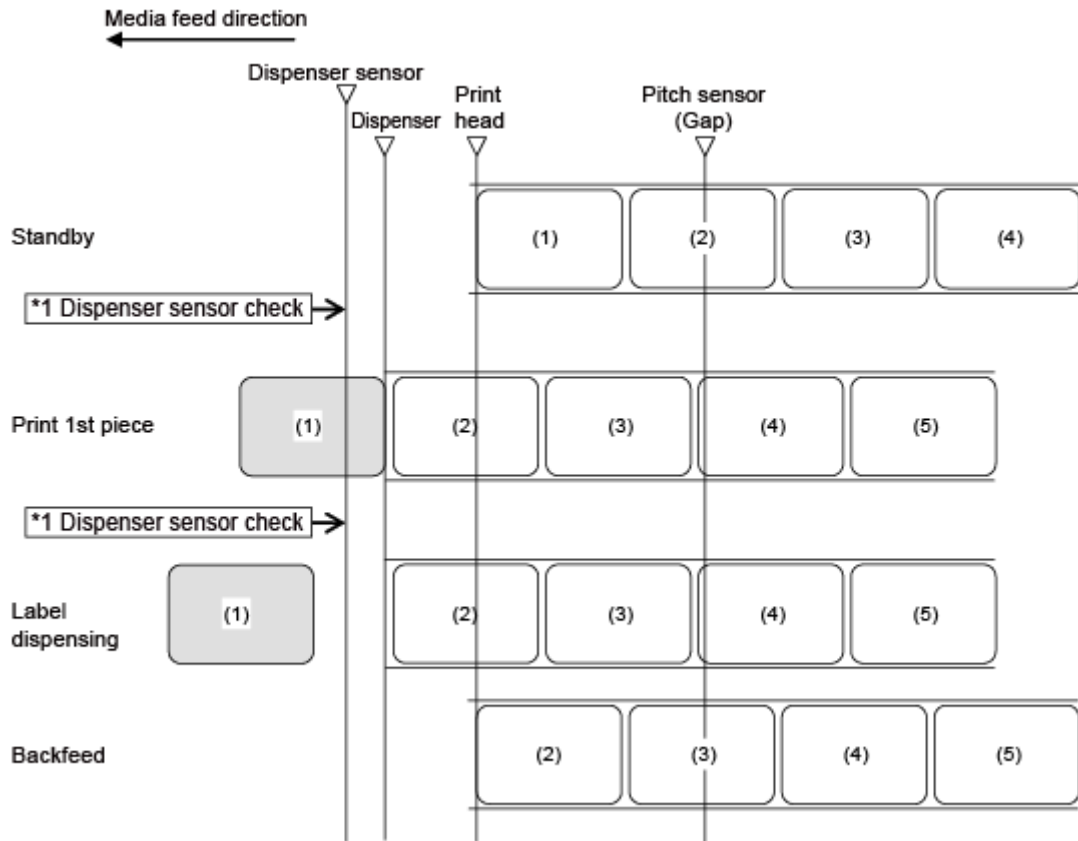

*1 The dispenser sensor confirms the dispensing condition and the product does not perform the next operation until the label is dispensed.



- The figure above shows the reference position when the Gap sensor is used.

Timing Chart

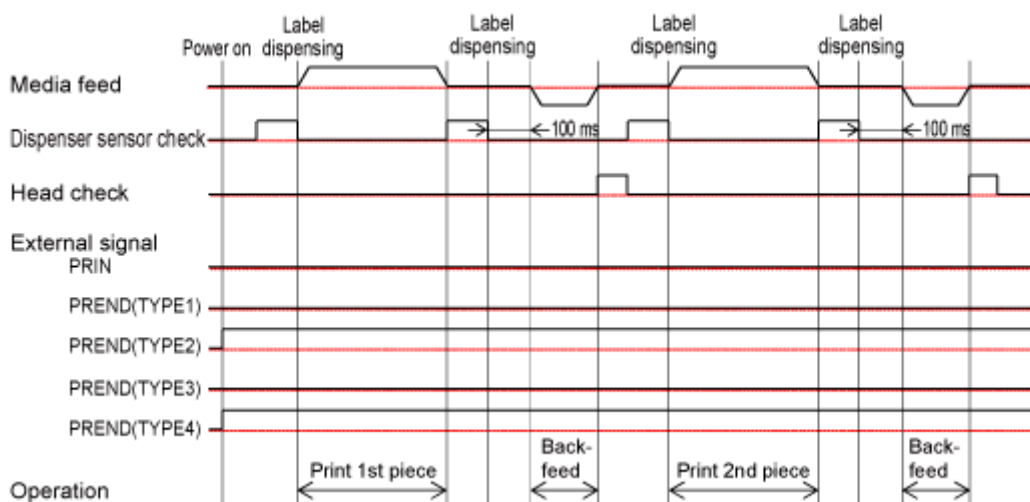

Dispenser Mode, Backfeed Before Printing, and Without Pulse Input (Head Check Disabled)

Operation

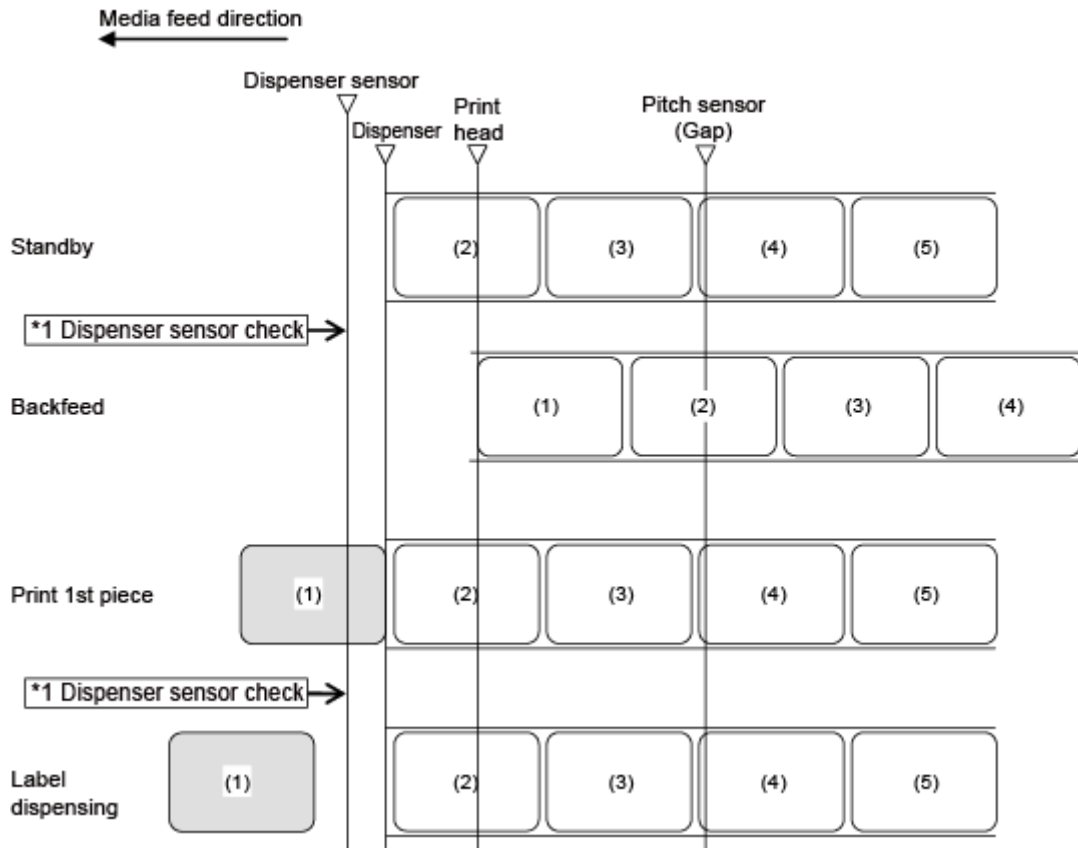

*1 The dispenser sensor confirms the dispensing condition and the product does not perform the next operation until the label is dispensed.



- The figure above shows the reference position when the Gap sensor is used.

Timing Chart

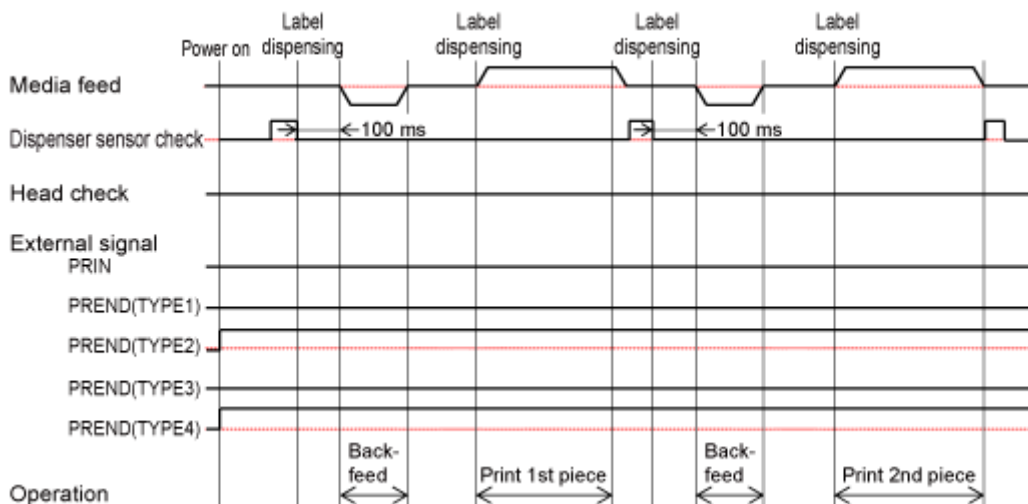

Dispenser Mode, Backfeed Before Printing, and Without Pulse Input (Head Check Enabled)

Operation

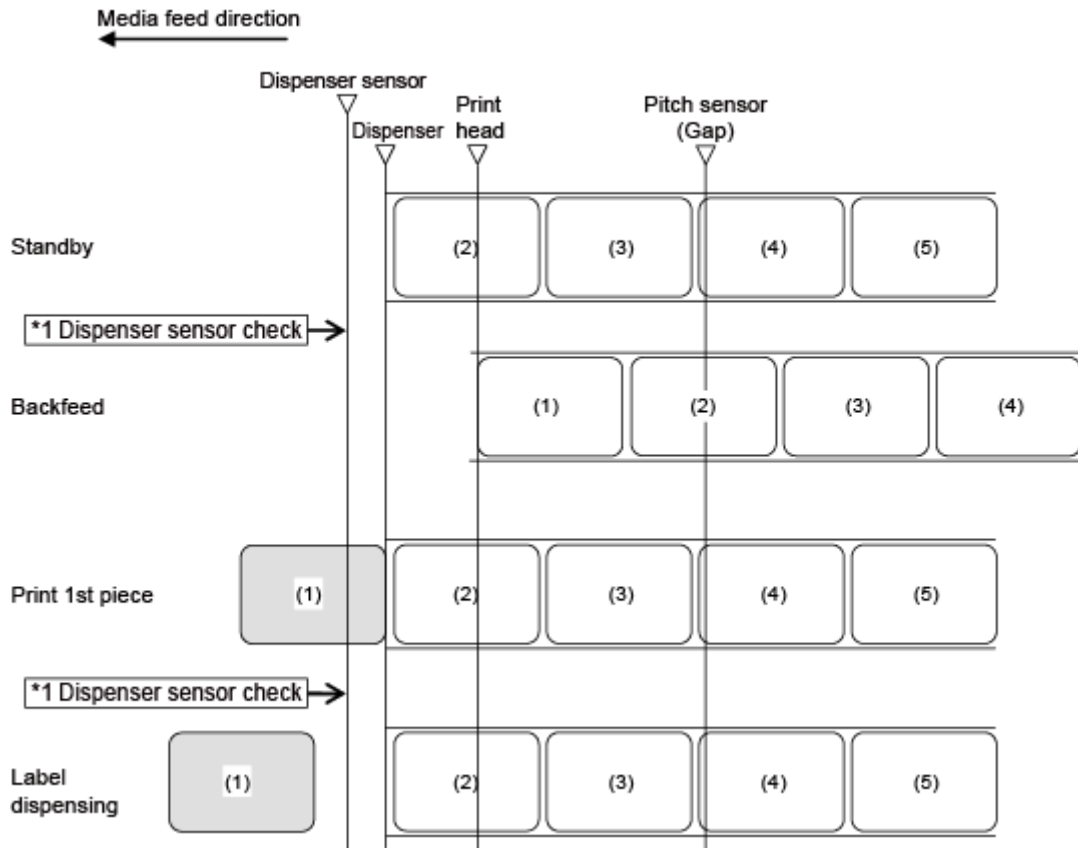

*1 The dispenser sensor confirms the dispensing condition and the product does not perform the next operation until the label is dispensed.



- The figure above shows the reference position when the Gap sensor is used.

Timing Chart

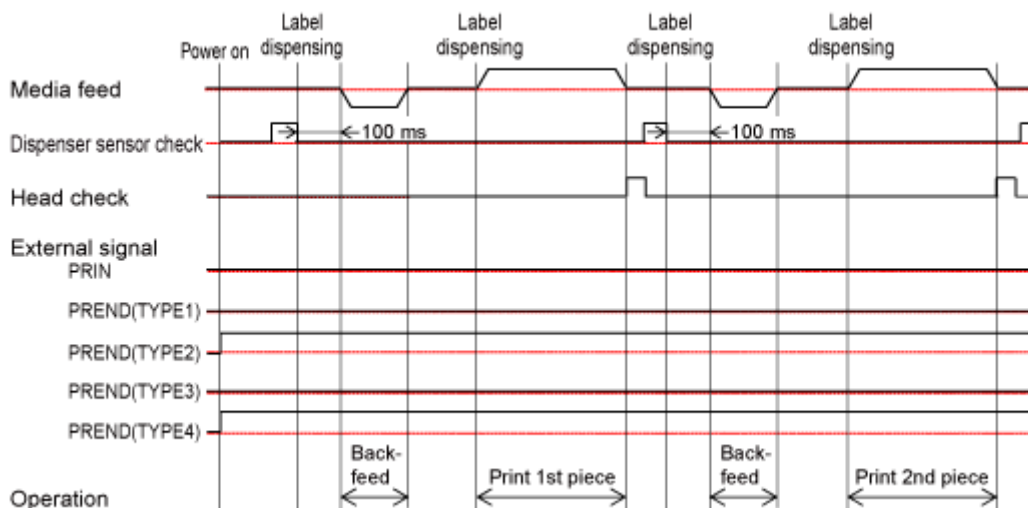

Dispenser Mode, No Backfeed, and with Pulse Input (Head Check Disabled)

Operation

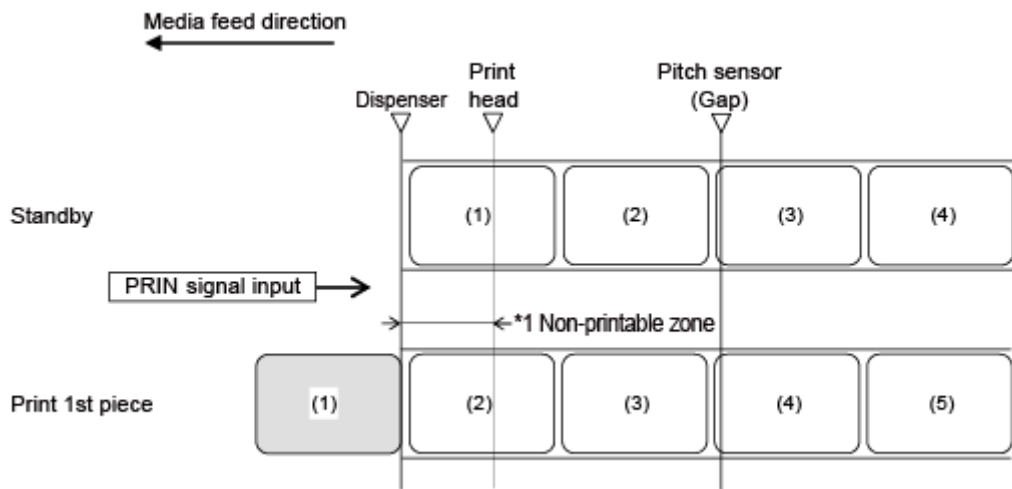

*1 Because backfeeding is not done, the media in this area is non-printable.



- The figure above shows the reference position when the Gap sensor is used.

Timing Chart

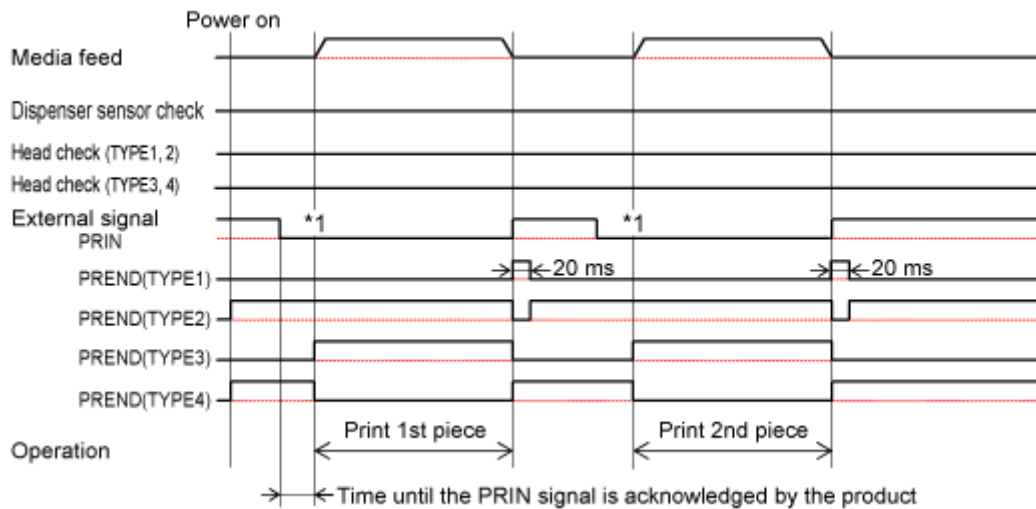

*1 Keep the PRIN signal until the PREND signal is outputted.

Dispenser Mode, No Backfeed, and with Pulse Input (Head Check Enabled)

Operation

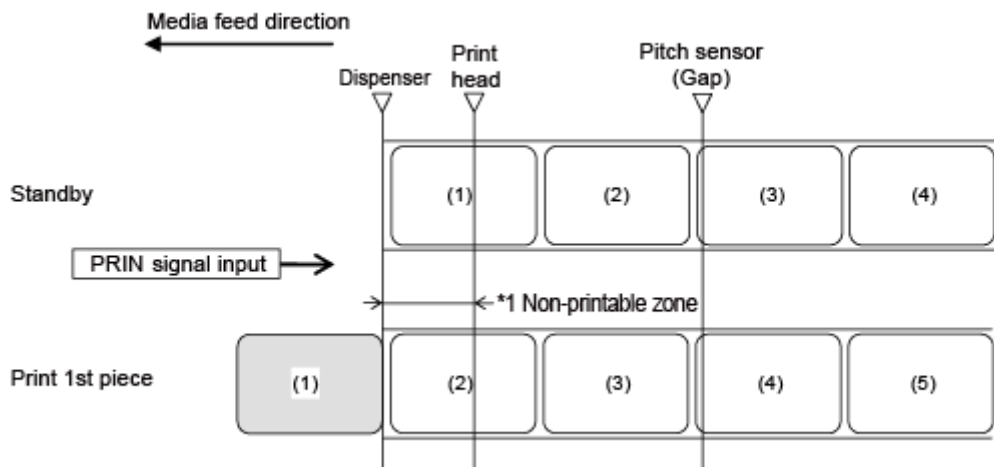

*1 Because backfeeding is not done, the media in this area is non-printable.



- The figure above shows the reference position when the Gap sensor is used.

Timing Chart

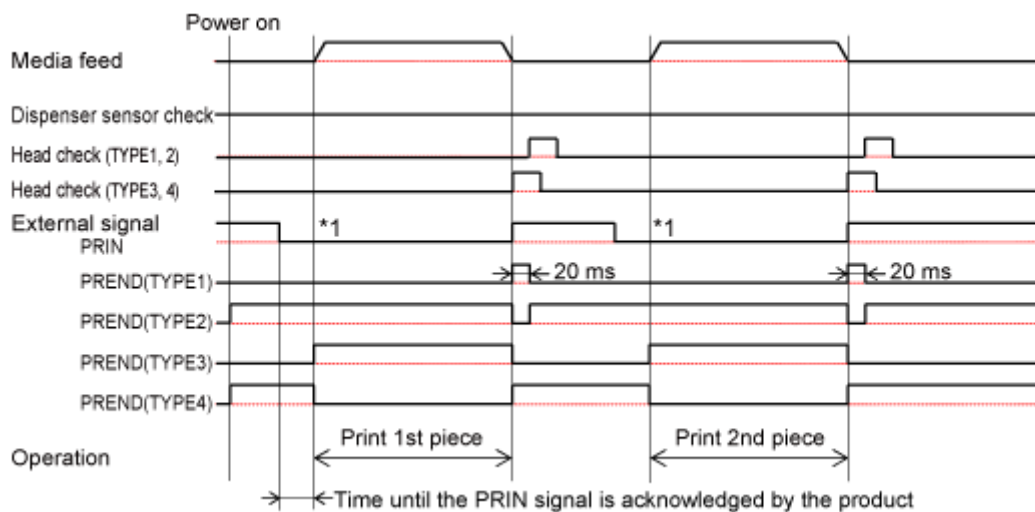

*1 Keep the PRIN signal until the PREND signal is outputted.

Dispenser Mode, Backfeed After Printing, and with Pulse Input (Head Check Disabled)

Operation

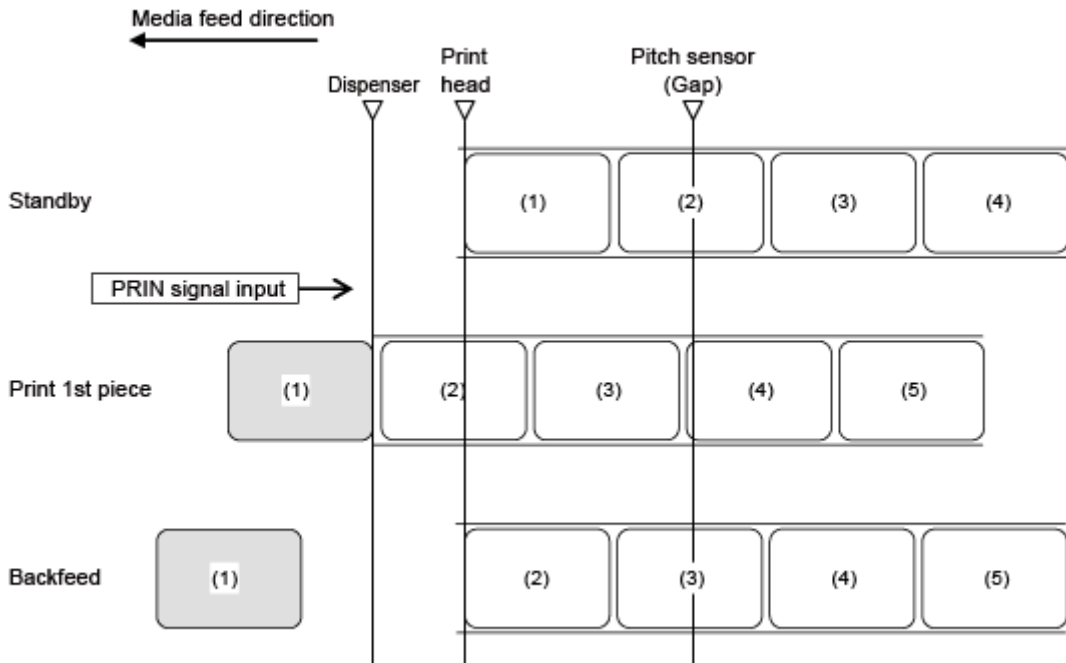

- The figure above shows the reference position when the Gap sensor is used.

Timing Chart

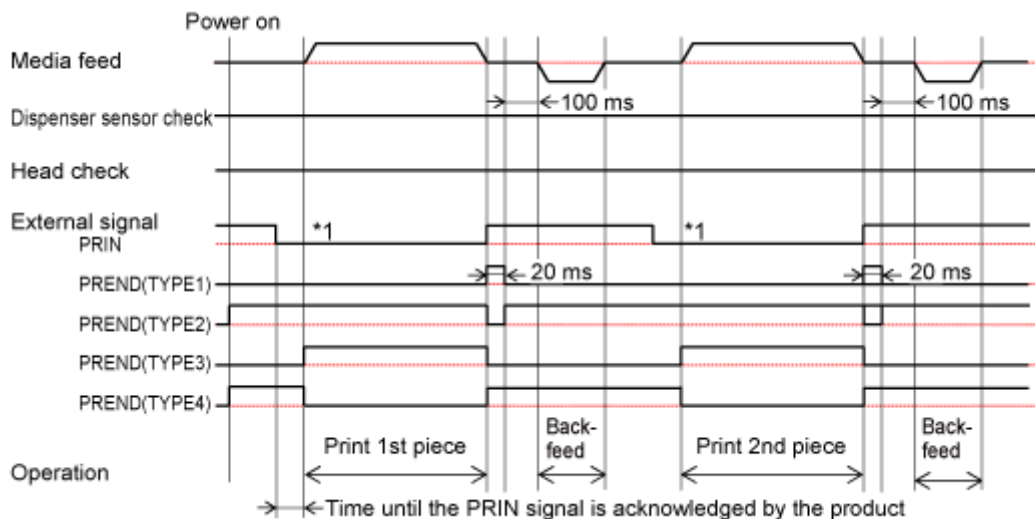

*1 Keep the PRIN signal until the PREND signal is outputted.

Dispenser Mode, Backfeed After Printing, and with Pulse Input (Head Check Enabled)

Operation

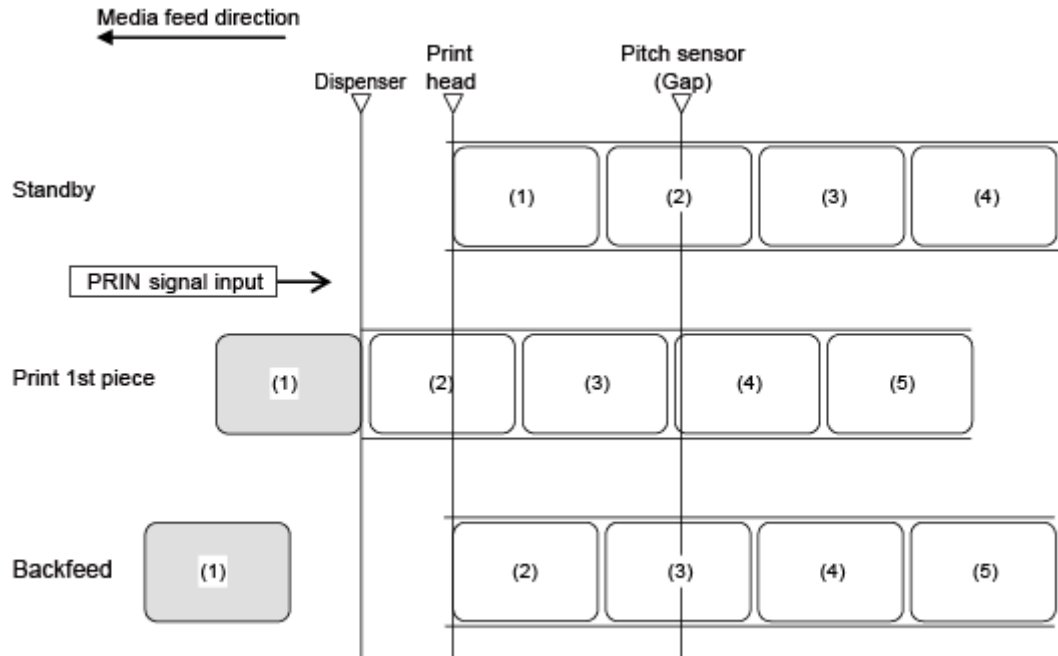

- The figure above shows the reference position when the Gap sensor is used.

Timing Chart

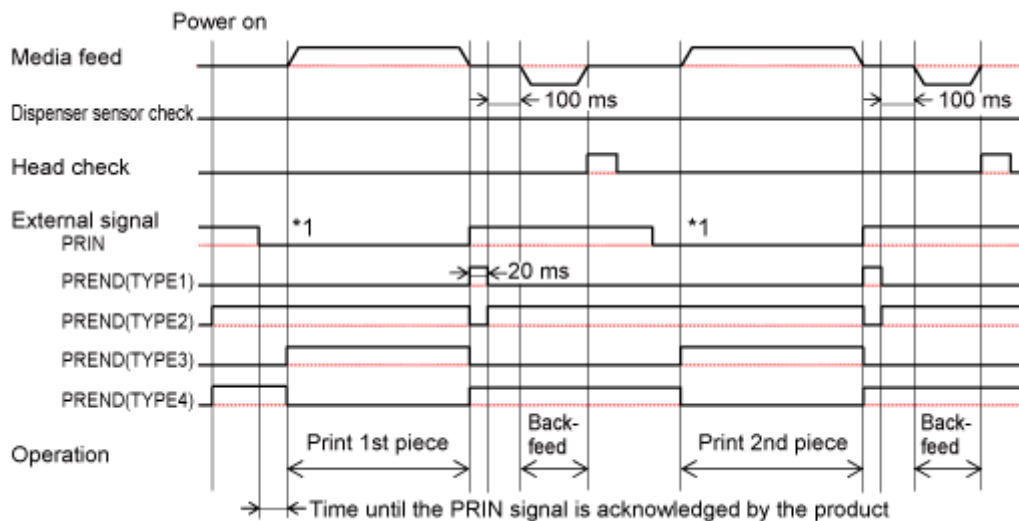

*1 Keep the PRIN signal until the PREND signal is outputted.

Dispenser Mode, Backfeed Before Printing, and with Pulse Input (Head Check Disabled)

Operation

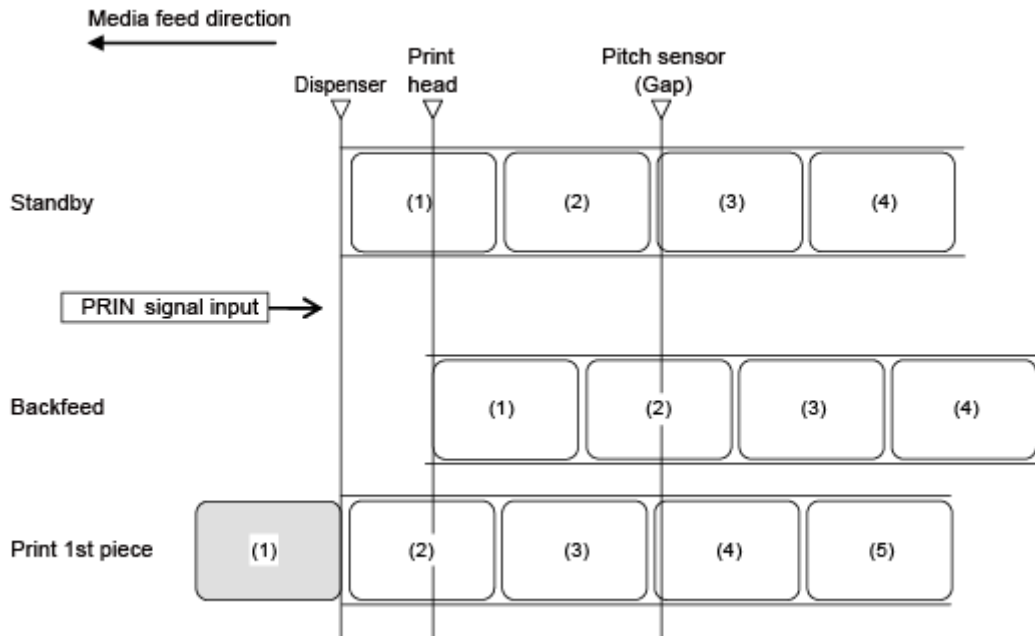

Timing Chart

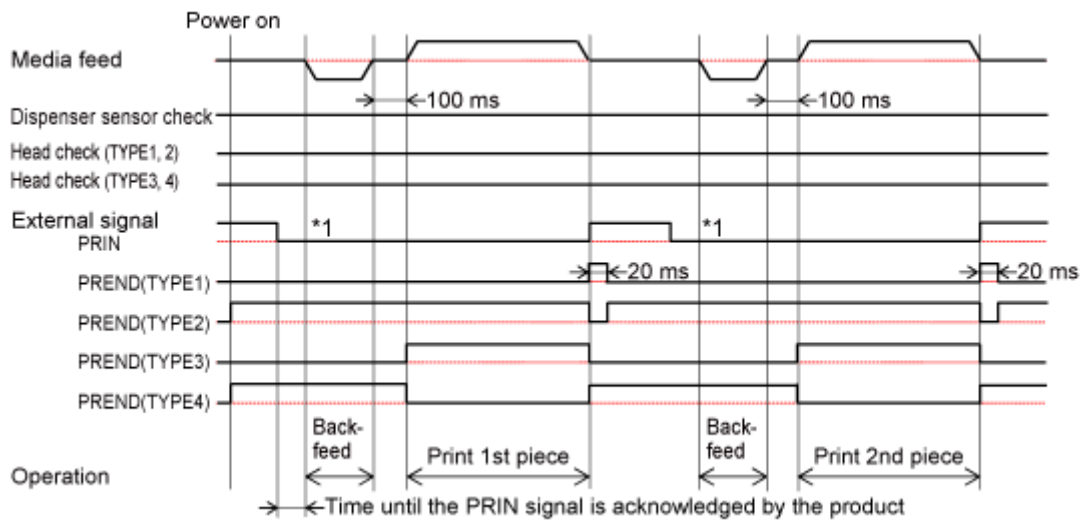

*1 Keep the PRIN signal until the PREND signal is outputted.

Dispenser Mode, Backfeed Before Printing, and with Pulse Input (Head Check Enabled)

Operation

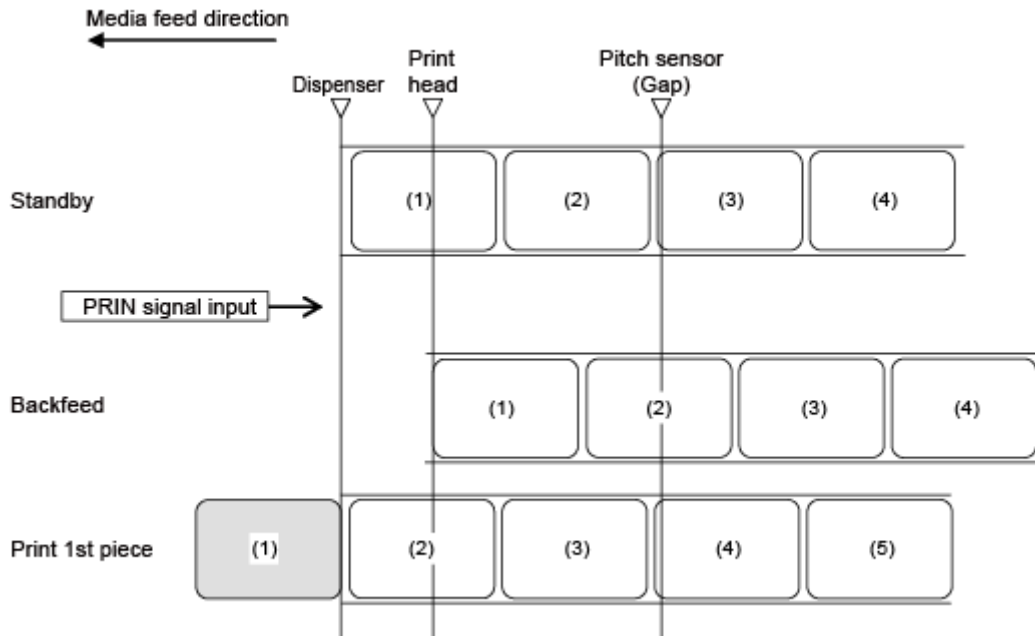

Timing Chart

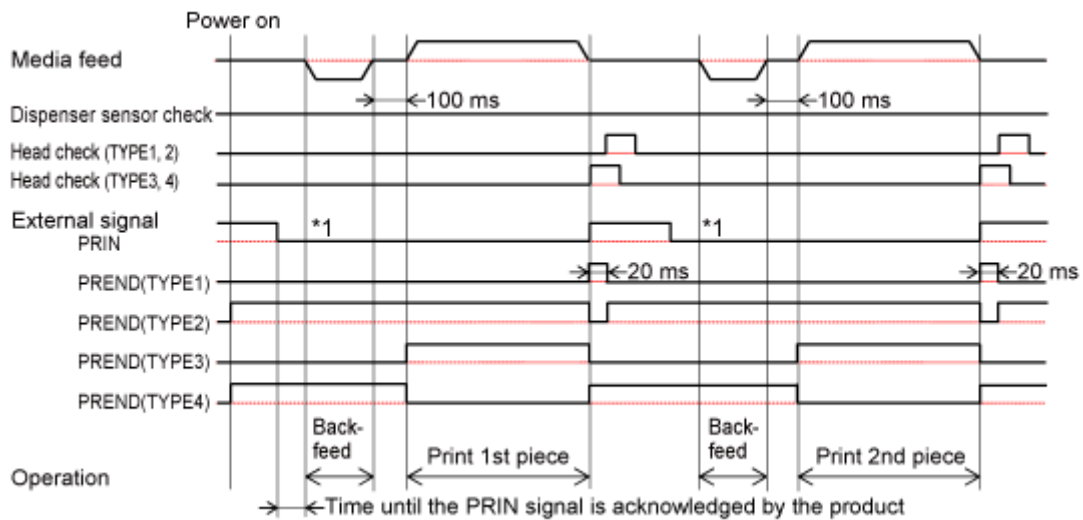

*1 Keep the PRIN signal until the PREND signal is outputted.

Dispenser Mode, Backfeed After Printing, with Pulse Input, and with the Dispenser Completion Signal (Head Check Disabled)

Operation

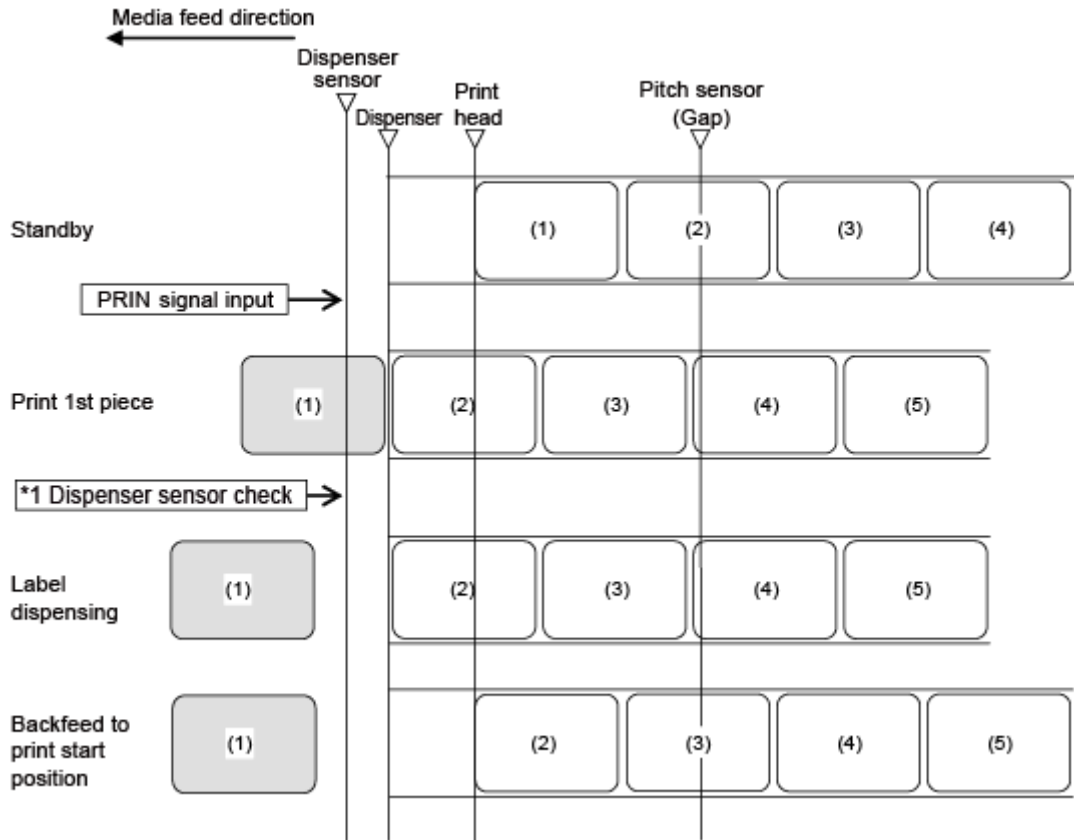

*1 The dispenser sensor confirms the dispensing condition and the product does not perform the next operation until the label is dispensed.

Timing Chart

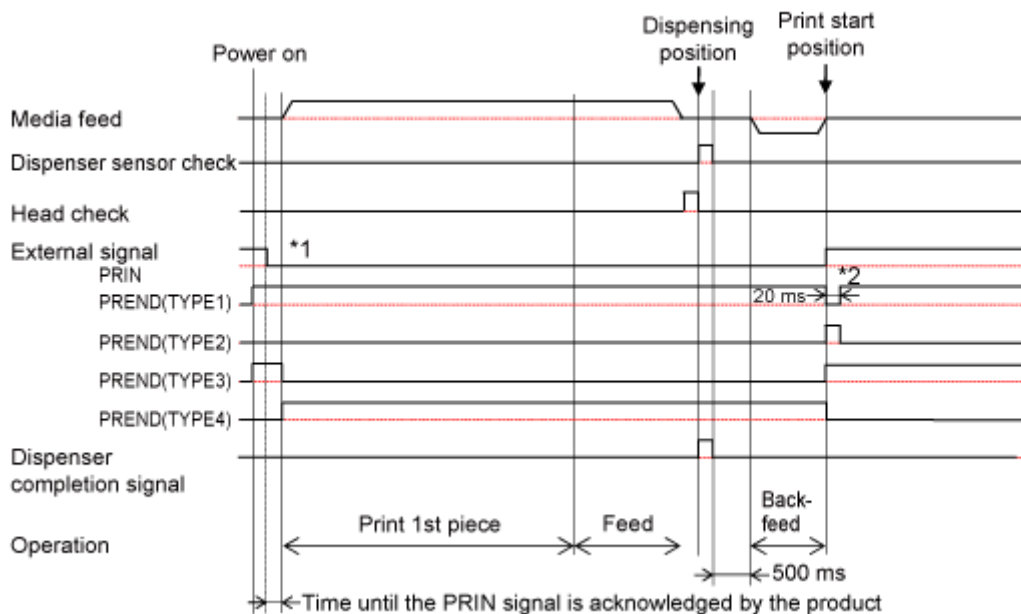

*1 Keep the PRIN signal until the PREND signal is outputted.

*2 After backfeed, the PREND signal is outputted.

Dispenser Mode, Backfeed After Printing, with Pulse Input, and with the Dispenser Completion Signal (Head Check Enabled)

Operation

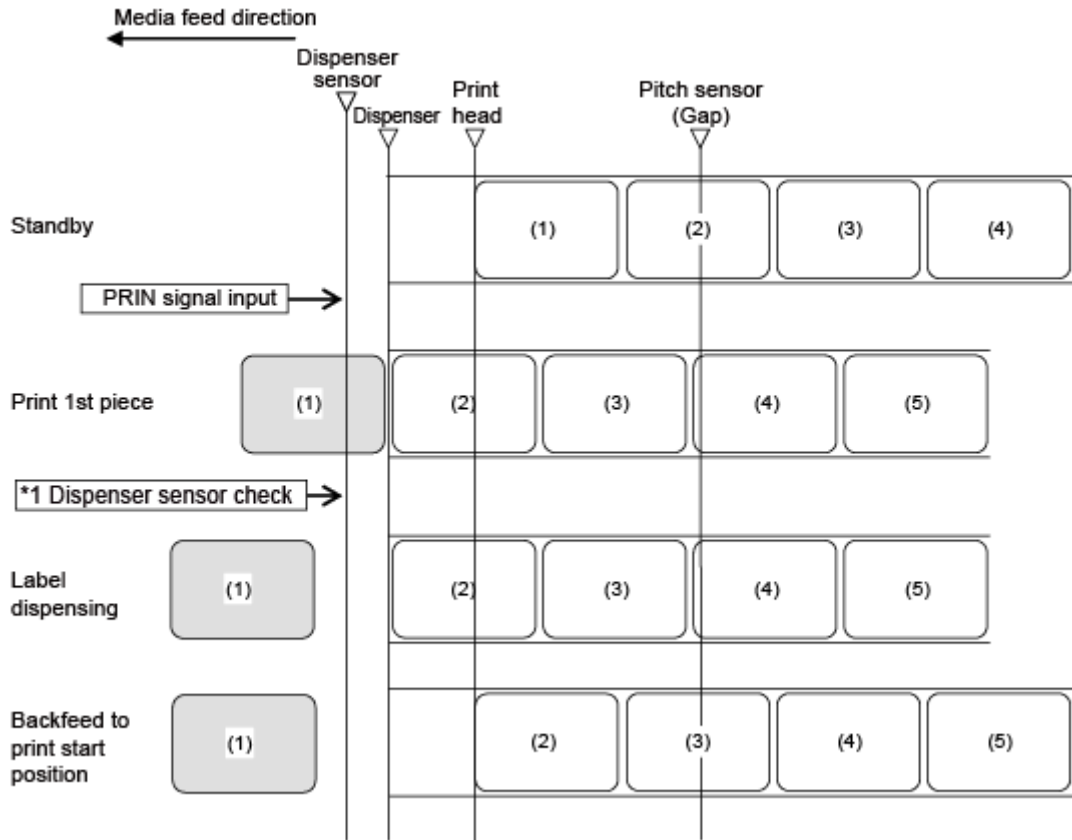

*1 The dispenser sensor confirms the dispensing condition and the product does not perform the next operation until the label is dispensed.

Timing Chart

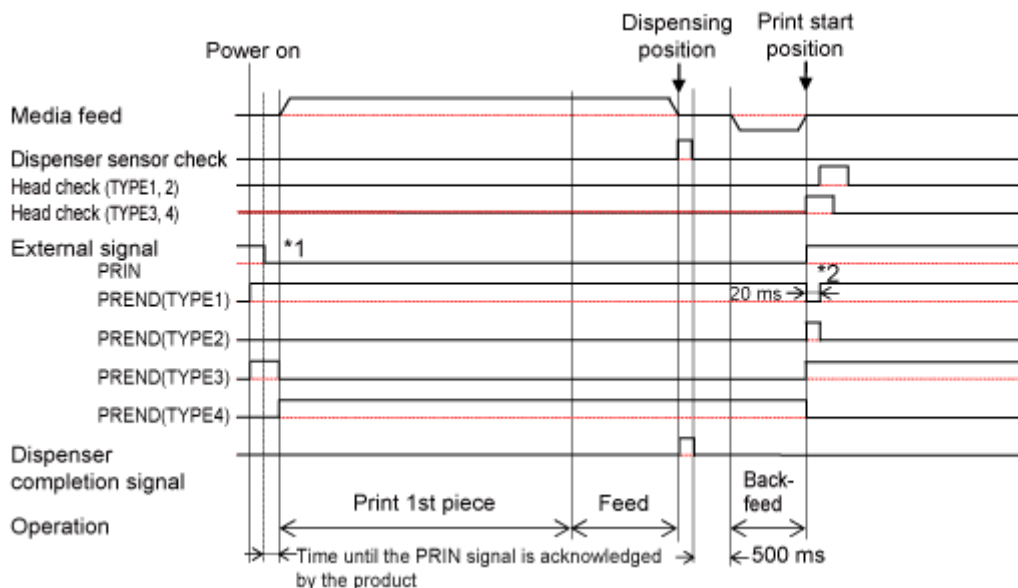

*1 Keep the PRIN signal until the PREND signal is outputted.

*2 After backfeed, the PREND signal is outputted.

Dispenser Mode, Backfeed Before Printing, with Pulse Input, and with the Dispenser Completion Signal (Head Check Disabled)

Operation

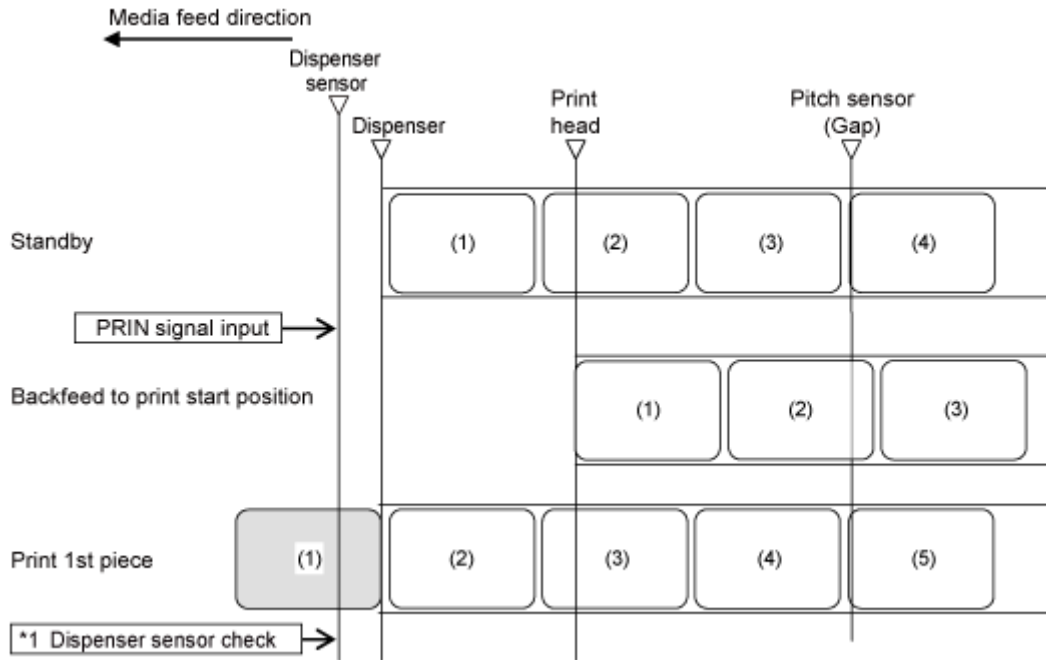

*1 The dispenser sensor confirms the dispensing condition and the product does not perform the next operation until the label is dispensed.

Timing Chart

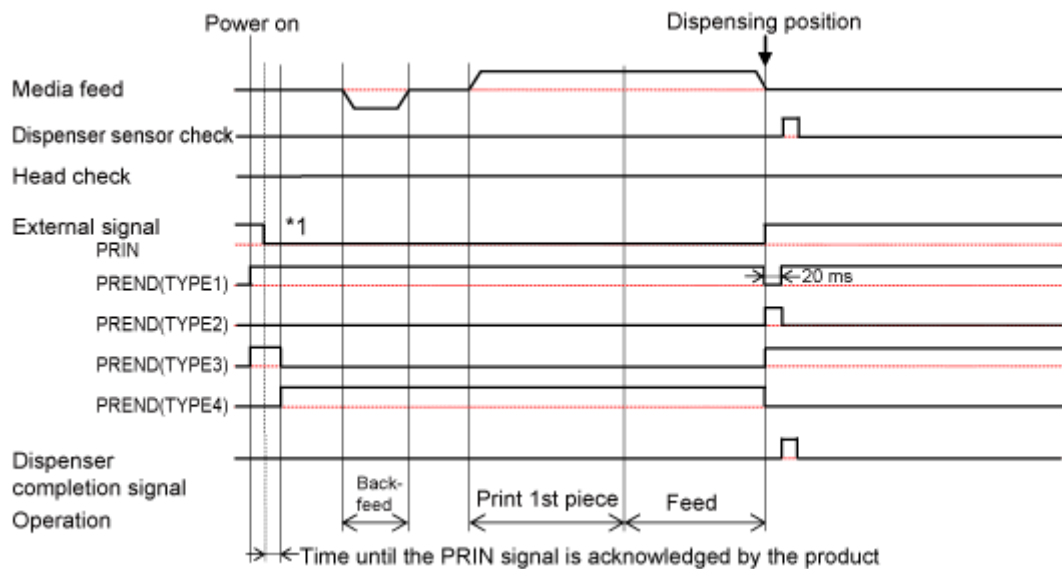

*1 Keep the PRIN signal until the PREND signal is outputted.

Dispenser Mode, Backfeed Before Printing, with Pulse Input, and with the Dispenser Completion Signal (Head Check Enabled)

Operation

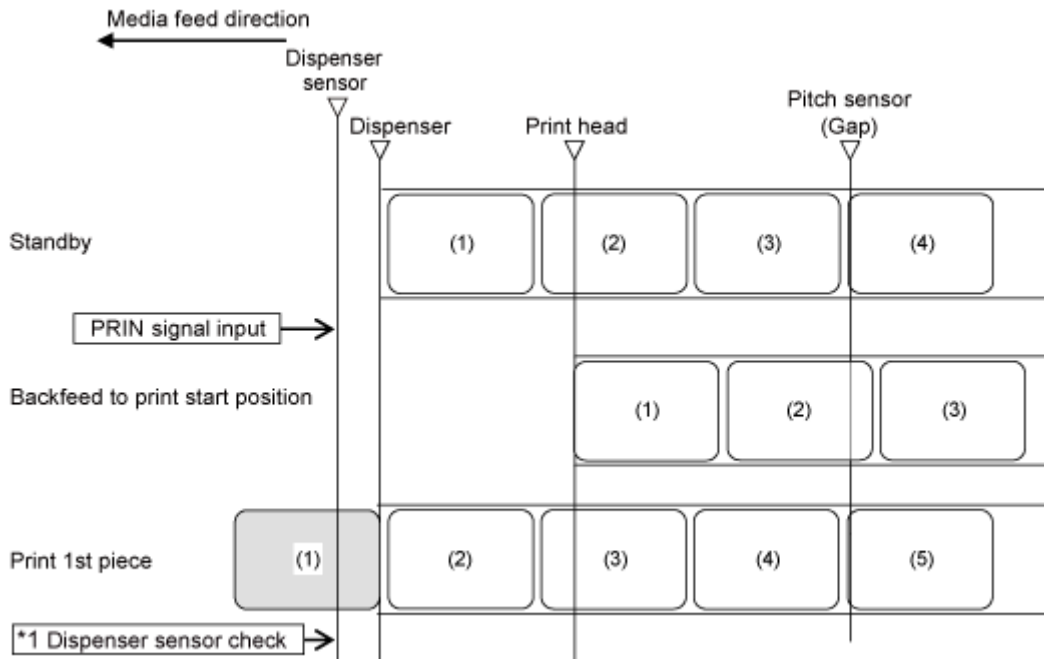

*1 The dispenser sensor confirms the dispensing condition and the product does not perform the next operation until the label is dispensed.

Timing Chart

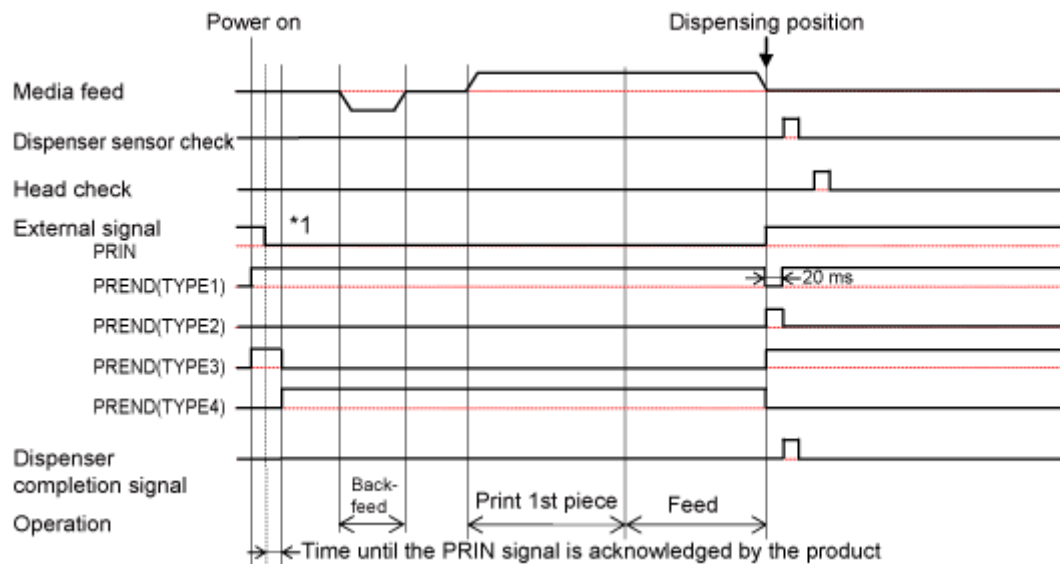

*1 Keep the PRIN signal until the PREND signal is outputted.

Operations in Linerless Mode (CL4NX Plus Only)

Linerless Mode, Backfeed Before Printing, and Without Pulse Input (Head Check Disabled) (CL4NX Plus Only)

Operation

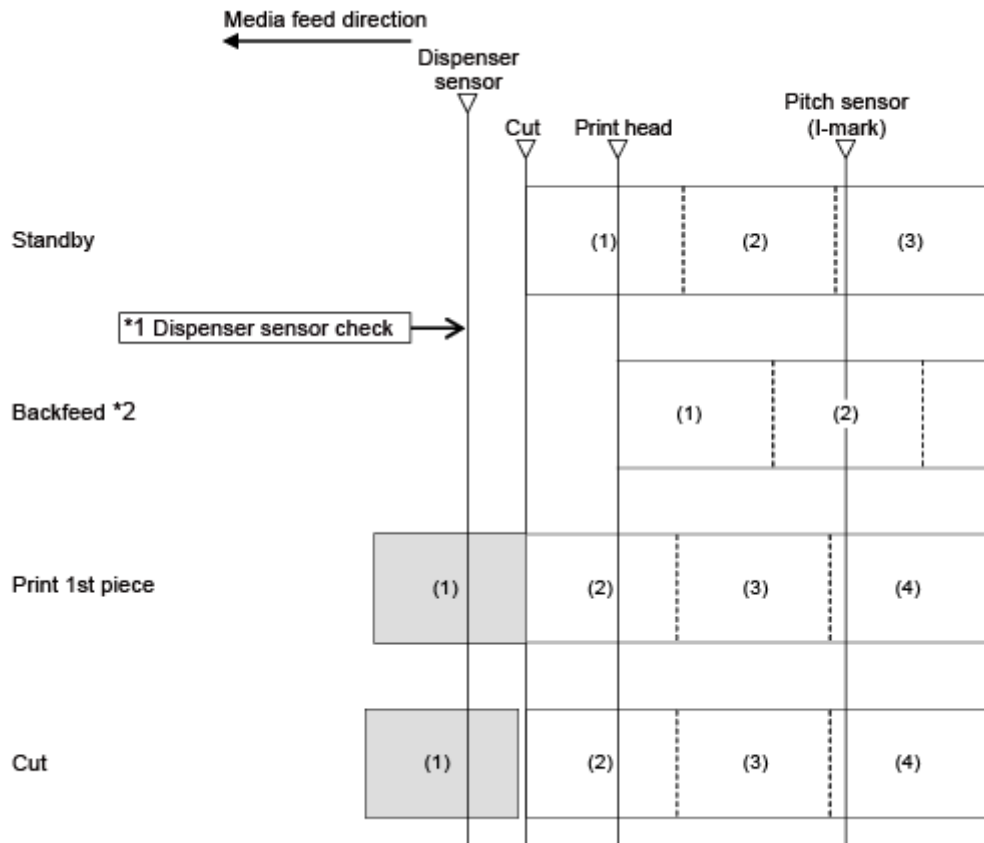

*1 The dispenser sensor confirms the dispensing condition and the product does not perform the next operation until the label is dispensed.

*2 The backfeed speed becomes 2 inches/sec immediately after powering on the product, immediately after backing from the sleep mode, or after 60 minutes or more from the last printing.



- The figure above shows the reference position when the I-mark sensor is used.

Timing Chart

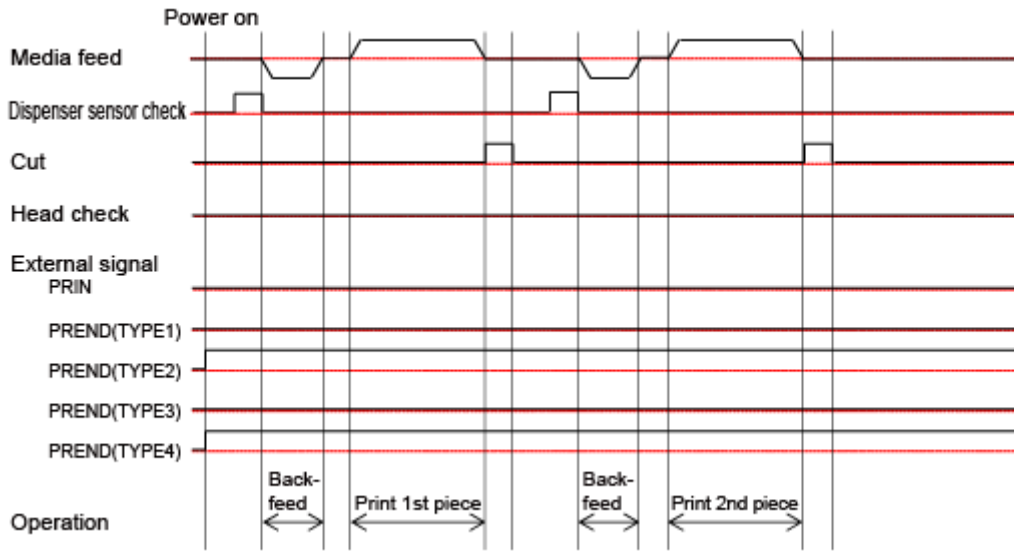

Linerless Mode, Backfeed Before Printing, and Without Pulse Input (Head Check Enabled) (CL4NX Plus Only)

Operation

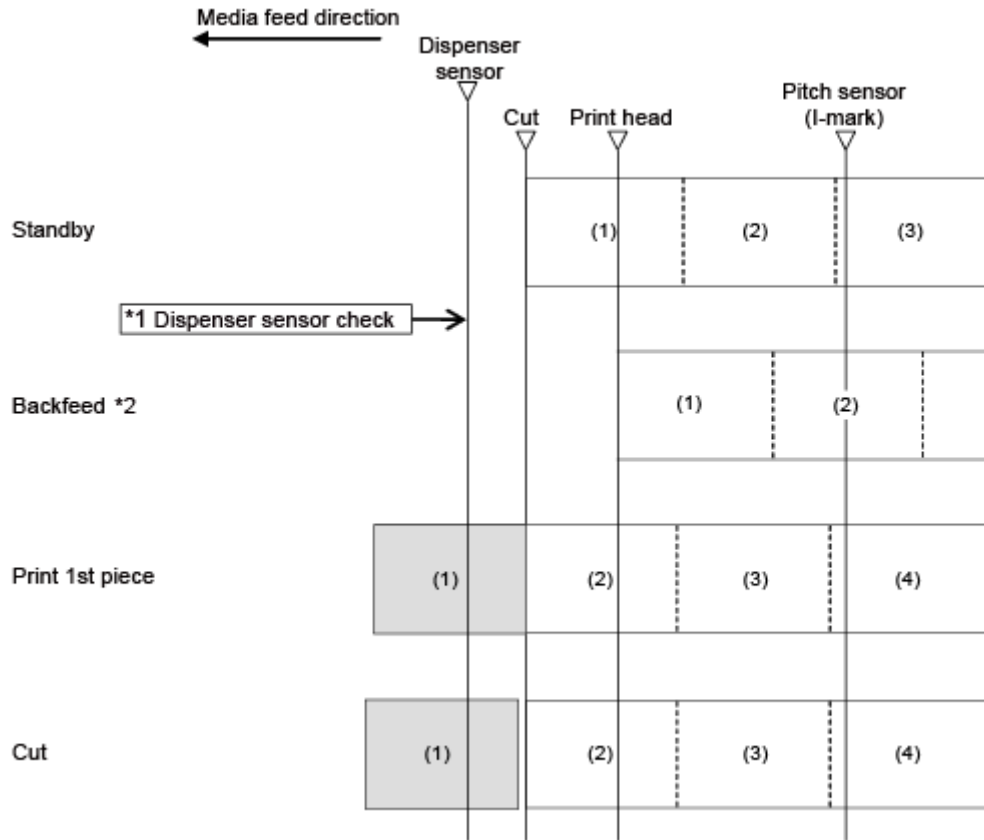

*1 The dispenser sensor confirms the dispensing condition and the product does not perform the next operation until the label is dispensed.

*2 The backfeed speed becomes 2 inches/sec immediately after powering on the product, immediately after backing from the sleep mode, or after 60 minutes or more from the last printing.



- The figure above shows the reference position when the I-mark sensor is used.

Timing Chart

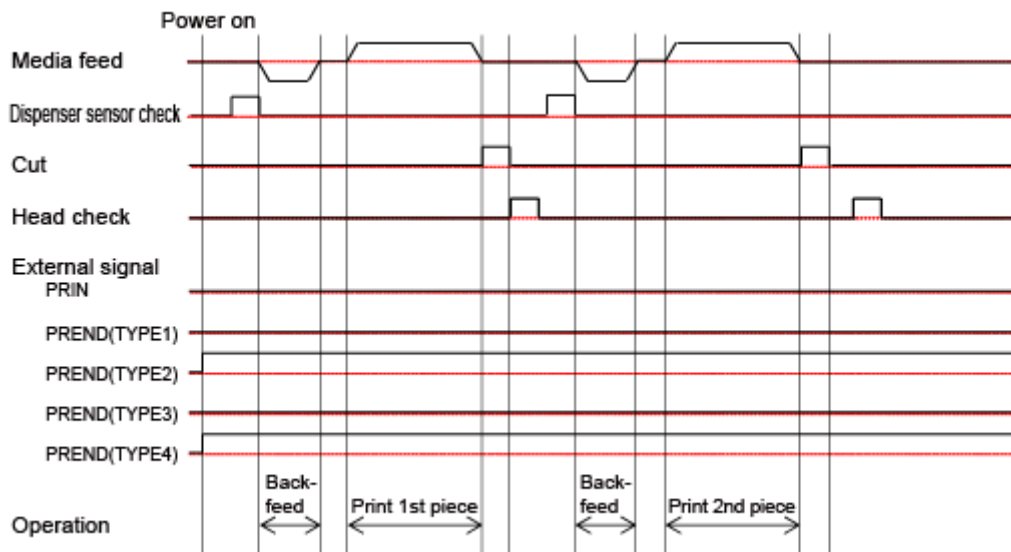

Linerless Mode, Backfeed Before Printing, and with Pulse Input (Head Check Disabled) (CL4NX Plus Only)

Operation

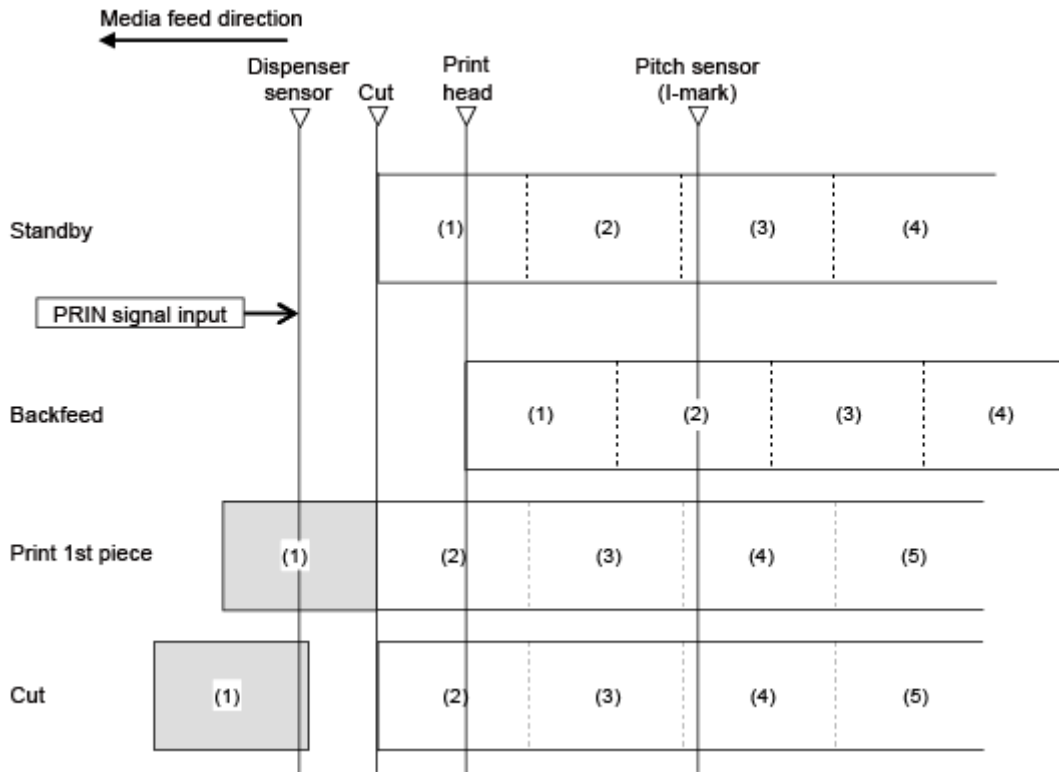

- The figure above shows the reference position when the I-mark sensor is used.

Timing Chart

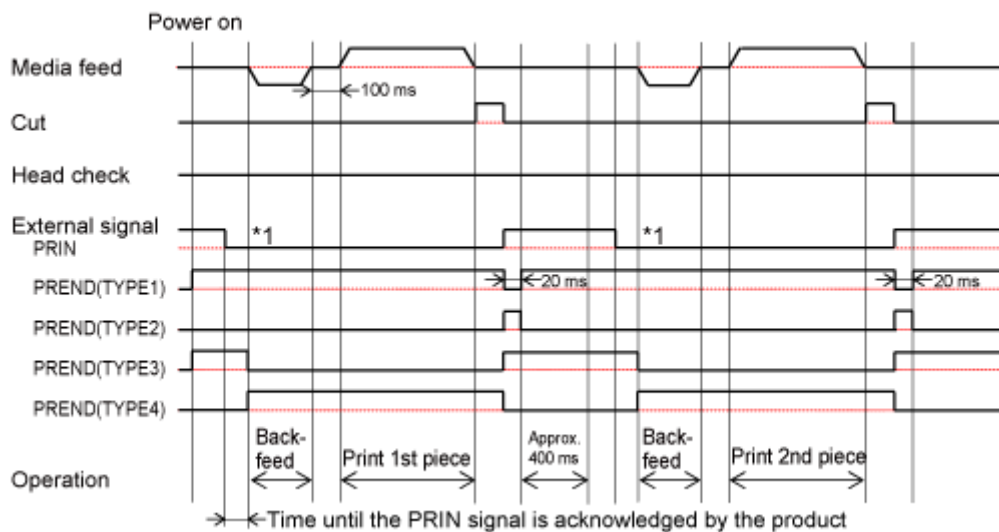

*1 Keep the PRIN signal until the PREND signal is outputted.

Linerless Mode, Backfeed Before Printing, and with Pulse Input (Head Check Enabled) (CL4NX Plus Only)

Operation

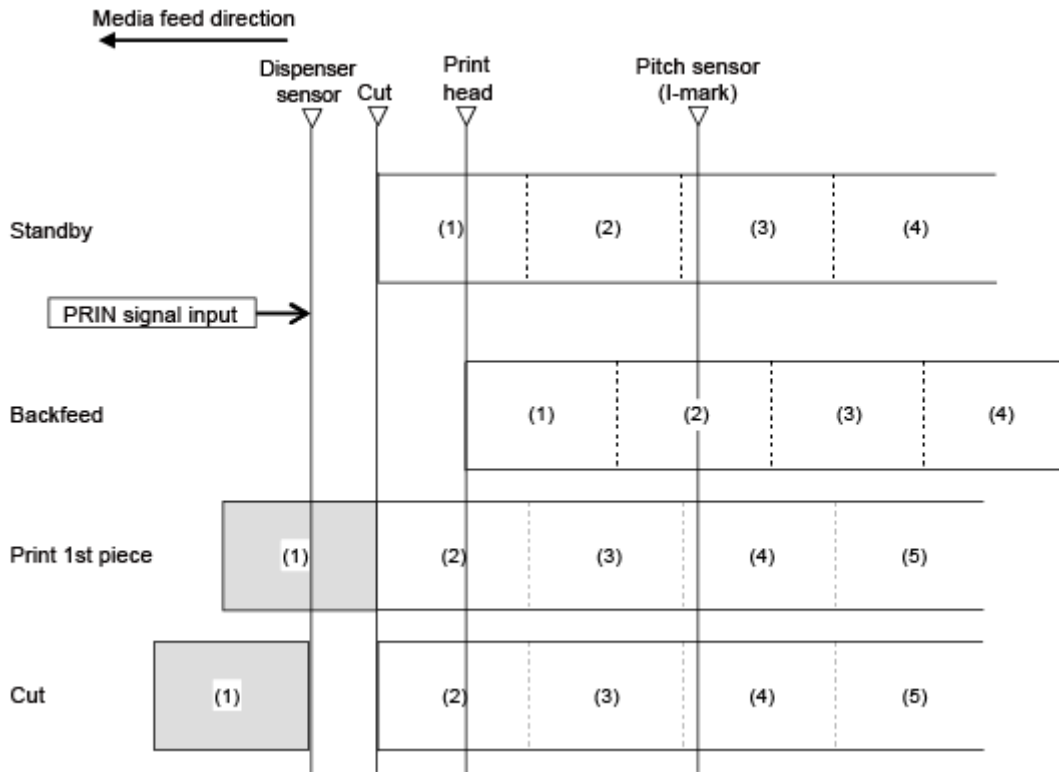

- The figure above shows the reference position when the I-mark sensor is used.

Timing Chart

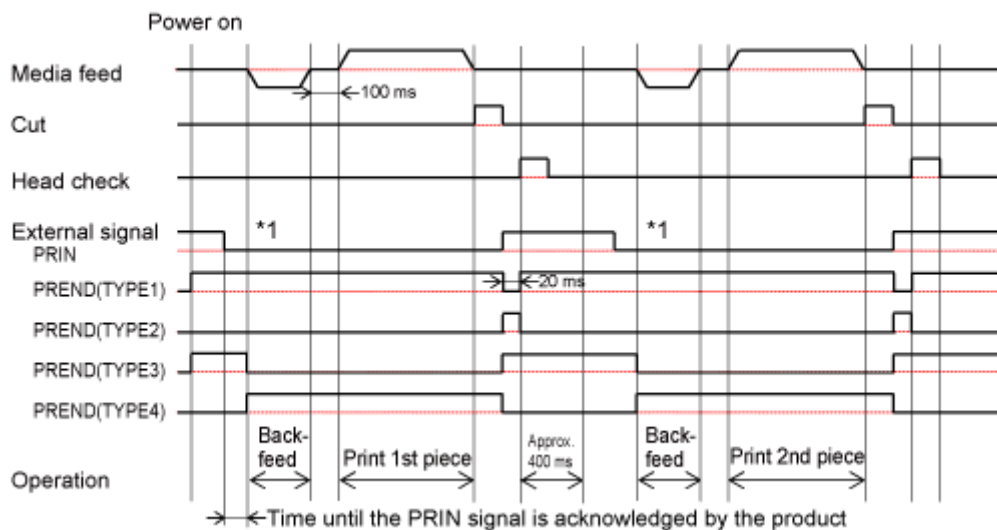

- *1 Keep the PRIN signal until the PREND signal is outputted.

Operations for RFID Write (RFID Models Only)

RFID Write with Continuous Mode (Tag Offset = 0)

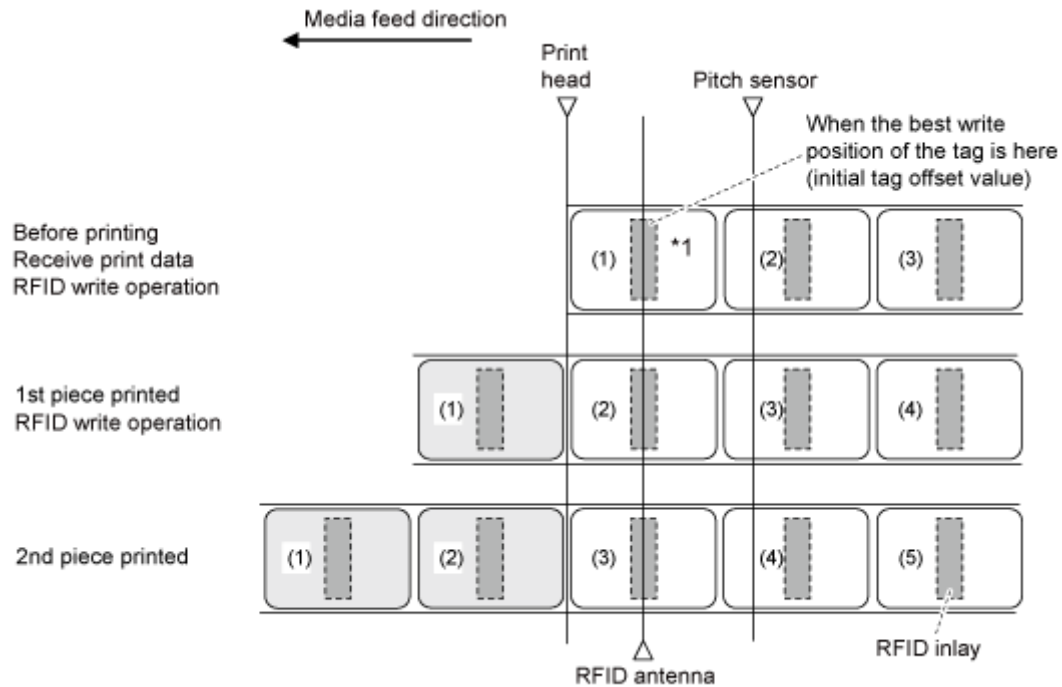

*1 The EPC code write <IP0> and RFID write <RK> commands write the data at this inlay position. The EPC code read, RFID read [DC2]PJ, UID/EPC/IDm print <TU>, and UID/EPC/IDm return <RU> commands acquire the information at this inlay position.

RFID Write with Continuous Mode (Tag Offset > 0)

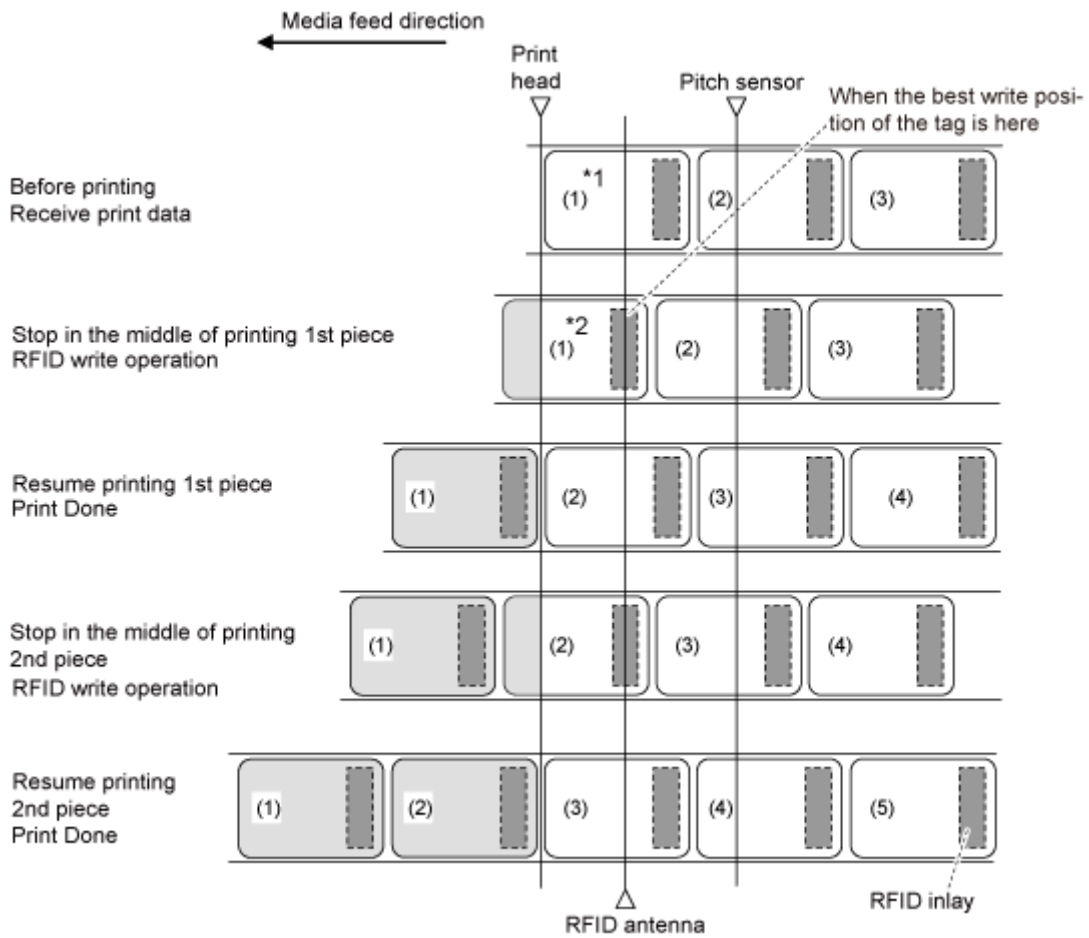

*1 Because the EPC code read, RFID read [DC2]PJ and UID/EPC/IDm print <TU> commands acquire the information at this inlay position, do not use them.

*2 The EPC code write <IP0> and RFID write <RK> commands write the data at this inlay position. The EPC code read and UID/EPC/IDm return <RU> commands acquire the information at this inlay position.

RFID Write with Continuous Mode (Tag Offset < 0)

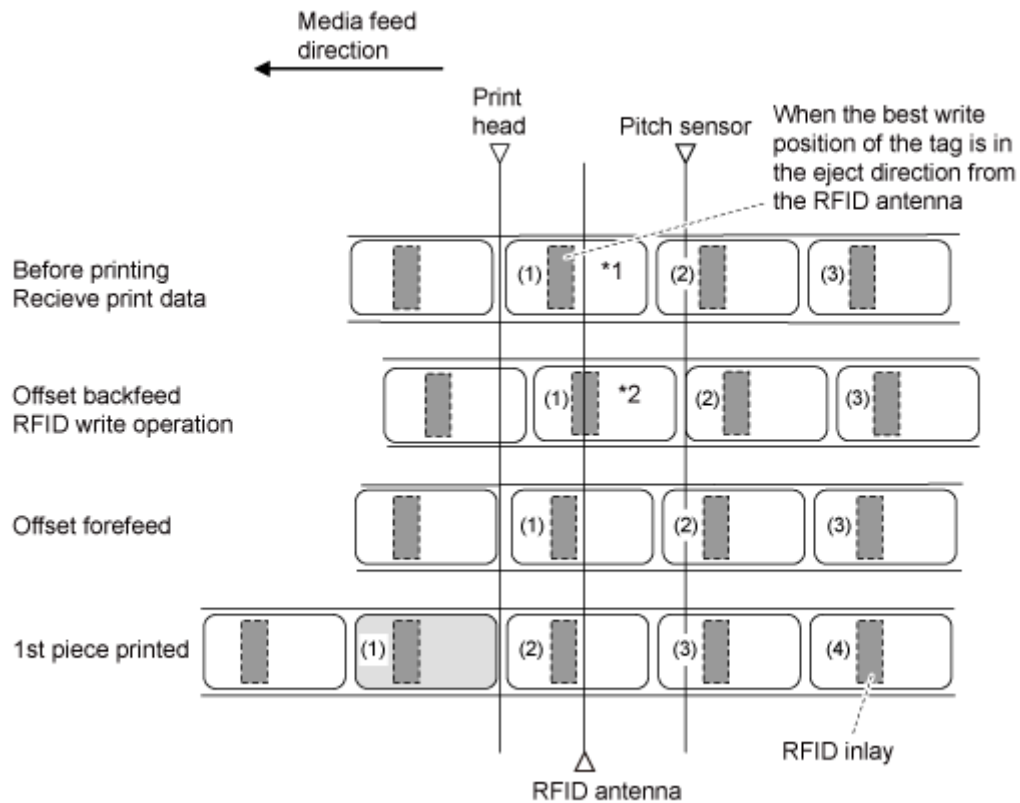

*1 Because the EPC code read and RFID read [DC2]PJ commands acquire the information at this inlay position, do not use them.

*2 The EPC code write <IP0> and RFID write <RK> commands write the data at this inlay position. The EPC code read, UID/EPC/IDm print <TU>, and UID/EPC/IDm return <RU> commands acquire the information at this inlay position.



- When the media position is not fixed, such as when the print head is unlocked with paper replacement, feed one piece of the label and perform the minus offset operation.

RFID Write with Tear-Off Mode (Tag Offset = 0)

When the tear-off mode is selected, the tag backfeeds before printing and stops at the manual cut position after printing.

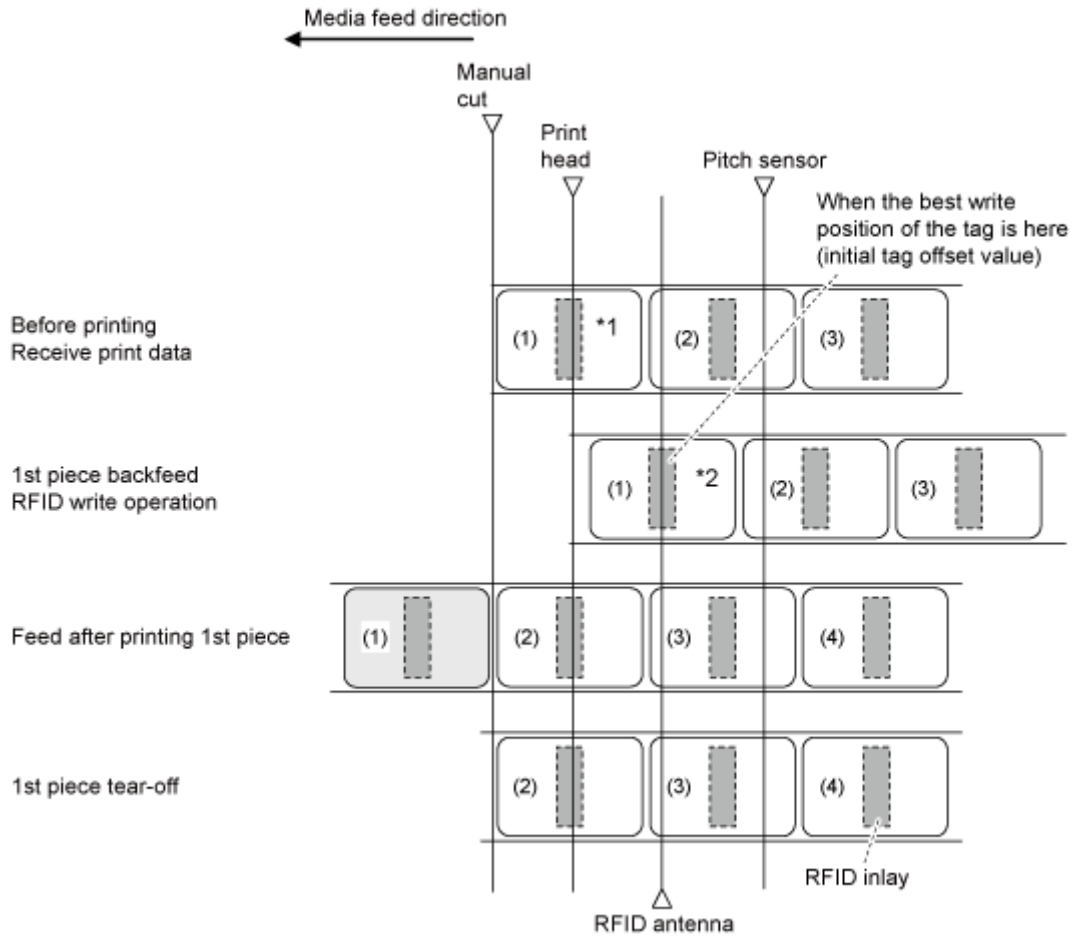

*1 Because the EPC code read and RFID read [DC2]PJ commands acquire the information at this inlay position, do not use them.

*2 The EPC code write <IP0> and RFID write <RK> commands write the data at this inlay position. The EPC code read, UID/EPC/IDm print <TU> and UID/EPC/IDm return <RU> commands acquire the information at this inlay position.

RFID Write with Tear-Off Mode (Tag Offset > 0)

When the tear-off mode is selected, the tag backfeeds before printing and stops at the manual cut position after printing.

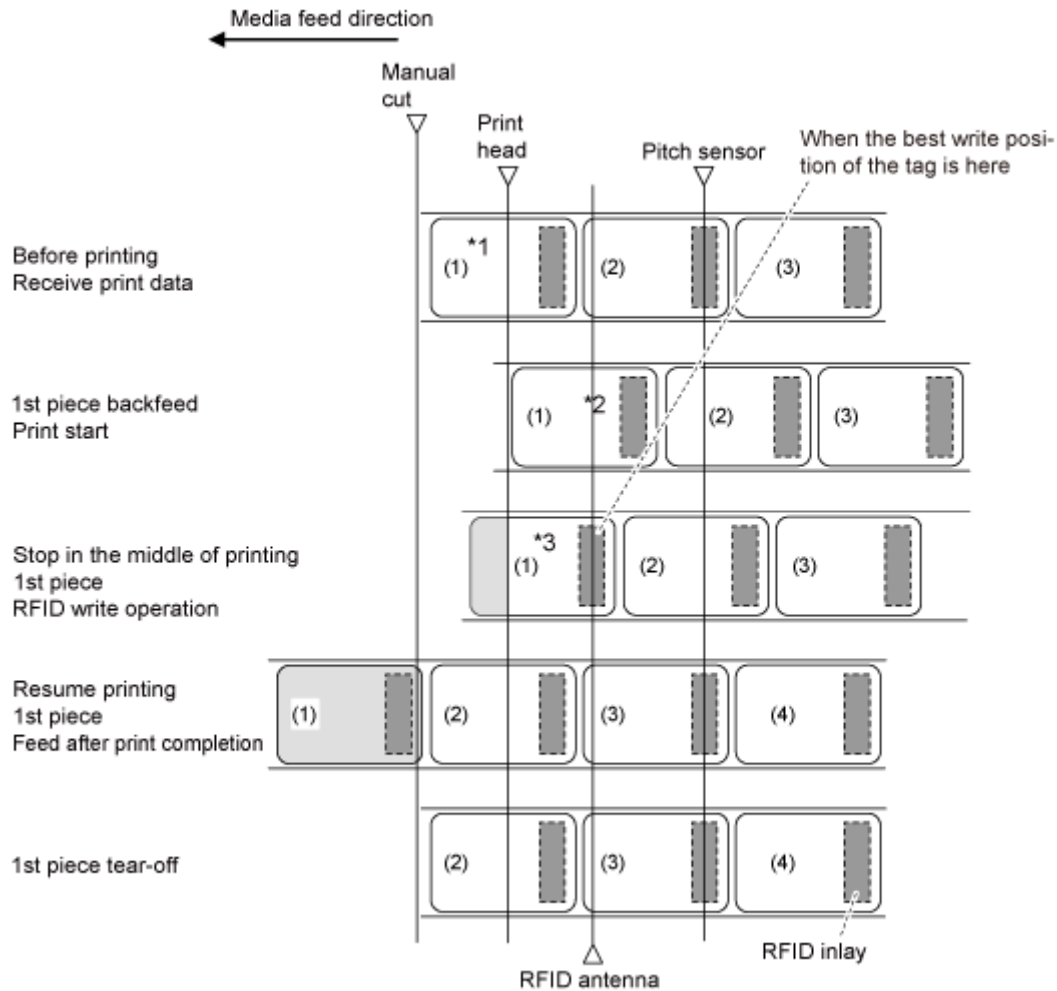

*1 Because the EPC code read and RFID read [DC2]PJ commands acquire the information at this inlay position, do not use them.

*2 Because the EPC code read and UID/EPC/IDm print <TU> commands acquire the information at this inlay position, do not use them if the Tag Offset is set to other than initial value.

*3 The EPC code write <IP0> and RFID write <RK> commands write the data at this inlay position. The EPC code read and UID/EPC/IDm return <RU> commands acquire the information at this inlay position.

RFID Write with Cutter Mode and Backfeed After Printing (Tag Offset = 0)

When the cutter mode with backfeed after printing is selected, the tag backfeeds after the cut and stops at the print head position.

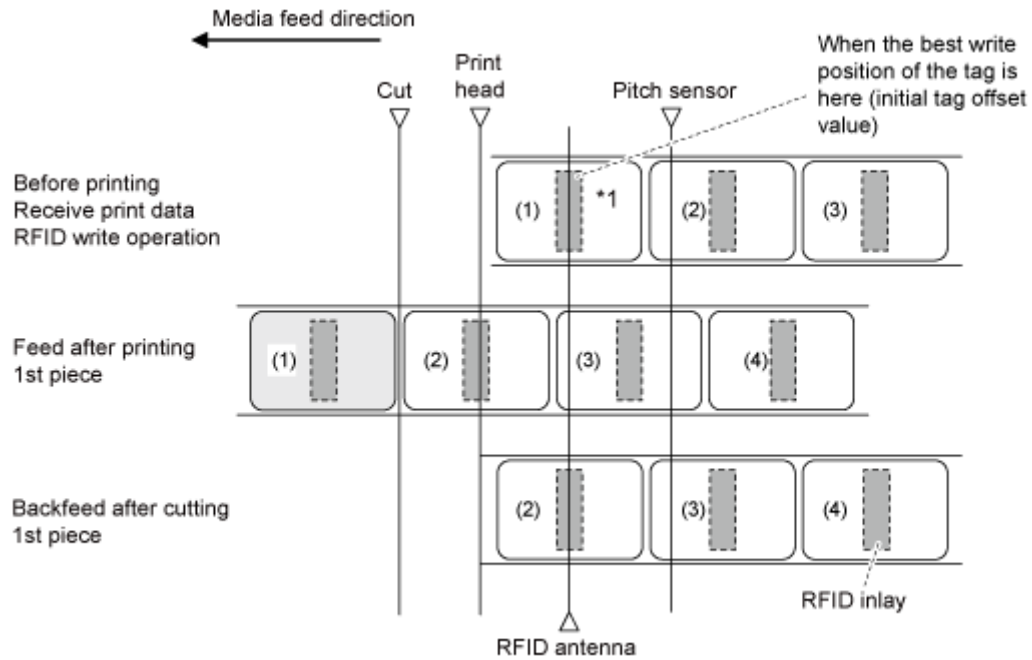

*1 The EPC code write <IP0> and RFID write <RK> commands write the data at this inlay position. The EPC code read, RFID read [DC2]PJ, UID/EPC/IDm print <TU>, and UID/EPC/IDm return <RU> commands acquire the information at this inlay position.

RFID Write with Cutter Mode and Backfeed After Printing (Tag Offset > 0)

When cutter mode with backfeed after printing is selected, the tag backfeeds after the cut and stops at the print head position.

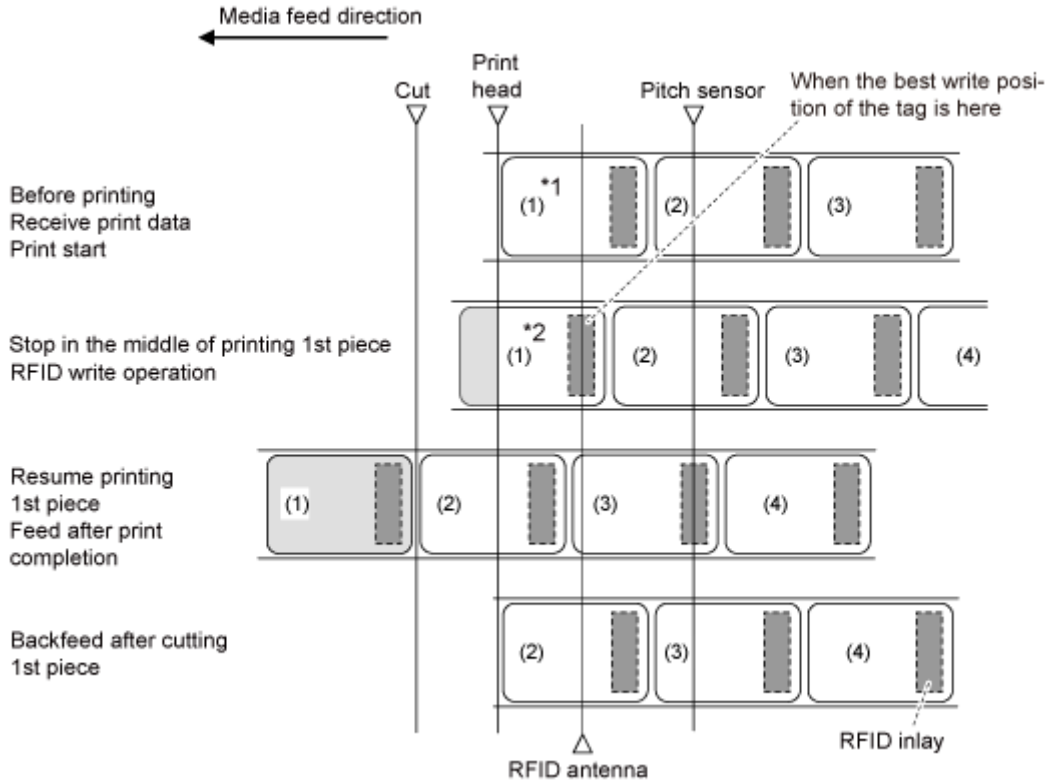

*1 Because the EPC code read, RFID read [DC2]PJ and UID/EPC/IDm print <TU> commands acquire the information at this inlay position, do not use them if the Tag Offset is set to other than an initial value.

*2 The EPC code write <IP0> and RFID write <RK> commands write the data at this inlay position. The EPC code read and UID/EPC/IDm return <RU> commands acquire the information at this inlay position.

RFID Write with Cutter Mode and Backfeed Before Printing (Tag Offset = 0)

When cutter mode with backfeed before printing is selected, the tag backfeeds before printing, and stops at the cut position after printing.

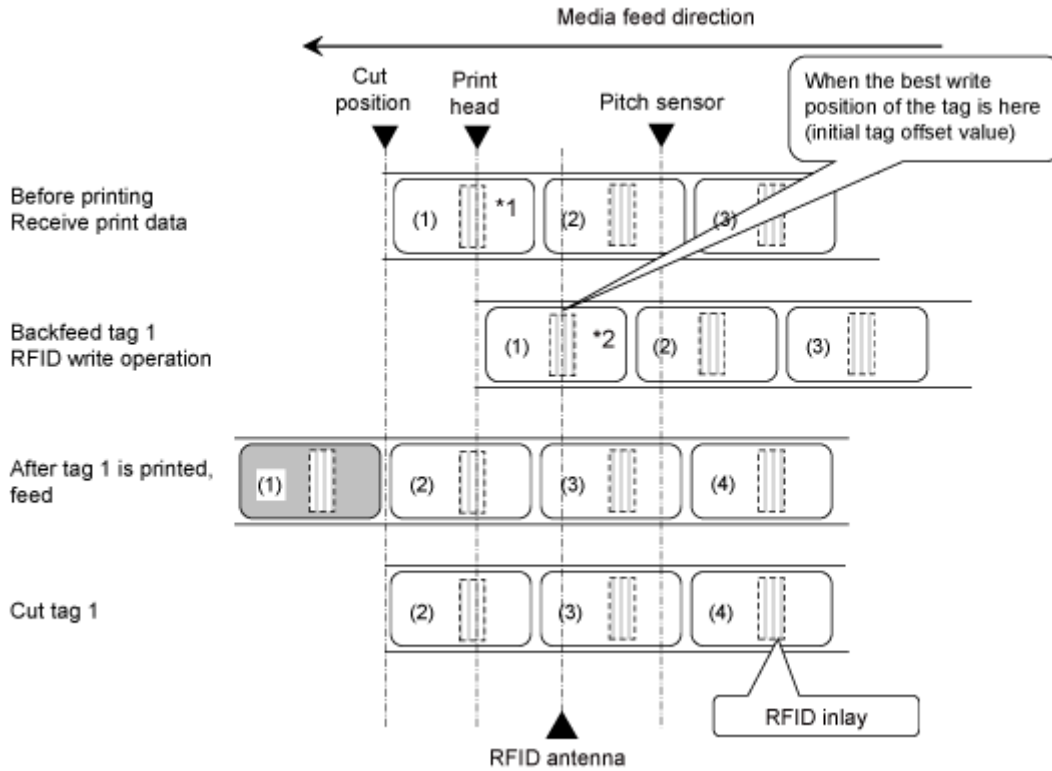

*1 Because the EPC code read and RFID read [DC2]PJ commands acquire the information at this inlay position, do not use them.

*2 The EPC code write <IP0> and RFID write <RK> commands write the data at this inlay position. The EPC code read, UID/EPC/IDm print <TU>, and UID/EPC/IDm return <RU> commands acquire the information at this inlay position.

RFID Write with Cutter Mode and Backfeed Before Printing (Tag Offset > 0)

When cutter mode with backfeed before printing is selected, the tag backfeeds before printing, and stops at the cut position after printing.

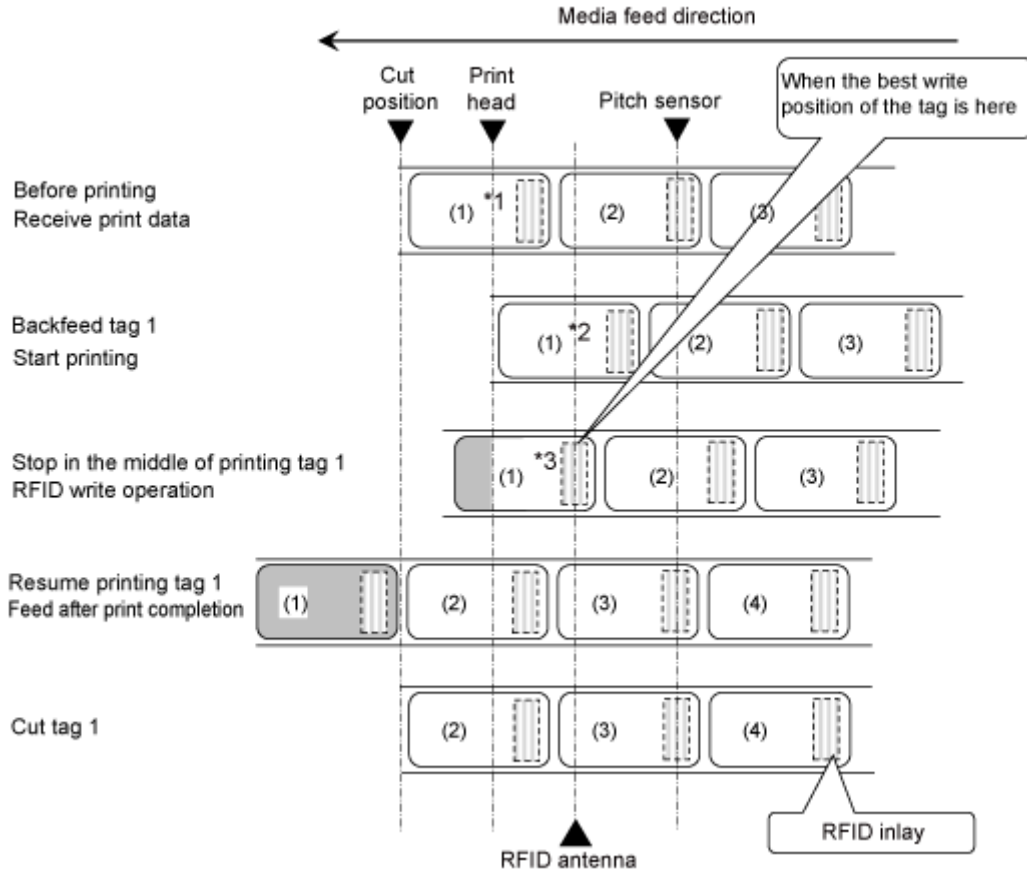

*1 Because the EPC code read and RFID read [DC2]PJ commands acquire the information at this inlay position, do not use them.

*2 Because the EPC code read and UID/EPC/IDm print <TU> commands acquire the information at this inlay position, do not use them if the Tag Offset is set to other than an initial value.

*3 The EPC code write <IP0> and RFID write <RK> commands write the data at this inlay position. The EPC code read, and UID/EPC/IDm return <RU> commands acquire the information at this inlay position.

RFID Write with Cut & Print Mode

When the cut & print mode is selected, RFID encoding is performed before printing while stopping at the print head position.

RFID tag offset cannot be used in the cut & print mode. The setting value will be ignored even if tag offset is set.

Also, the RFID tag error print in the cut & print mode is the same as the error print in the continuous or cutter mode.

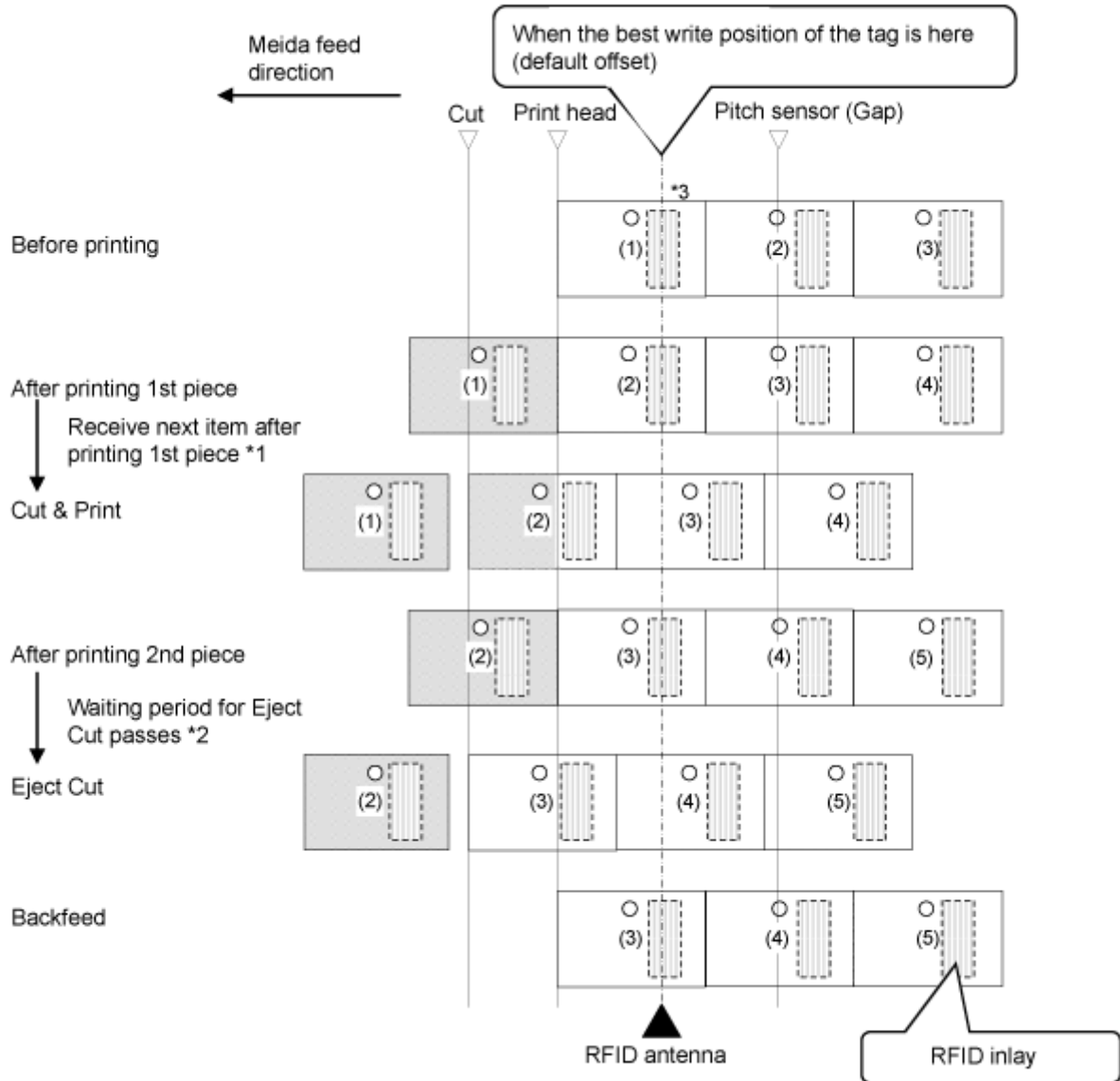

*1 After printing, if the next data is received, printing will be done and the media will be cut on the cut position.

*2 After printing, if the next data is not received and the waiting period for Eject Cut has passed, Eject Cut will be performed.

*3 The EPC code write <IP0> command writes the data at this inlay position. The RFID read [DC2]PJ, printing tag data <TU>, and EPC/TID return <RU> commands acquire the information at this inlay position.



- The figure above shows the operation when the Gap sensor is used and the reference position is adjusted with <#> on side hole tags.
-

Error Printing Sample

RFID tag error print in the cut & print mode



Be careful of white streaks.

RFID Write with Dispenser Mode and Backfeed After Printing (Tag Offset = 0)

When dispenser mode with backfeed after printing is selected, the tag backfeeds after the tag is removed and stops at the print head position.

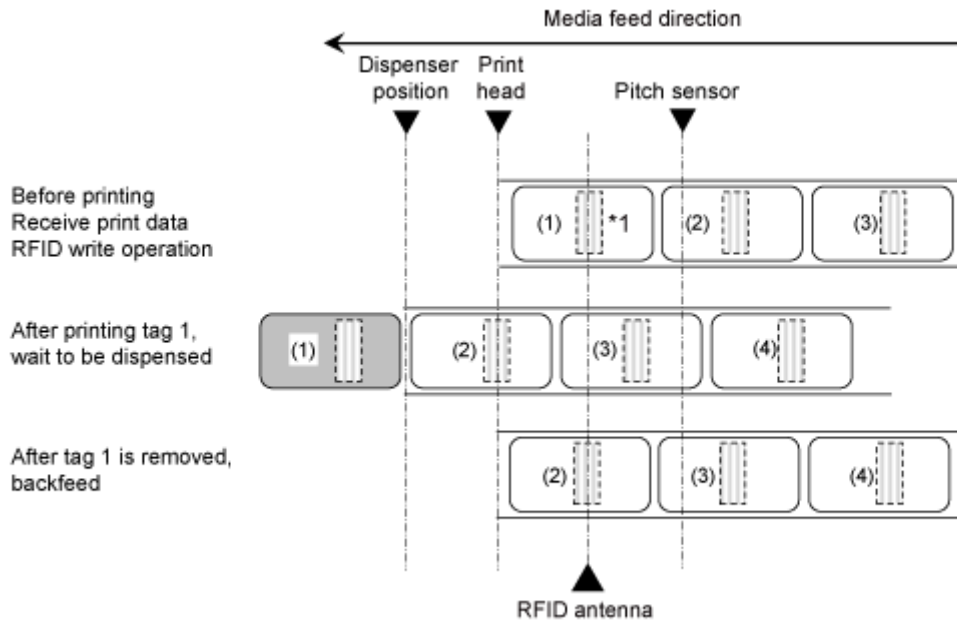

*1 The EPC code write <IP0> and RFID write <RK> commands write the data at this inlay position. The EPC code read, RFID read [DC2]PJ, UID/EPC/IDm print <TU>, and UID/EPC/IDm return <RU> commands acquire the information at this inlay position.

RFID Write with Dispenser Mode and Backfeed After Printing (Tag Offset > 0)

When dispenser mode with backfeed after printing is selected, the tag backfeeds after dispensing and the tag is removed, and stops at the print head position, and then the next item is analyzed and printing is executed.

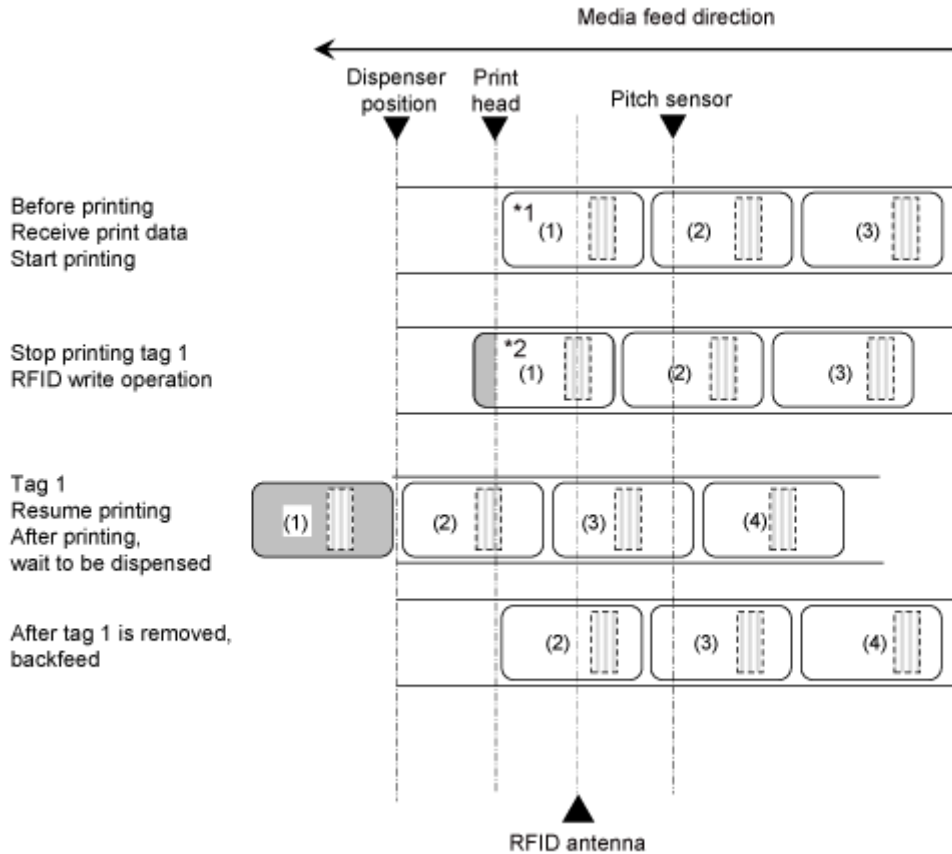

*1 Because the EPC code read, RFID read [DC2]PJ, UID/EPC/IDm print <TU>, and UID/EPC/IDm return <RU> commands acquire the information at this inlay position, do not use them if the Tag Offset is set to other than an initial value.

*2 The EPC code write <IP0> and RFID write <RK> commands write the data at this inlay position. The EPC code read, and UID/EPC/IDm return <RU> commands acquire the information at this inlay position.

RFID Write with Dispenser Mode and Backfeed Before Printing (Tag Offset = 0)

When dispenser mode with backfeed before printing is selected, the tag backfeeds before printing, and stops at the dispensing position after printing.

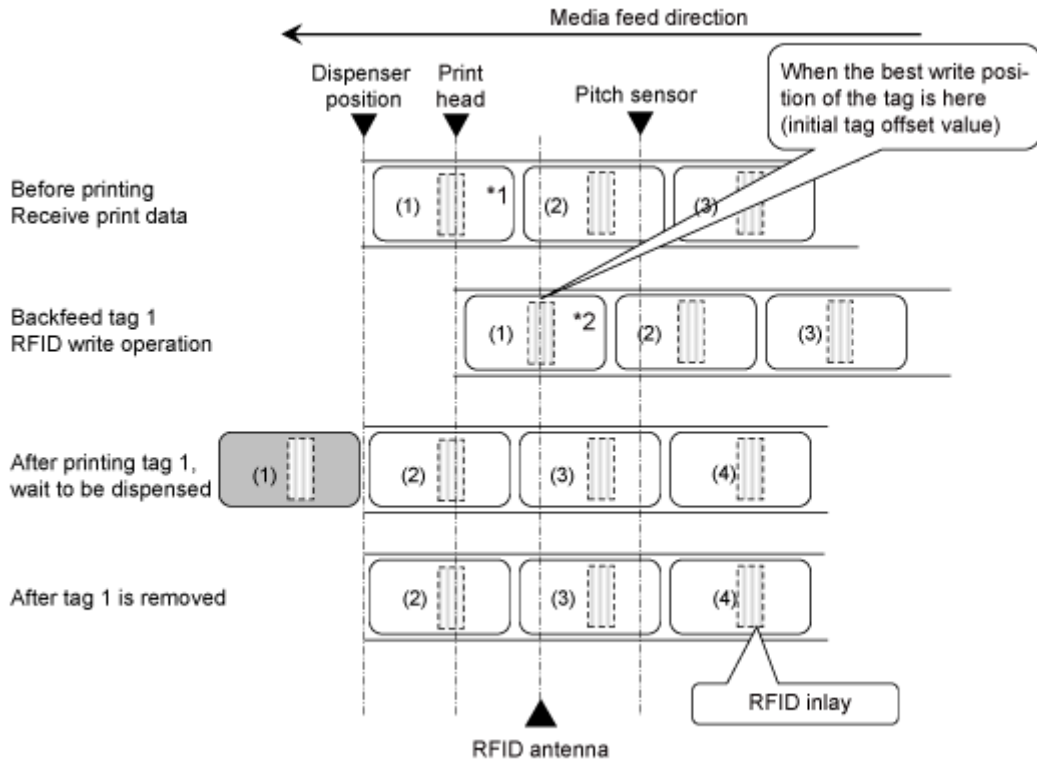

*1 Because the EPC code read and RFID read [DC2]PJ commands acquire the information at this inlay position, do not use them.

*2 The EPC code write <IP0> and RFID write <RK> commands write the data at this inlay position. The EPC code read, UID/EPC/IDm print <TU>, and UID/EPC/IDm return <RU> commands acquire the information at this inlay position.

RFID Write with Dispenser Mode and Backfeed Before Printing (Tag Offset > 0)

When dispenser mode with backfeed before printing is selected, the tag backfeeds before printing, and stops at the dispensing position after printing.

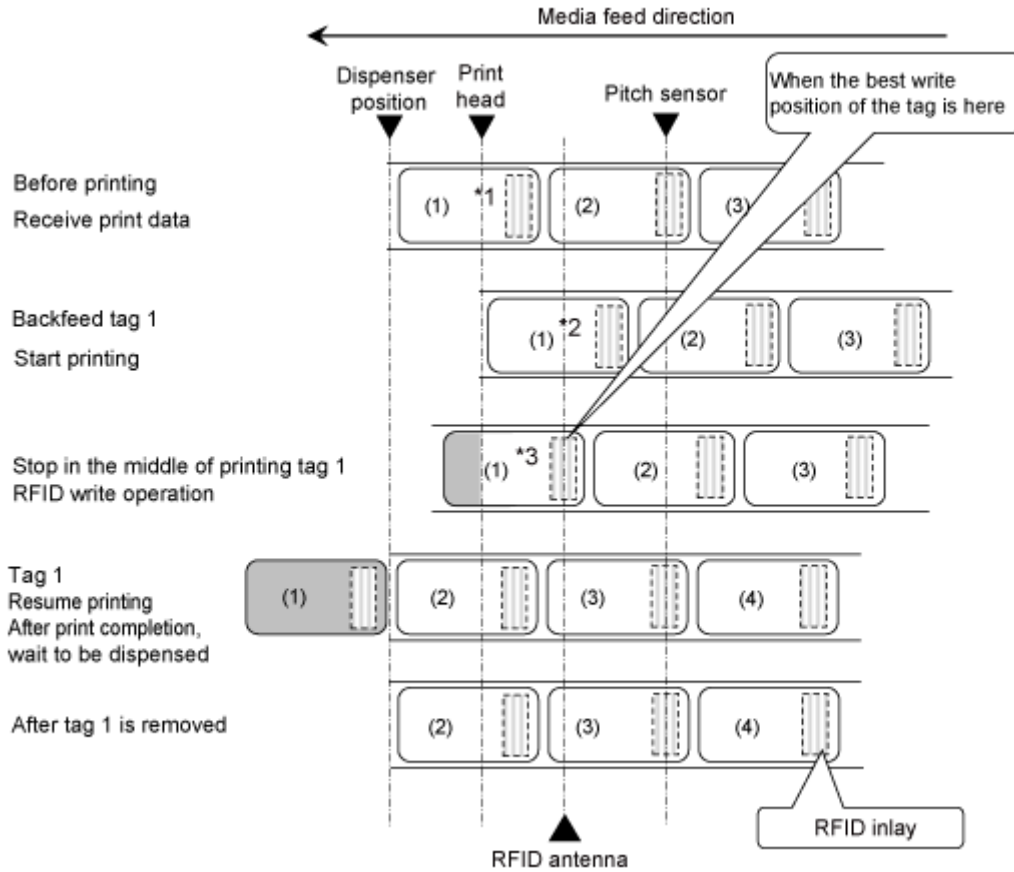

*1 Because the EPC code read and RFID read [DC2]PJ commands acquire the information at this inlay position, do not use them.

*2 Because the EPC code read and UID/EPC/IDm print <TU> commands acquire the information at this inlay position, do not use them if the Tag Offset is set to other than an initial value.

*3 The EPC code write <IP0> and RFID write <RK> commands write the data at this inlay position. The EPC code read, UID/EPC/IDm print <TU>, and UID/EPC/IDm return <RU> commands acquire the information at this inlay position.

Operations When the Barcode Check Function Is Enabled

Continuous Mode When the Barcode Check Function Is Enabled

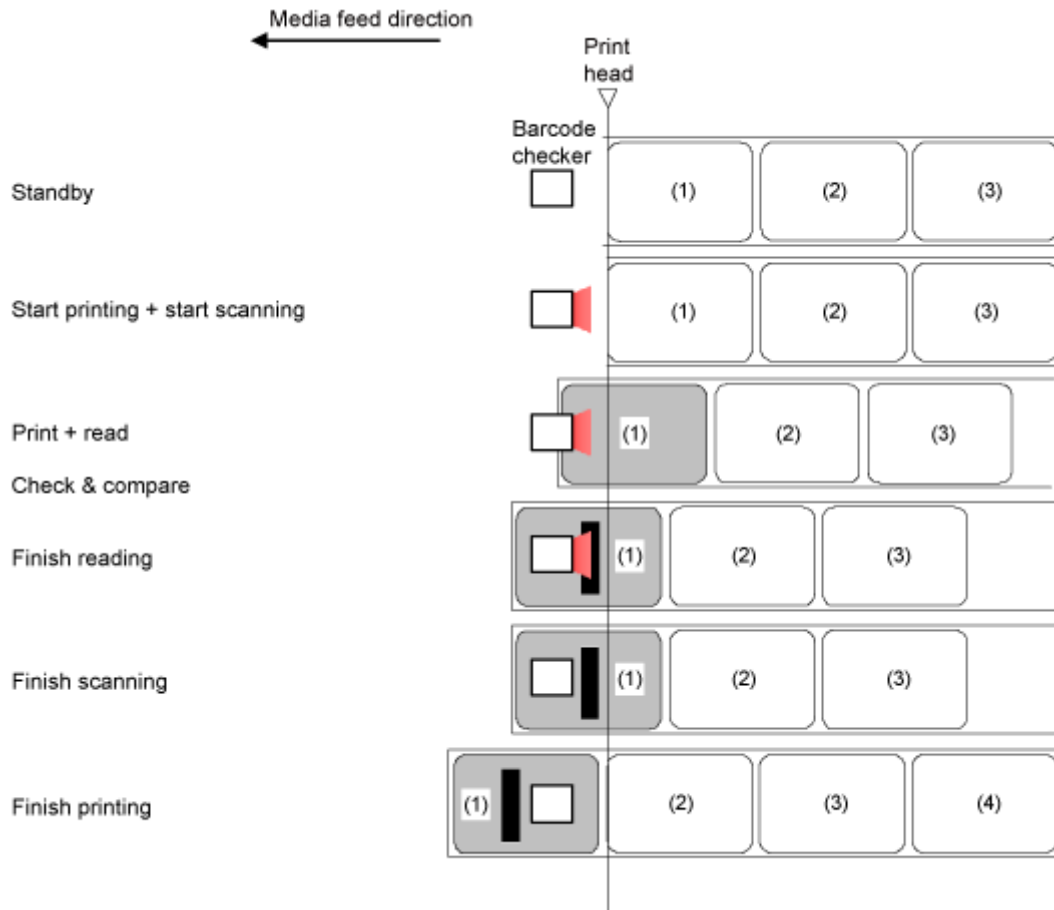

Cutter Mode (Cutting Every Label) When the Barcode Check Function Is Enabled

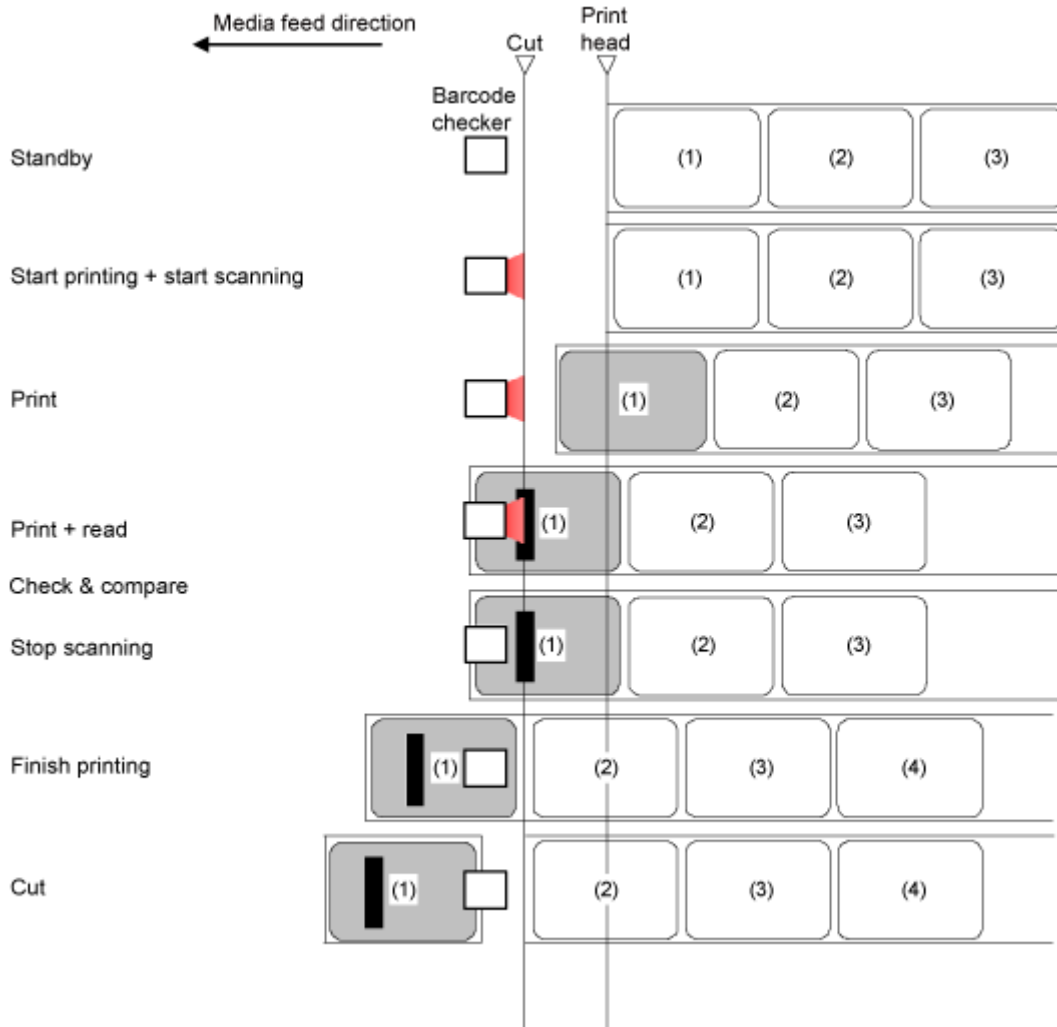

Cutter Mode (Cutting According to the Specified Number of Labels, No Cutting) When the Barcode Check Function Is Enabled

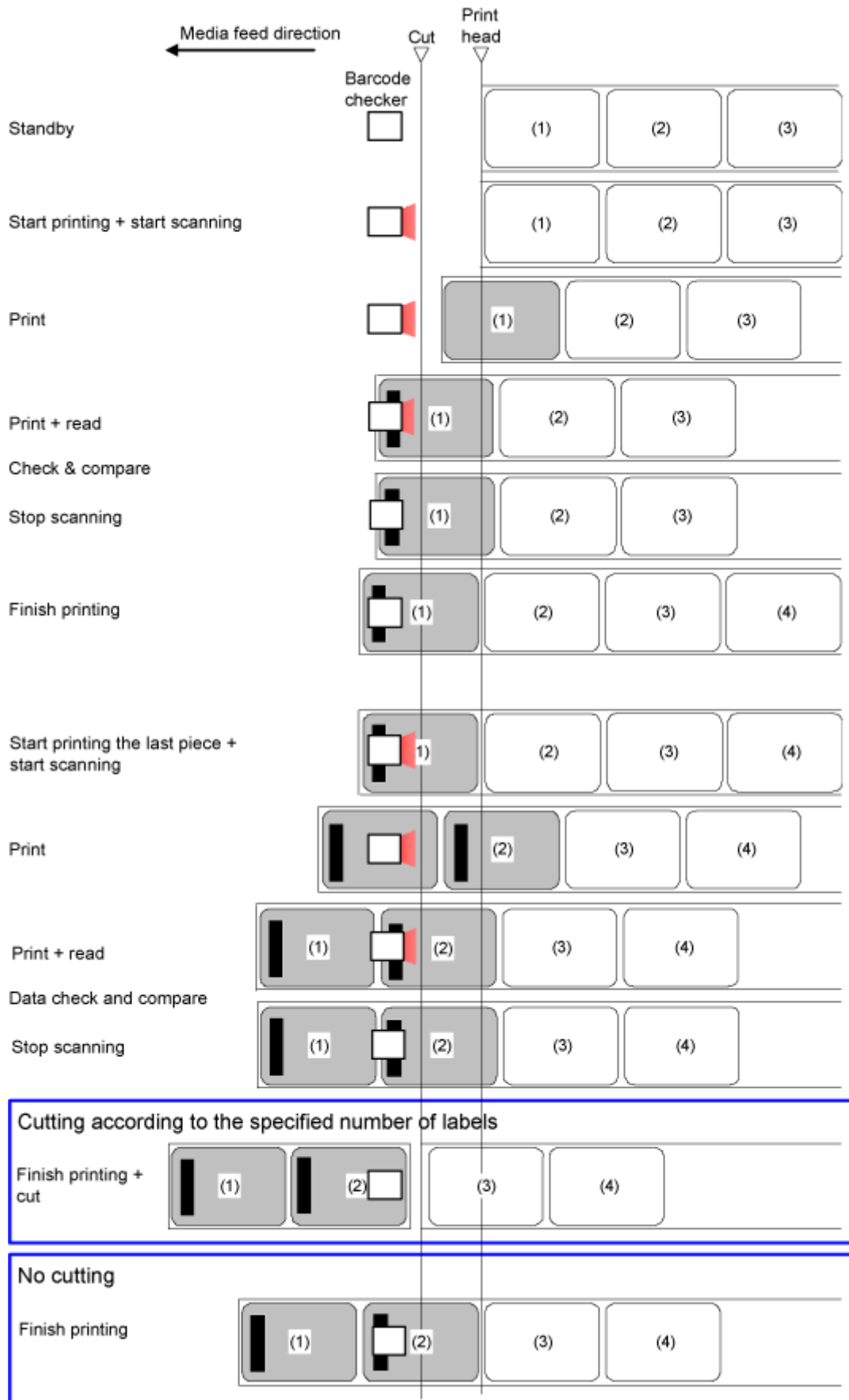

Cut & Print Mode When the Barcode Check Function Is Enabled

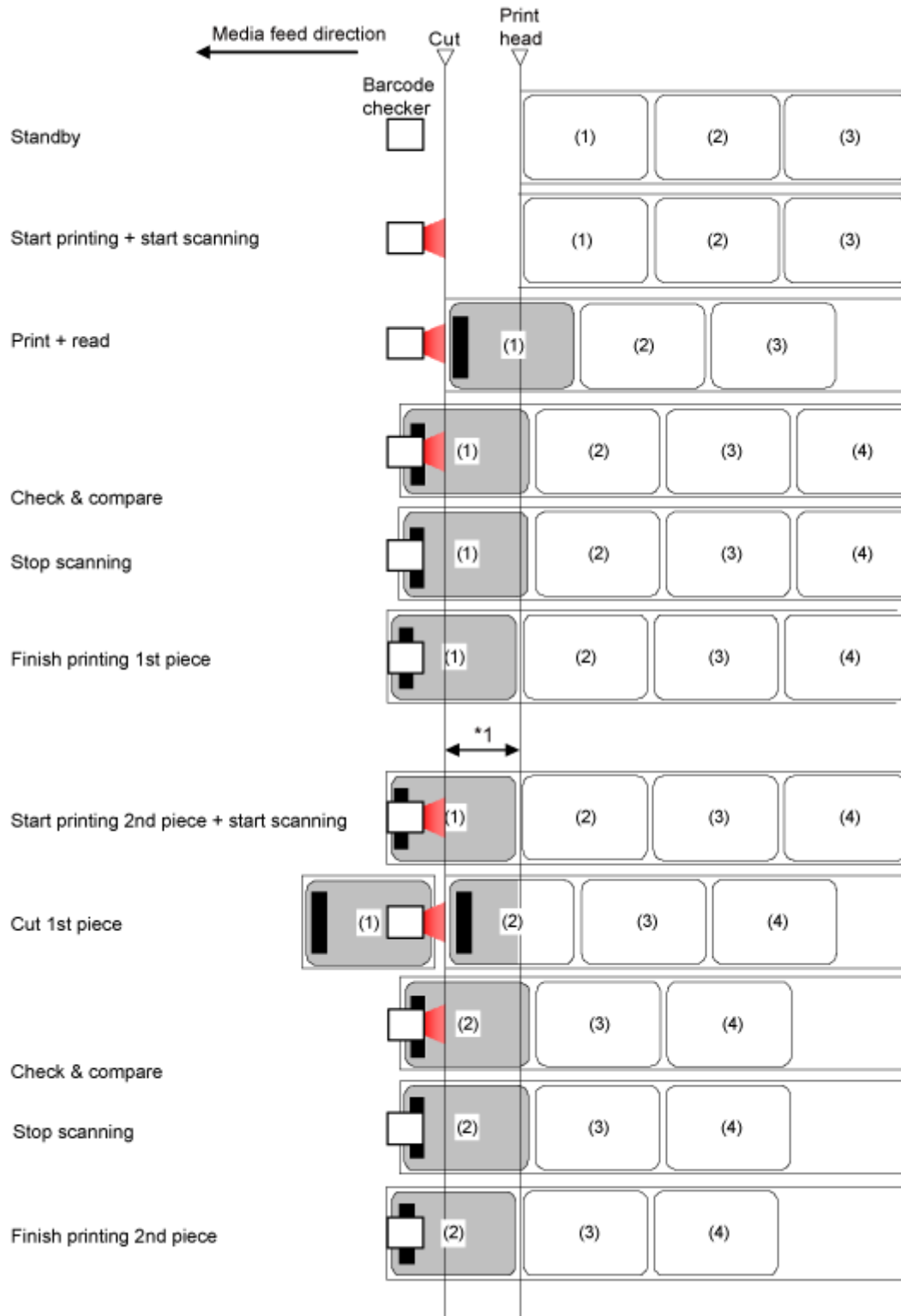

*1 Do not print barcodes/2D codes on the area between the print head and the cut position.

Dispenser Mode When the Barcode Check Function Is Enabled

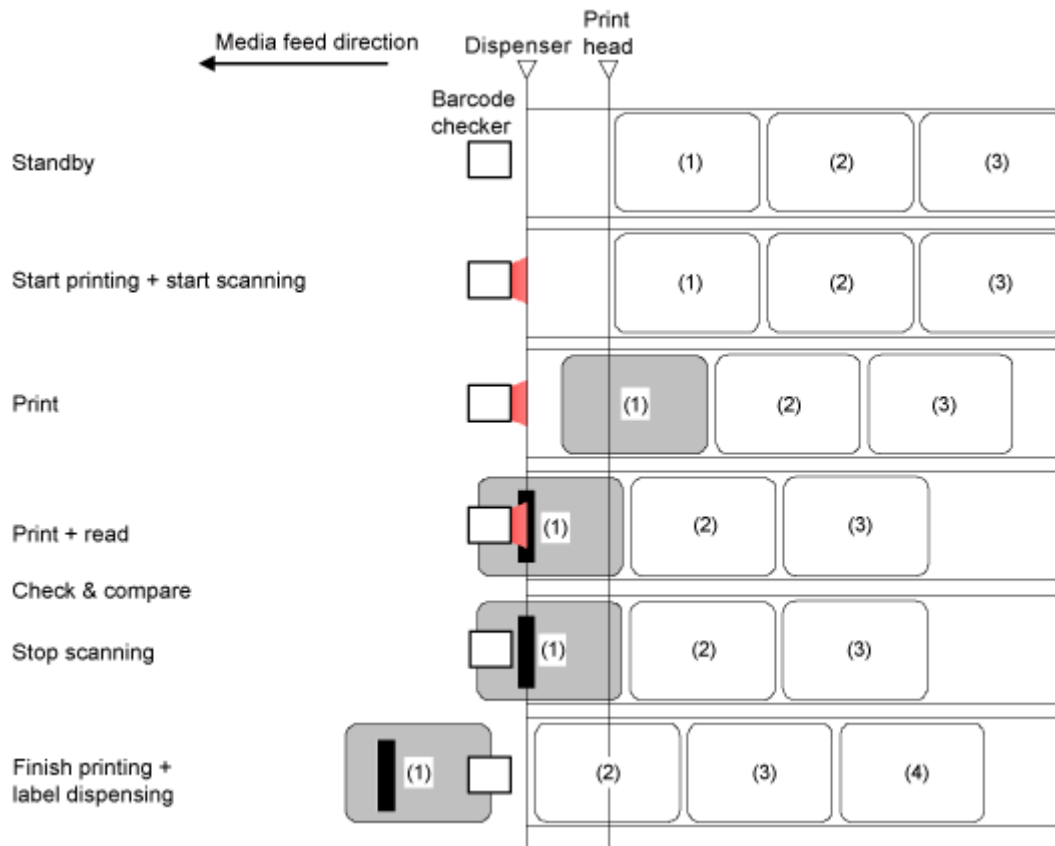

Operations When the Media Sensor Is Disabled

Media Sensor Disabled

When the media sensor is disabled, media stops at the specified print end line.

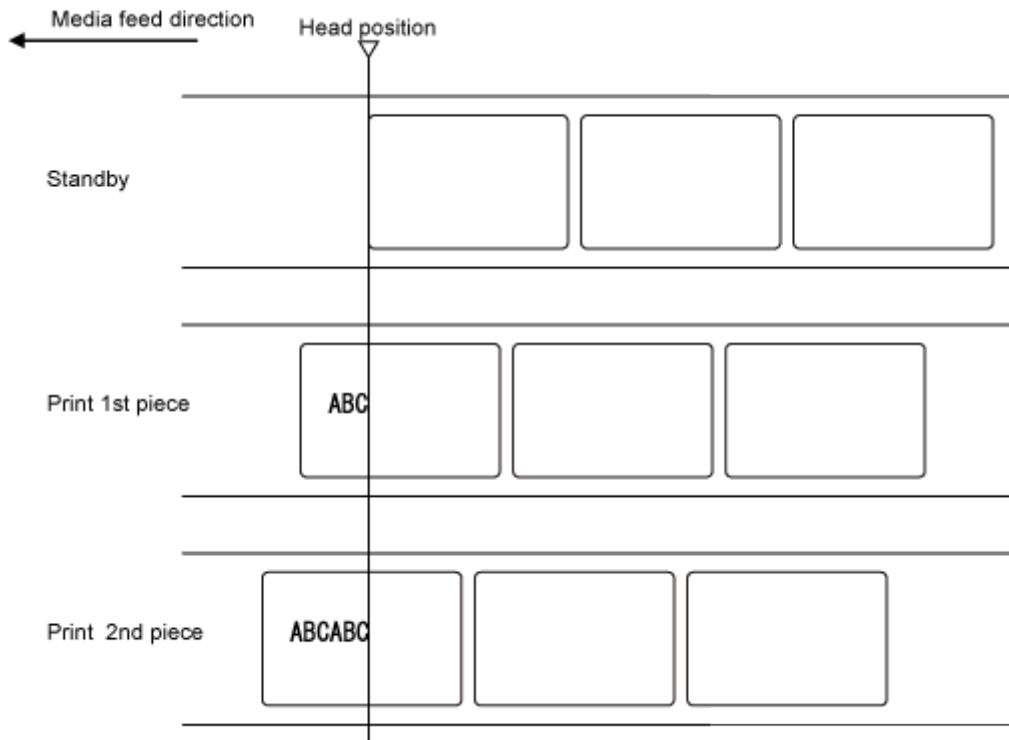

Adjusting the Base Reference Point

About the Base Reference Point

The base reference point is the point at which one determines the print position and stop/cut/ dispensing position.

The base reference point differs depending on the operation mode or media sensor you use.

Continuous Mode/Tear-off Mode

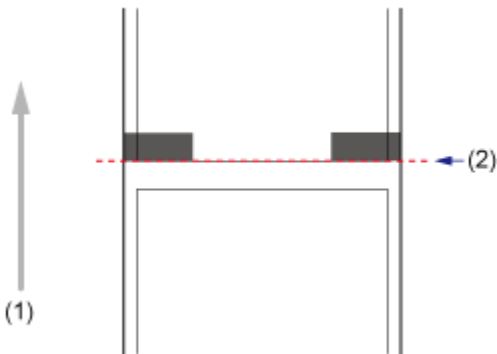
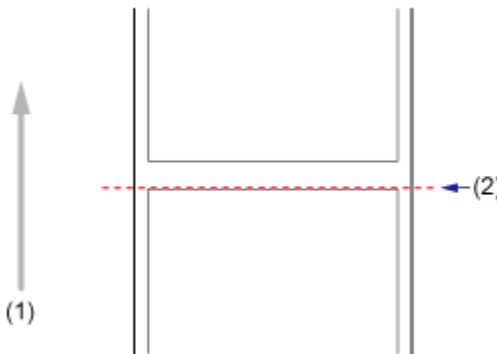
I-mark Label	Gap Label
 <p>(1) Feed direction (2) Print and stop position</p>	 <p>(1) Feed direction (2) Print and stop position</p>

Cutter Mode

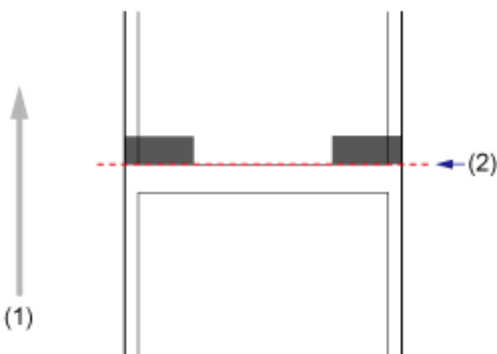
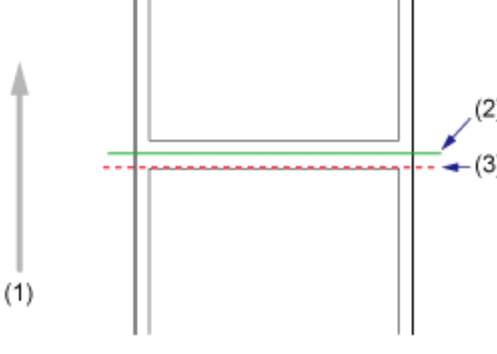
I-mark Label	Gap Label
 <p>(1) Feed direction (2) Print and cut position</p>	 <p>(1) Feed direction (2) Cut position (3) Print position</p>

Dispenser Mode

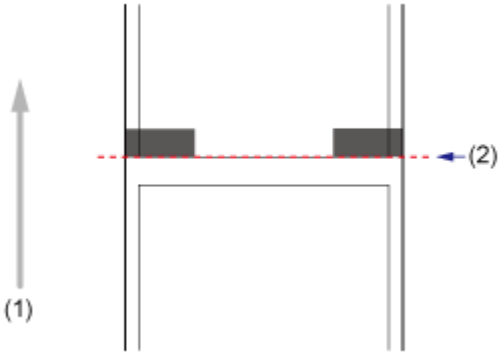
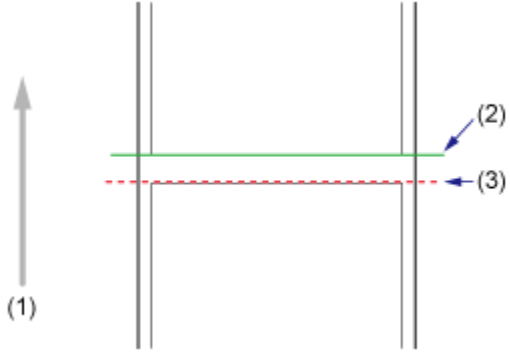
I-mark Label	Gap Label
 <p>The diagram shows a label being fed upwards between two vertical guides. A red dashed line indicates the print and dispensing position, with a blue arrow labeled (2) pointing to it. A grey arrow labeled (1) indicates the feed direction.</p> <p>(1) Feed direction (2) Print and dispensing position</p>	 <p>The diagram shows a label being fed upwards between two vertical guides. A green line indicates the dispensing position, with a blue arrow labeled (2) pointing to it. A red dashed line indicates the print position, with a blue arrow labeled (3) pointing to it. A grey arrow labeled (1) indicates the feed direction.</p> <p>(1) Feed direction (2) Dispensing position (3) Print position</p>

Linerless Mode (CL4NX Plus only)

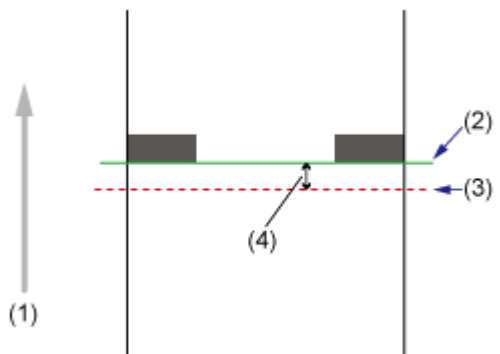
I-mark Linerless Label
 <p>The diagram shows a label being fed upwards between two vertical guides. A green line indicates the cut position, with a blue arrow labeled (2) pointing to it. A red dashed line indicates the print position, with a blue arrow labeled (3) pointing to it. A grey arrow labeled (1) indicates the feed direction. A double-headed arrow labeled (4) indicates a non-printable zone between the cut and print positions.</p> <p>(1) Feed direction (2) Cut position (3) Print position (4) Non-printable zone (5 mm / 0.2")</p>

Adjusting the Print Position

Set the [Pitch] in the [Printing] > [Advanced] > [Adjustments] menu to adjust the print position.

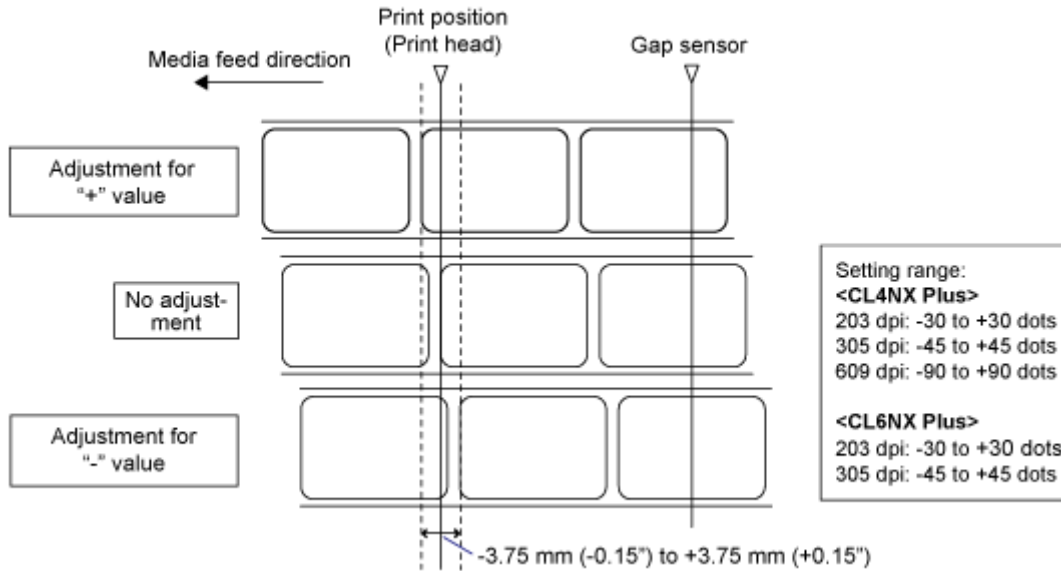

- The above reference position (print position) is the stop position when the media sensor type is set to Gap.

- When the product is in Online mode, press the  button on the operator panel to change to Offline mode.



- Press the  button to show the [Settings] menu.

3. Select [Printing] using the ◀/▶ buttons, and then press the ← button.

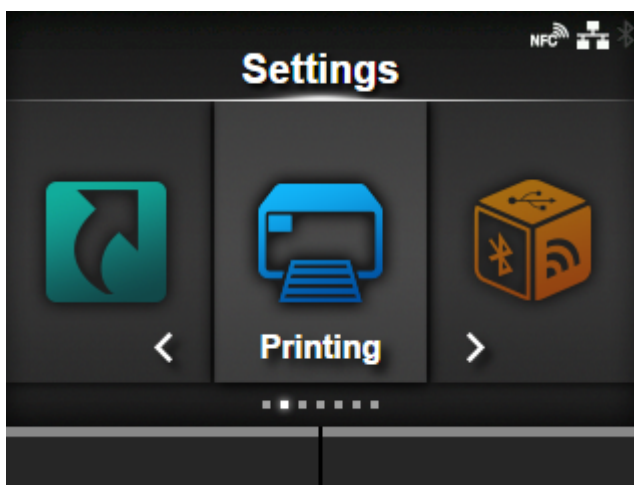

4. Select the [Advanced] > [Adjustments] > [Pitch] menu using the ▲/▼ buttons, and then press the ← button.

The [Pitch] screen appears.

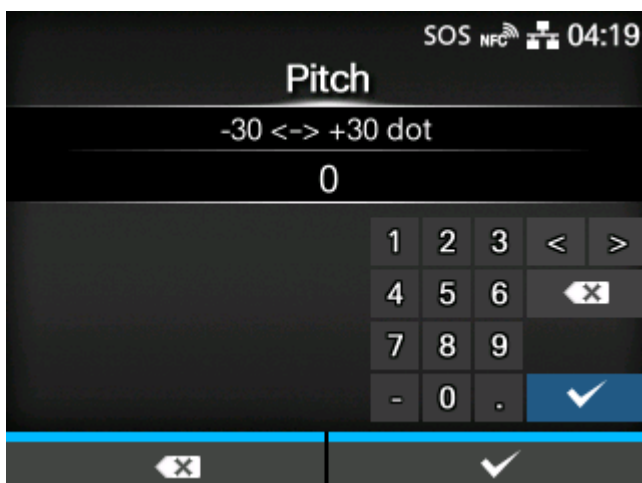



5. Change the setting value. Press the ◀/▶/▲/▼ buttons to select a number and then press the ← button to enter the number to the text box.

The setting range is as follows:

Resolution	CL4NX Plus	CL6NX Plus
203 dpi (1 dot = 0.125 mm (0.0049"))	-30 to +30 dots	-30 to +30 dots
305 dpi (1 dot = 0.083 mm (0.0033"))	-45 to +45 dots	-45 to +45 dots
609 dpi	-90 to +90 dots	-

Resolution	CL4NX Plus	CL6NX Plus
(1 dot = 0.042 mm (0.0017"))		

6. Press the  button to save the setting value.
7. Press the  button to change to Offline mode.
8. Press the  button again to change to Online mode.

You can print to check the adjusted print position.

Adjusting the Media Stop Position

Set the [Offset] in the [Printing] > [Advanced] > [Adjustments] menu to adjust the media stop position.

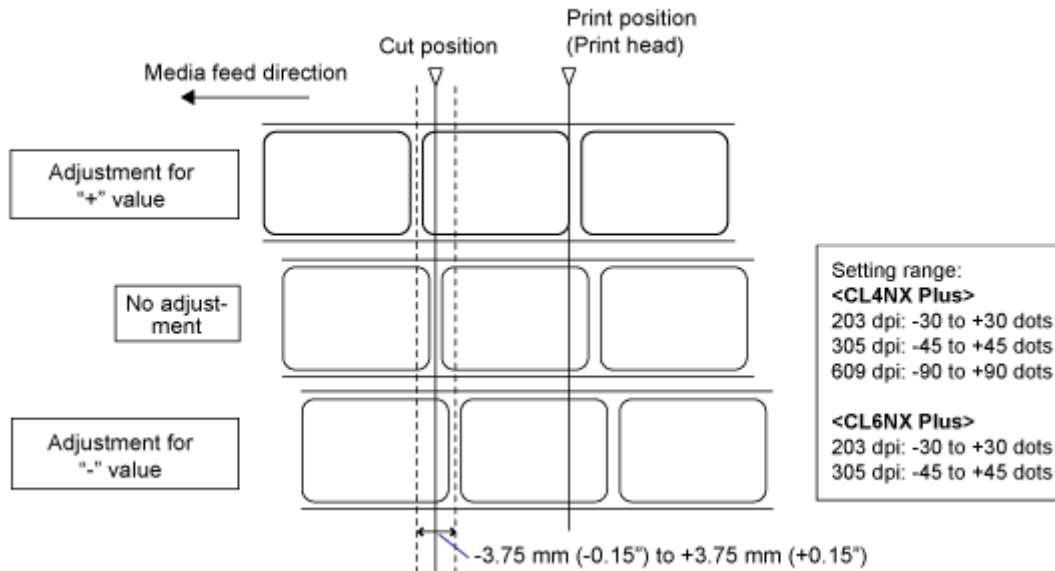

- The above cut reference position for printing indicates the stop position when the media sensor type is set to Gap.
- You can also adjust when the operation mode is specified to Tear-off or Dispenser.

1. When the product is in Online mode, press the  button on the operator panel to change to Offline mode.



2. Press the  button to show the [Settings] menu.

3. Select [Printing] using the ◀/▶ buttons, and then press the ← button.

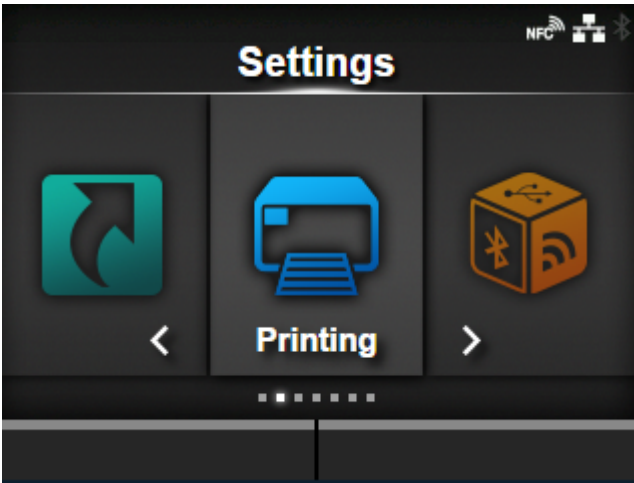

4. Select the [Advanced] > [Adjustments] > [Offset] menu using the ▲/▼ buttons, and then press the ← button.

The [Offset] screen appears.

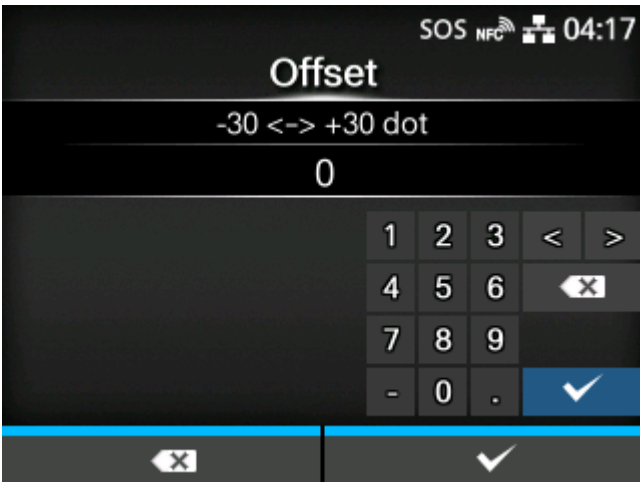



5. Change the setting value. Press the ◀/▶/▲/▼ buttons to select a number and then press the ← button to enter the number to the text box.

The setting range is as follows:

Resolution	CL4NX Plus	CL6NX Plus
203 dpi (1 dot = 0.125 mm (0.0049"))	-30 to +30 dots	-30 to +30 dots
305 dpi (1 dot = 0.083 mm (0.0033"))	-45 to +45 dots	-45 to +45 dots
609 dpi	-90 to +90 dots	-

Resolution	CL4NX Plus	CL6NX Plus
(1 dot = 0.042 mm (0.0017"))		

6. Press the  button to save the setting value.
7. Press the  button to change to Offline mode.
8. Press the  button again to change to Online mode.

You can print to check the adjusted stop position.

Notes on the Stop/Cut Position of Different Media

Stop Position of the Label in Dispenser Mode

The regular position is to let the label stay about 2 ± 1 mm ($0.08'' \pm 0.04''$) on the liner.

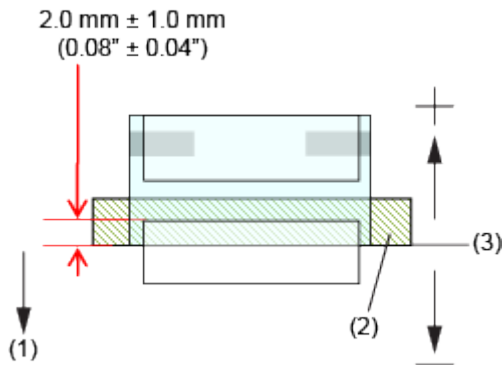

- (1) Feed direction
- (2) Dispenser bar
- (3) Stop position

Cut Position When Using the Label in Tear-Off/Cutter Modes

The regular cut position is between labels (only cut on the liner).

When you cut the label, the glue adheres to the blade of the cutter and the blade will decrease the performance of the cutter. Adjust the cut position so as not to cut the label.

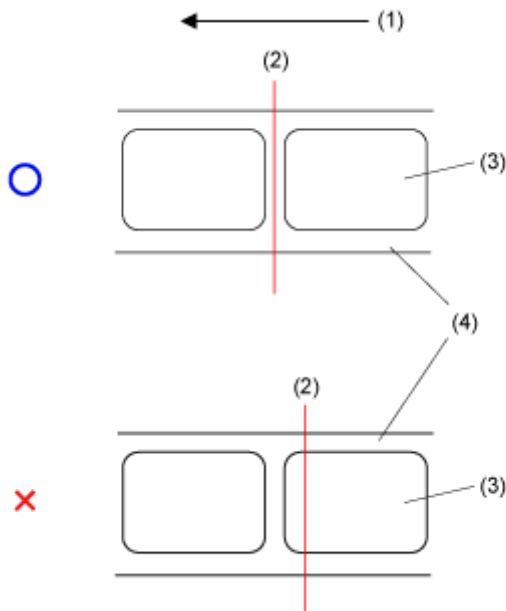

- (1) Feed direction
- (2) Cut position (I-mark sensor/Gap sensor)
- (3) Label

(4) Liner

Cut Position When Using the Media with Perforated Line in Tear-Off/Cutter Modes

For media with perforated lines, adjust the cut position so as not to cut the media on the perforated line or before the perforated line.

When the media is cut on the area not to be cut, it could cause a paper jam or damage.

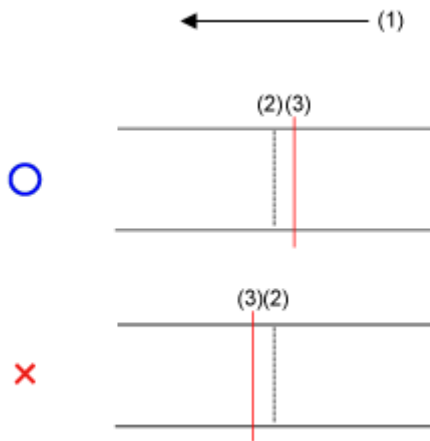

(1) Feed direction

(2) Perforated line

(3) Cut position

Adjusting the Print Quality

Adjusting the Print Darkness

The adjustment procedure for the print darkness is as follows:



- You can fine tune the print darkness by setting the [Darkness Adjust] in the [Printing] > [Advanced] > [Adjustments] menu.
- When the [Printing] > [Advanced] > [Prioritize] menu has been set to [Commands] and the print darkness is specified by command, the data will be printed with the print darkness specified by the command.
- While the print job is paused, the [Adjustments] menu will appear instead of the [Settings] menu and you can adjust the print darkness.

1. When the product is in Online mode, press the  button to change to Offline mode.



2. Press the  button to show the [Settings] menu.

3. Press the ◀/▶ buttons to select [Printing], and then press the ⏪ button.

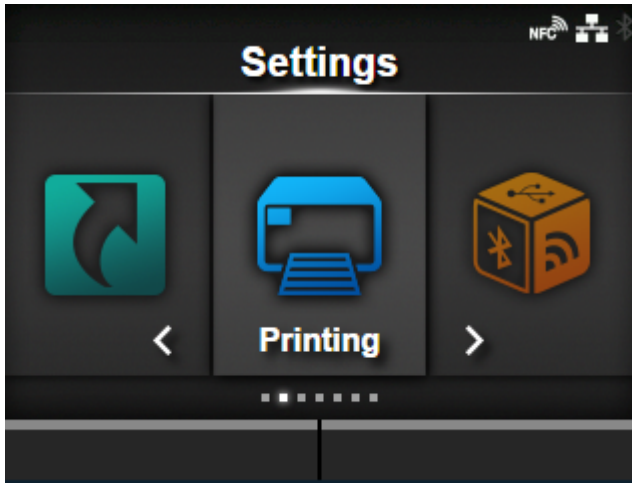

4. Press the ▲/▼ buttons to select [Darkness], and then press the ⏪ button.

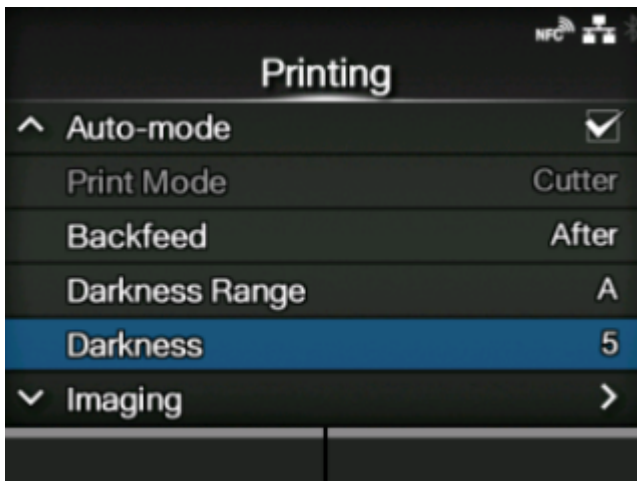



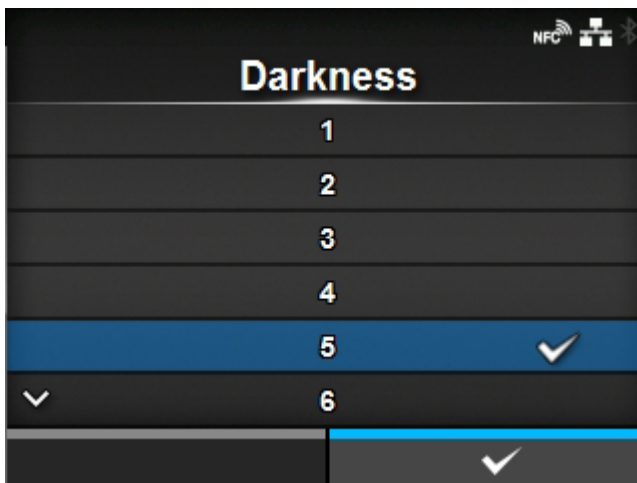

The [Darkness] screen appears.

5. Press the ▲/▼ buttons to select a value.



The setting range is from 1 to 10. 1 is the lightest and 10 is the darkest.

6. Press the  button or  button to save the setting value.
7. Press the  button to change to Offline mode.
8. Press the  button again to change to Online mode.

You can print to check the print quality.

Adjusting the Print Speed

The adjustment of the print speed not only changes the speed of printing but also affects the print quality.

The setting range of the print speed varies depending on the following print resolution:

Resolution	CL4NX Plus	CL6NX Plus
203 dpi (8 dots/mm)	2 to 14 (inches/sec) (50.8 to 355.6 mm/sec)	2 to 10 (inches/sec) (50.8 to 254 mm/sec)
305 dpi (12 dots/mm)	2 to 14 (inches/sec) (50.8 to 355.6 mm/sec)	2 to 8 (inches/sec) (50.8 to 203.2 mm/sec)
609 dpi (24 dots/mm)	2 to 6 (inches/sec) (50.8 to 152 mm/sec)	-



- When the [Printing] > [Advanced] > [Prioritize] menu has been set to [Commands] and the print speed is specified by command, the data will be printed with the print speed specified by the command.
- While the print job is paused, the [Adjustments] menu will appear instead of the [Settings] menu and you can adjust the print speed.
- If the optional dispenser unit is installed to CL4NX Plus, and [Dispenser] is selected in the [Print Mode] menu, the setting range is 2 to 10 (inches/sec) (50.8 to 254 mm/sec) (If the print resolution is 203 dpi or 305 dpi).
- If the optional linerless cutter kit is installed to CL4NX Plus, the setting range is 2 to 6 (inches/sec) (50.8 to 152 mm/sec) regardless of the printing resolution.

1. When the product is in Online mode, press the  button to change to Offline mode.



2. Press the  button to show the [Settings] menu.

3. Press the  /  buttons to select [Printing], and then press the  button.

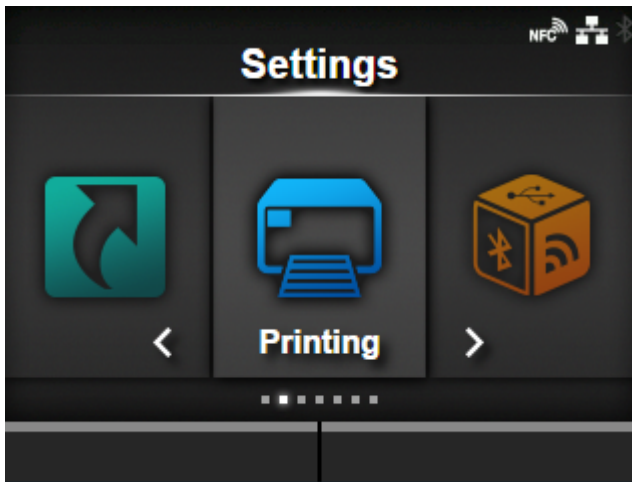

4. Press the  /  buttons to select [Speed], and then press the  button.



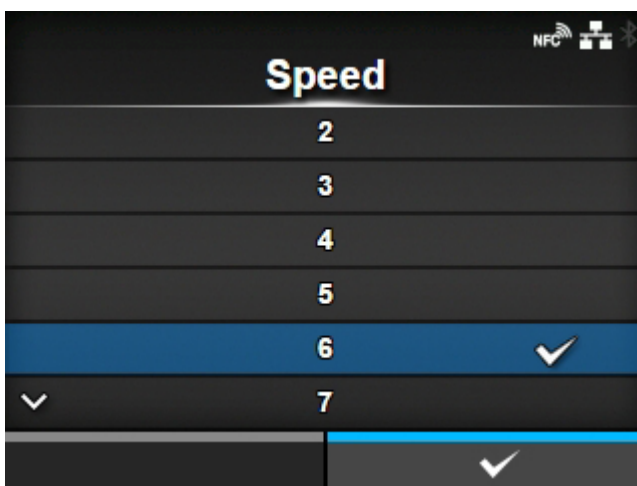

The [Speed] screen appears.

5. Press the  /  buttons to select a value.



6. Press the  button or  button to save the setting value.

7. Press the  button to change to Offline mode.
8. Press the  button again to change to Online mode.



You can print to check the print quality.

Adjusting the Product's Buzzer Volume

The adjustment procedure for the buzzer volume when an error occurs is as follows:

1. When the product is in Online mode, press the  button to change to Offline mode.



2. Press the  button to show the [Settings] menu.
3. Press the  buttons to select [System], and then press the  button.

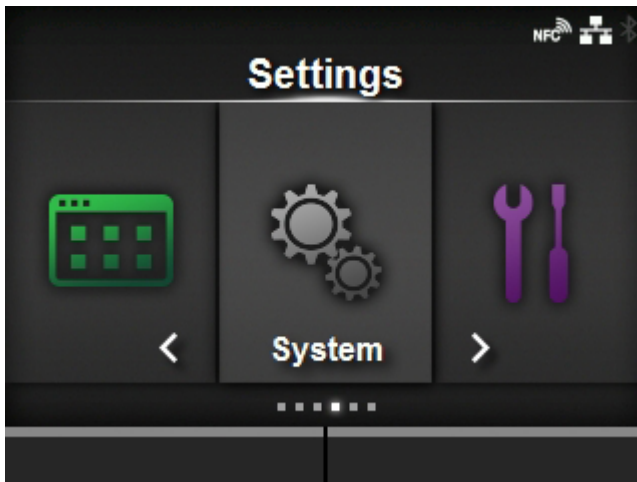

4. Press the ▲ / ▼ buttons to select [Sound] > [Error Sound], and then press the ◀ button.

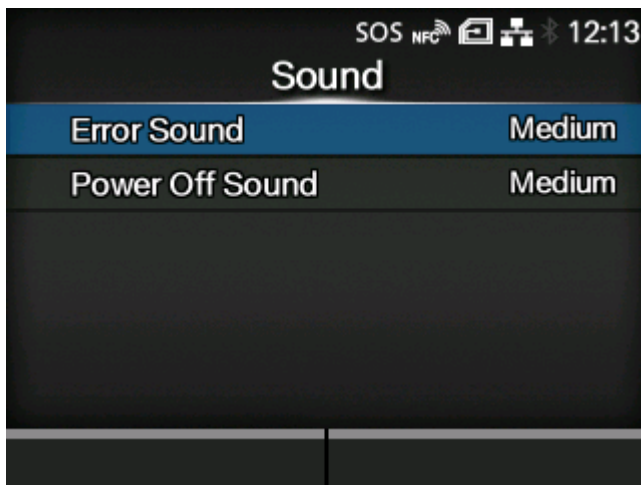

The [Error Sound] screen appears.

5. Press the ▲ / ▼ buttons to set the volume.

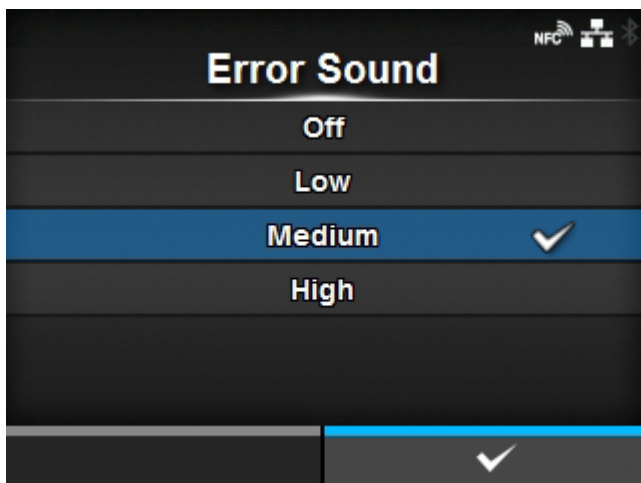

The options are as follows:

[Off]

Mute the sound.

[Low]

Low volume.

[Medium]

Medium volume.

[High]

High volume.

6. Press the ⏪ button or ◀ button to save the setting.

Adjusting the Head Pressure Balance

Print Head Balance

Print head balance refers to the equalization of pressure between the print head and the platen roller. If the print head balance is out of adjustment, the printed image will be darker on one side of the media than the other and the media will be prone to travel in the direction of greater pressure.

Setting the Criteria of the Head Pressure Balance

The criteria of the head pressure balance is set to adapt to the using media.

- Set the head pressure according to the media thickness, including the liner.
- Set the pressure balance according to the media width (if necessary).

Head Pressure Setting

Set the head pressure according to the media thickness, including the liner.

1. Open the top cover of the product.
2. Find the adjustment dials (1) on the top of the print head assembly.

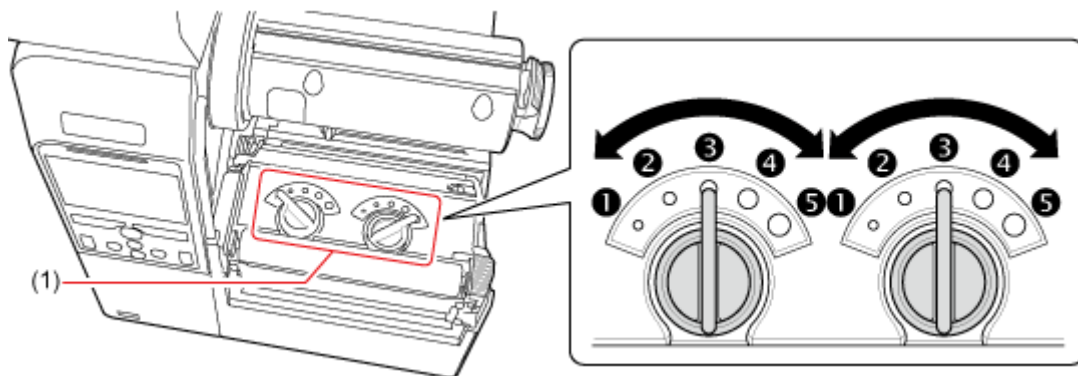

3. Turn the adjustment dials (1) according to the media thickness and set the head pressure.

Media Thickness (mm (inch))	0.060 - 0.200 (0.0024" - 0.0079")	0.200 - 0.268 (0.0079" - 0.011")
Adjustment Dials	<p>③ (Left and Right, CL4NX Plus only)</p> <p>③ to ④ (Left and Right, CL6NX Plus only)</p>	<p>④ to ⑤ (Left and Right)</p>
Reference	Thin paper/normal label, etc.	Thick paper/tag, etc.



- The factory default settings of both Left and Right dials are ③.
- For CL6NX Plus dispenser model, the factory default settings of both Left and Right dials are ④.
- The thickness of the media includes the liner.

After adjusting the head pressure, perform actual printing and if media feeding starts to shift to the right side when facing the product, adjust the pressure balance referring to the Pressure Balance Setting.

Pressure Balance Setting

After adjusting the head pressure, if media feeding starts to shift to the right side when facing the product, adjust the pressure balance referring to this procedure.

Set the pressure balance according to the media width to be used.

1. Open the top cover of the product.
2. Find the adjustment dials (1) on the top of the print head assembly.

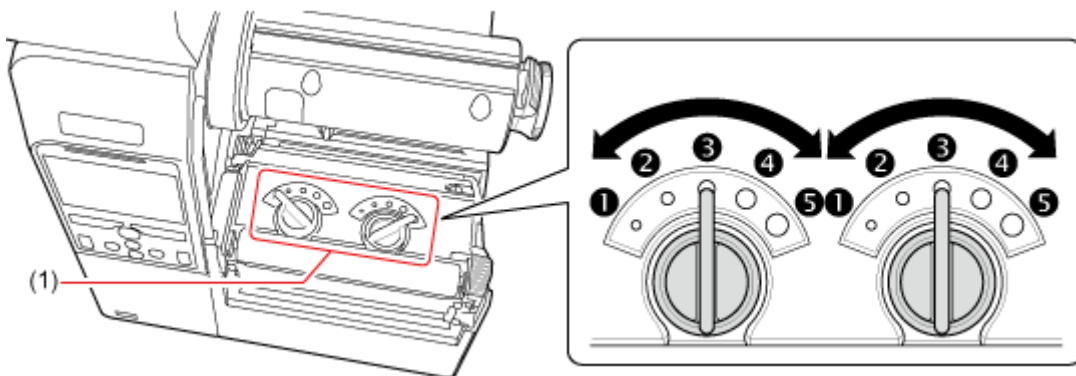

3. Turn the adjustment dials (1) according to the media width and set the pressure balance.

The table below shows an example of when the head pressure is Left **3**.

For CL4NX Plus:

Media Width (mm (inch))	25 - 54 (0.98" - 2.13")	54 - 83 (2.13" - 3.27")	83 - 131 (3.27" - 5.16")
Adjustment Dials	Left 3 Right 1	Left 3 Right 2	Left 3 Right 3

When Micro Label Print Mode for CL4NX Plus is enabled:

Media Width (mm (inch))	25 - 54 (0.98" - 2.13")	54 - 83 (2.13" - 3.27")	83 - 131 (3.27" - 5.16")
Adjustment Dials	Left 5 Right 1	Left 5 Right 3	Left 3 Right 3

For CL6NX Plus:

Media Width (mm (inch))	50 - 120 (1.97" - 4.72")	120 - 140 (4.72" - 5.51")	140 - 160 (5.51" - 6.30")	160 - 180 (6.30" - 7.09")
-------------------------	--------------------------	---------------------------	---------------------------	---------------------------

Adjustment Dials	Left 5 Right 1	Left 3 or 4 Right 1	Left 3 or 4 Right 2	Left 3 or 4 Right 3 or 4
------------------	---------------------------------	---	---	---

When Micro Label Print Mode for CL6NX Plus is enabled:

Media Width (mm (inch))	50 - 90 (1.97" - 3.54")	90 - 130 (3.54" - 5.12")	130 - 180 (5.12" - 7.09")
Adjustment Dials	Left 5 Right 1	Left 5 Right 3	Left 3 Right 3



- The factory default settings of both Left and Right dials are **3**.
- For CL6NX Plus dispenser model, the factory default settings of both Left and Right dials are **4**.
- The dial setting values in the table are only for reference, and the values may vary depending on the media type. Be sure to check if the print quality is stable by actually printing.

RFID Settings (RFID Models Only)

Usable RFID Standards

The RFID standards that can be used with the RFID module are as follows:

RFID Standard	UHF (920 MHz)	HF (13.56 MHz) (CL4NX Plus only)
ISO/IEC 18000-6 Type C Gen2	Available	-
ISO/IEC 15693 <ul style="list-style-type: none"> • ICODE SLI/SLIX/SLIX-S • Tag-it HF-I • my-d 	-	Available
ISO/IEC 14443 Type A <ul style="list-style-type: none"> • NTAG203 • NTAG210/213/215/216 • MIFARE UltraLight • MIFARE UltraLight C • my-d move NFC 	-	Available
ISO/IEC18092 <ul style="list-style-type: none"> • FeliCa Lite-S 	-	Available

Configuring the Product to Encode Inlays

This topic explains the procedures on how to configure the product to encode your inlays.



1. Examine the media to determine the product settings.

Refer to the Inlay Configuration Guide for the measurements you should take and what they mean, as well as a list of inlays and their required configurations.

To see the Inlay Configuration Guide, access the following URL:

<https://www.sato-global.com/rfid/guide.html>

To use inlays that are not in the Inlay Configuration Guide, contact your SATO sales representative or reseller.

2. Press the  power button of the operator panel until the LED lights up in blue to power on the product.
3. When the product is in Online mode, press the  button on the operator panel to change to Offline mode.



4. Press the  button to show the [Settings] menu.

5. Press the ◀/▶ buttons to select [Interface] and then press the ↩ button.

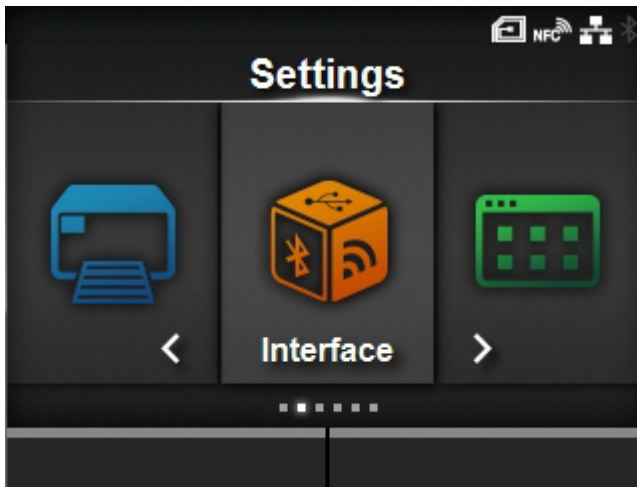

6. Press the ▲/▼ buttons to select [RFID] and then press the ↩ button.

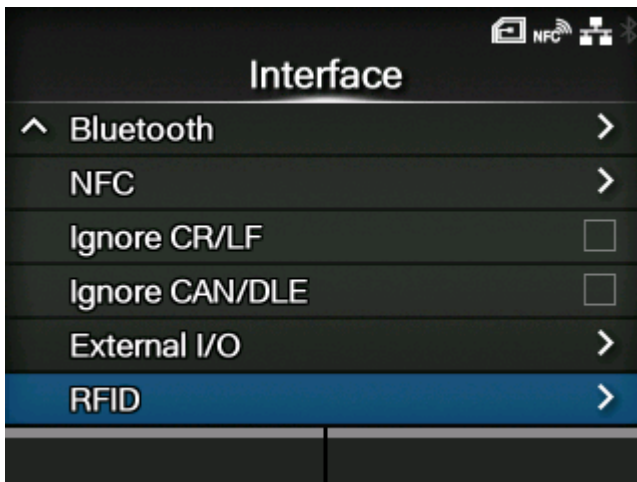

The [RFID] screen appears.

7. Press the ▲ / ▼ buttons to select the item you want to set and then press the ↵ button.

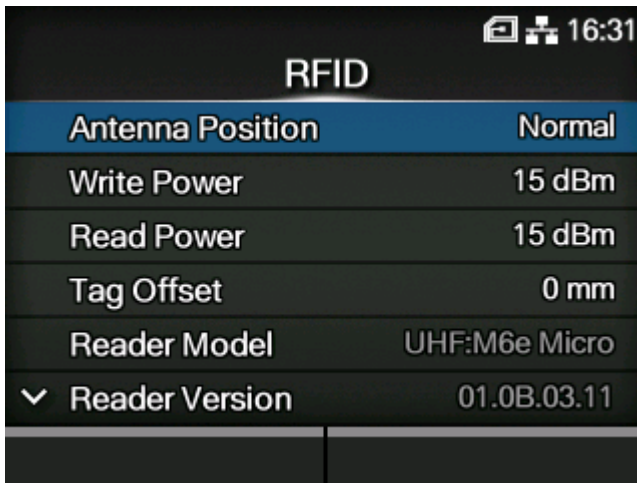

RFID	
Antenna Position	Normal
Write Power	15 dBm
Read Power	15 dBm
Tag Offset	0 mm
Reader Model	UHF:M6e Micro
Reader Version	01.0B.03.11

The adjusting screen appears.

8. **Load the media and ribbon.**
9. **Confirm the operation by printing/encoding a media.**

Make sure that you read the data and check that it is correctly encoded.

Setting Write/Read Conditions Appropriate for RFID Tags

Using the SATO RF Analyze Function to Measure RFID Tags

Use the SATO RF Analyze function to measure an RFID tag.

This function automatically moves the product's RFID standard antenna to measure RFID tags, and determine the conditions to consistently write and read them. The results of the measurement are immediately applied to the product. Furthermore, by saving them as an RFID tag model, you can easily access the settings when using the same RFID tags.



- The length from the leading edge of the tag to the inlay should be 15 mm (0.59") or more.
- The tag length should be 42 mm (1.65") or more (including liner) to execute SATO RF Analyze.
- Keep the setting value of the radio power level 24 dBm or less.

Setting Measurement Conditions

Before executing measurement, set the search level, writing/reading power (UHF modules only), and name for saving as an RFID tag model.

Set the writing/reading power according to the Inlay Configuration Guide. For details, access the following URL:

<https://www.sato-global.com/rfid/guide.html>

To use inlays that are not in the Inlay Configuration Guide, use the initial values.

1. When the product is in Online mode, press the  button on the operator panel to change to Offline mode.



2. Press the  button to show the [Settings] menu.

3. Press the  /  buttons to select [Interface], and then press the  button.

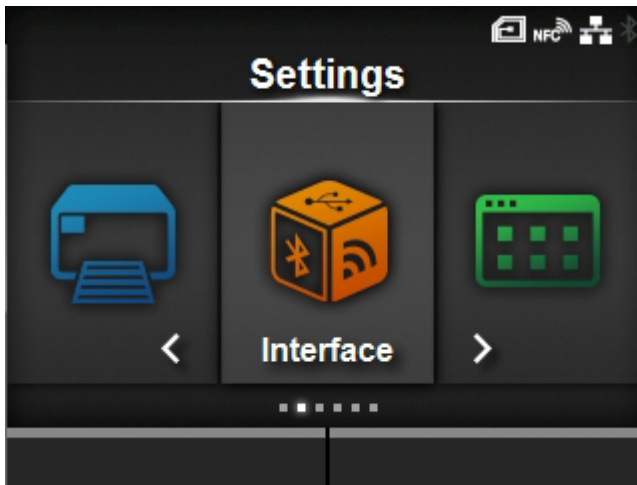

4. Press the  /  buttons to select [RFID] > [SATO RF Analyze], and then press the  button.

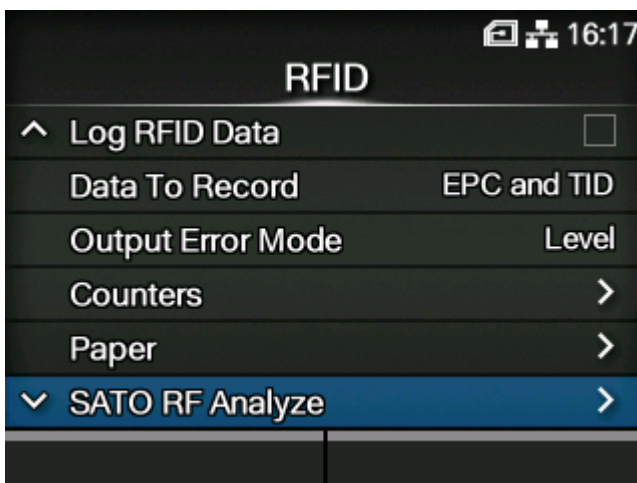

5. Press the  /  buttons to select [Search Level], and then press the  button.

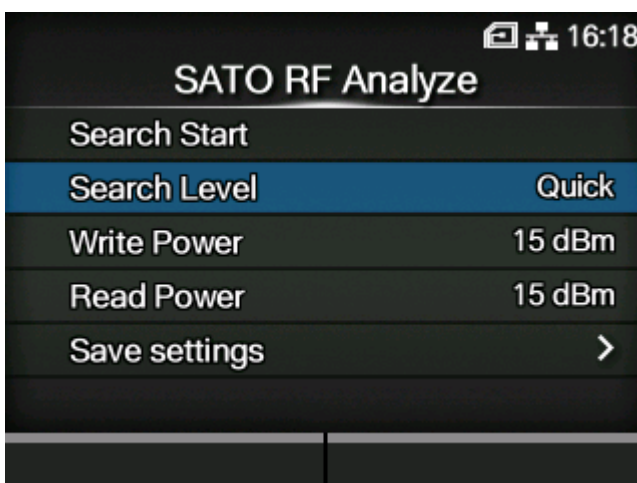

6. Press the ▲ / ▼ buttons to select the search level to execute, and then press the ← button.

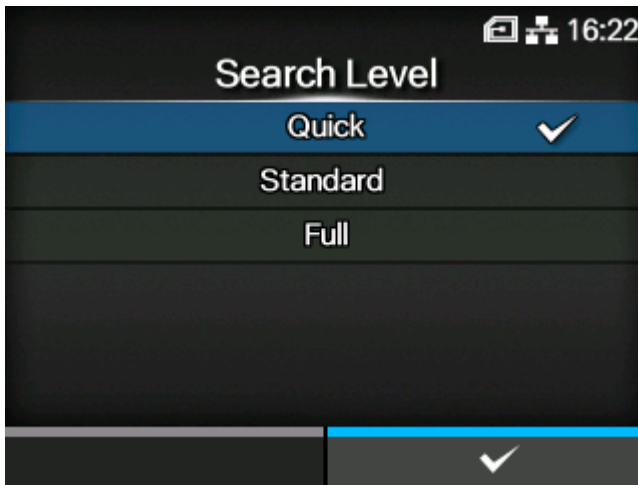

7. If you are using a UHF module, press the ▲ / ▼ buttons to select [Write Power], and then press the ← button.

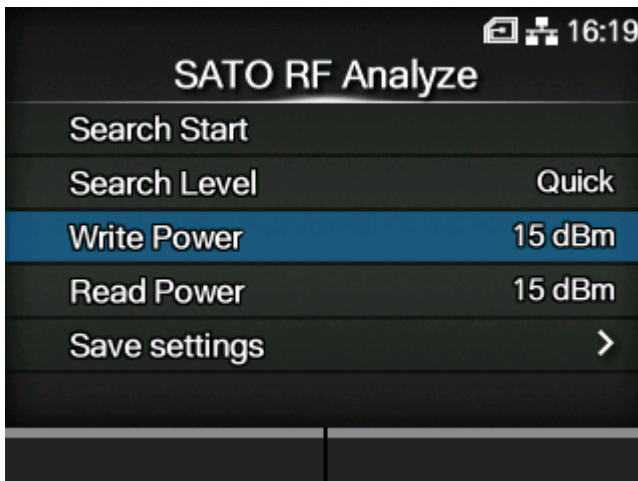

8. Set the writing power, and then press the ⋮ button to save the setting.

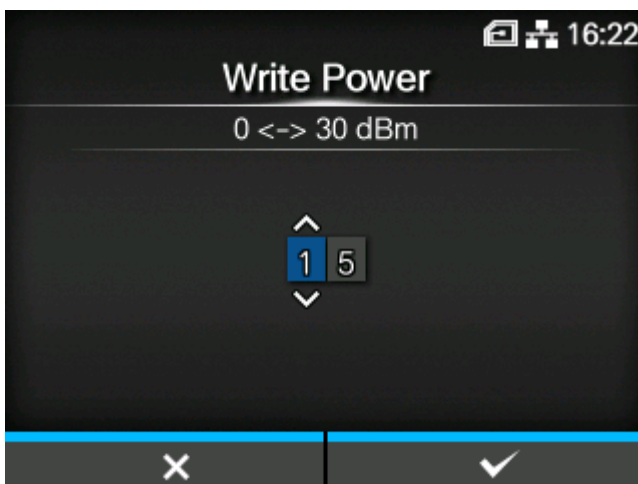



- Keep the setting value 24 dBm or less.

9. If you are using a UHF module, press the ▲ / ▼ buttons to select [Read Power], and then press the ← button.

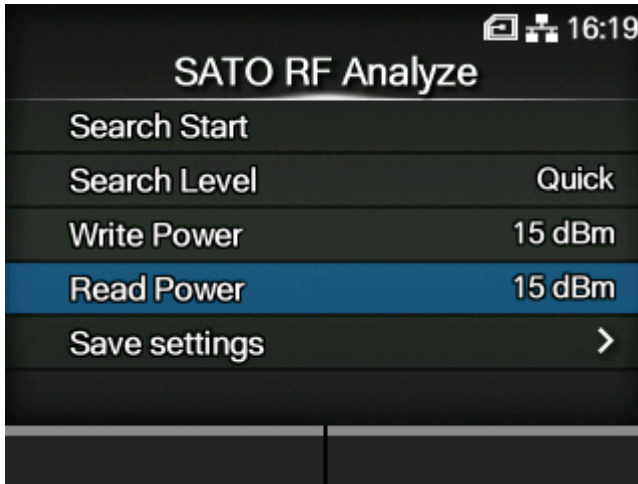

10. Set the reading power, and then press the ⋮ button to save the setting.

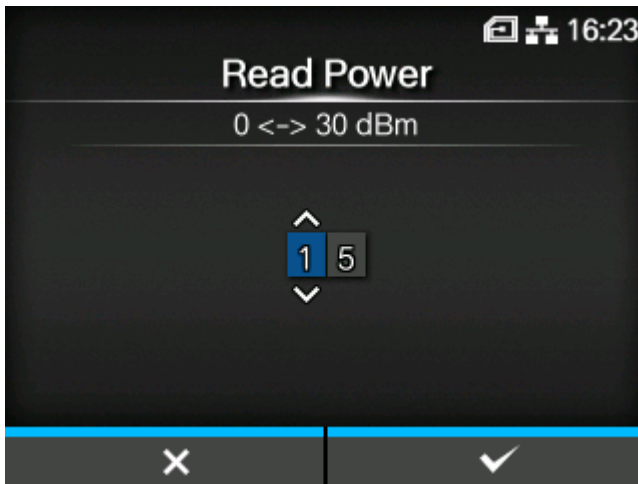

- Keep the setting value 24 dBm or less.

11. Press the ▲ / ▼ buttons to select [Save settings], and then press the ← button.

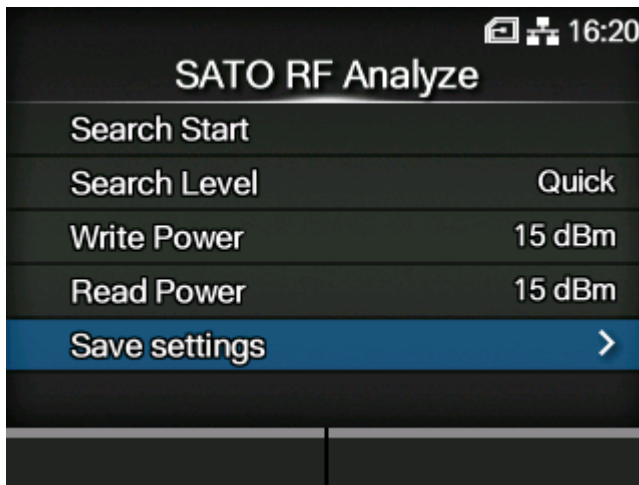

12. Press the ▲ / ▼ buttons to select [Model Name], and then press the ← button.

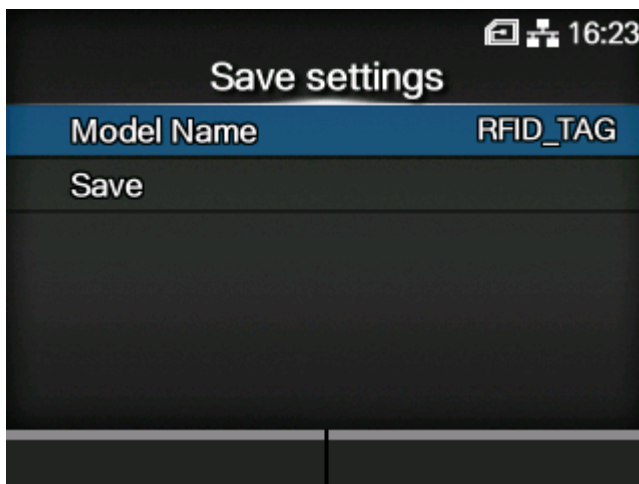

13. Edit the name of the model under which to save the measurement results, and then press the  button.

You can enter a maximum of 32 characters. You can use alphabet (capital and small letters), numbers and symbols.



- If you save them without inputting a model name, the model name will be saved as the default, "RFID_TAG".

Executing SATO RF Analyze

Execute SATO RF Analyze using the measurement conditions that you set.

14. Set the RFID tag to the product.
15. Select [Search Start] on the [SATO RF Analyze] screen, and then press the  button.

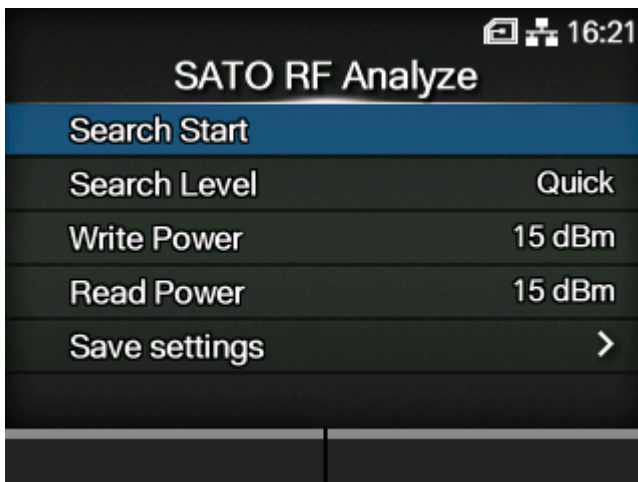

16. Press the  button on the confirmation screen.

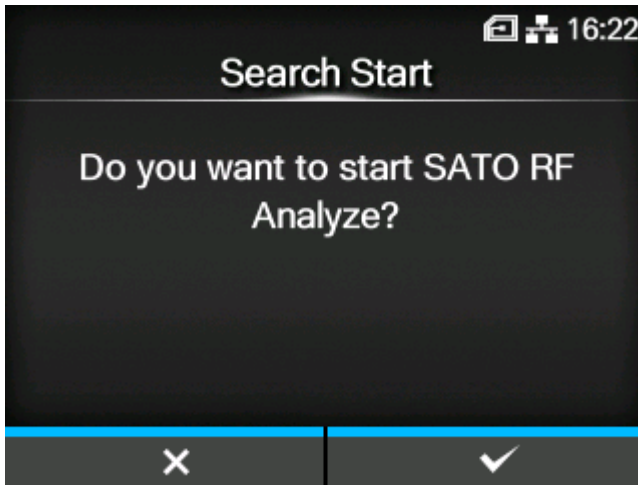

Measurement starts, and the state of the measurement appears on the screen.

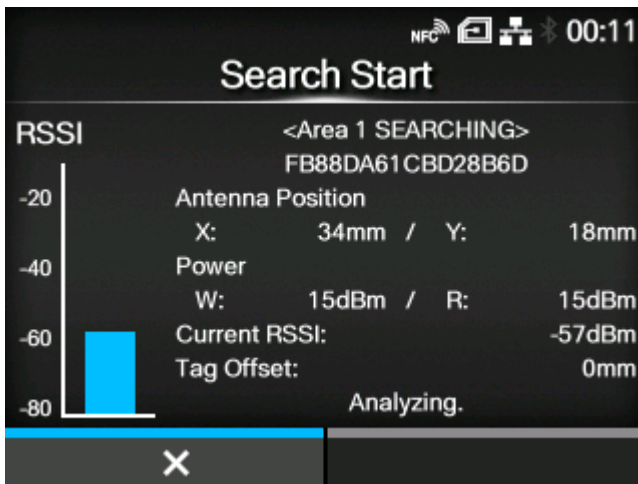

17. When the measurement is complete and [FINISH] is displayed, press the  button.

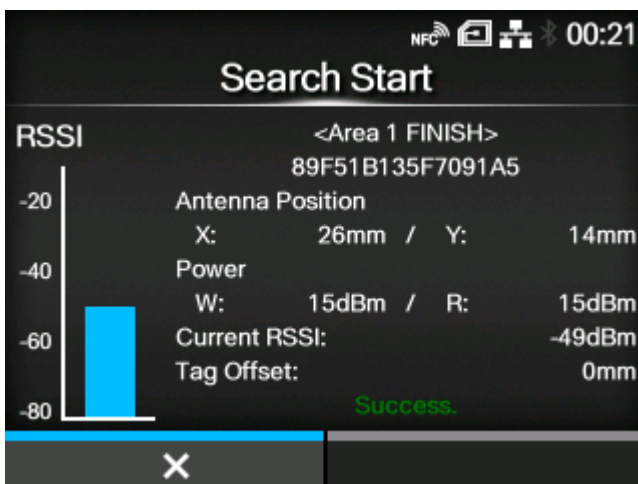

18. To save the measurement results as an RFID tag model, press the  button. To not save them, press the  button.

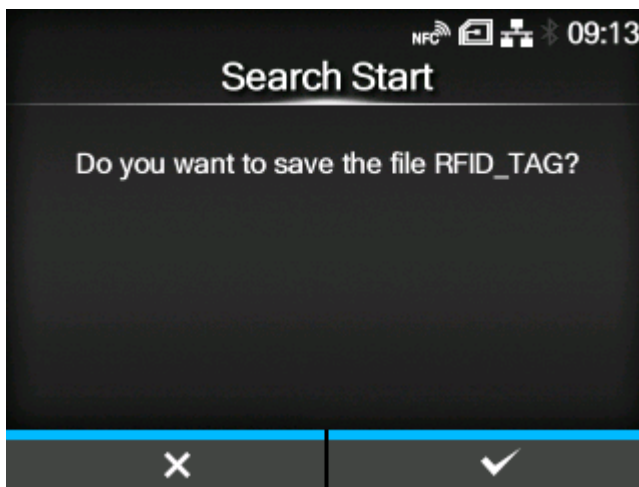

- If a measurement fails, a message to adjust the [Write Power] and [Read Power] values by +1 dBm or -1 dBm, according to the cause, appears. Press the  button to execute adjustment, and then do the measurement again.
- Do not open the top cover while measuring. If you open the top cover before you close the message asking you whether to save the settings, you will need to do the measurement again.
- Do not send a DC2 command to the product while measuring. If the radio power setting or reset command is received, the measurement will not finish correctly.
- Do not do more than 10 measurements consecutively. If you need to do 11 or more measurements, allow the RFID module to cool before doing so.
- If an error occurs while measuring and the measurement is interrupted, the display returns to the confirmation screen regardless of the error type.

Loading the Saved RFID Tag Model



By saving SATO RF Analyze results as RFID tag models for each RFID tag you are using, you can easily change the product's settings when you change RFID tags.

RFID tag models can be selected from the [Interface] > [RFID] > [RFID Tag Model] > [Load] menu and applied to the product.

The procedure to load the RFID tag model is as follows:

1. When the product is in Online mode, press the  button on the operator panel to change to Offline mode.



2. Press the  button to show the [Settings] menu.
3. Press the  buttons to select [Interface], and then press the  button.

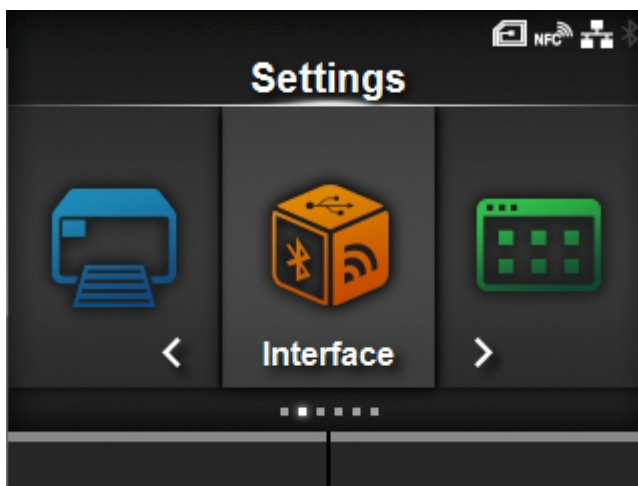

4. Press the ▲ / ▼ buttons to select [RFID] > [RFID Tag Model], and then press the ⬅ button.

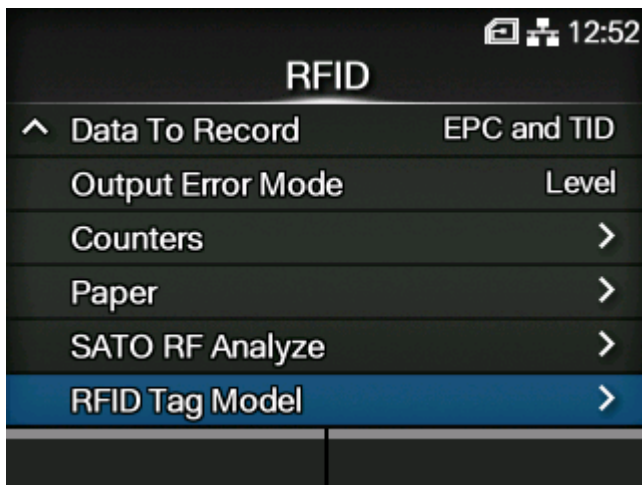

5. Press the ▲ / ▼ buttons to select [Load], and then press the ⬅ button.

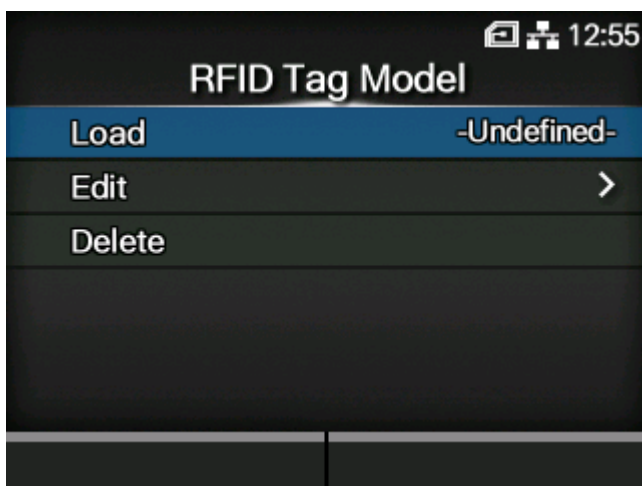

6. Press the ▲ / ▼ buttons to select the RFID tag model to load.

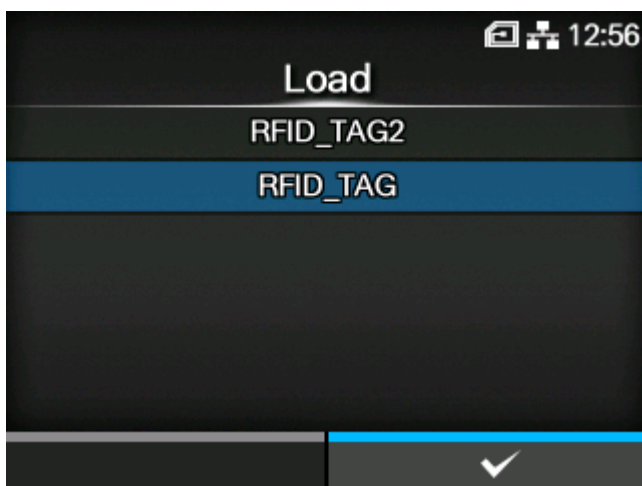

7. Press the ☰ button or ⬅ button to confirm.

8. Press the  button on the confirmation screen.

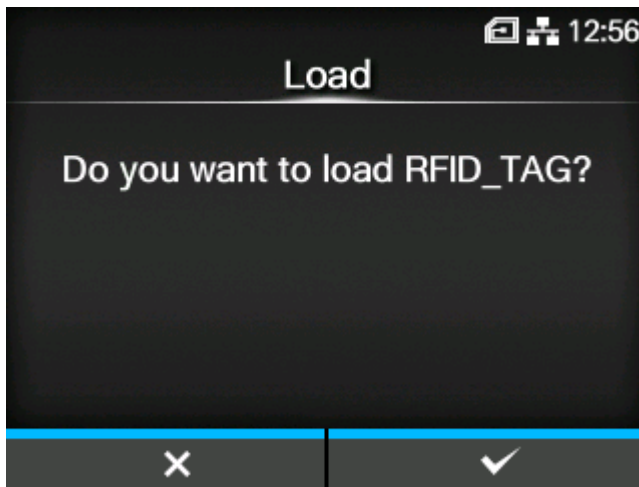

9. Press the  button on the completion screen.

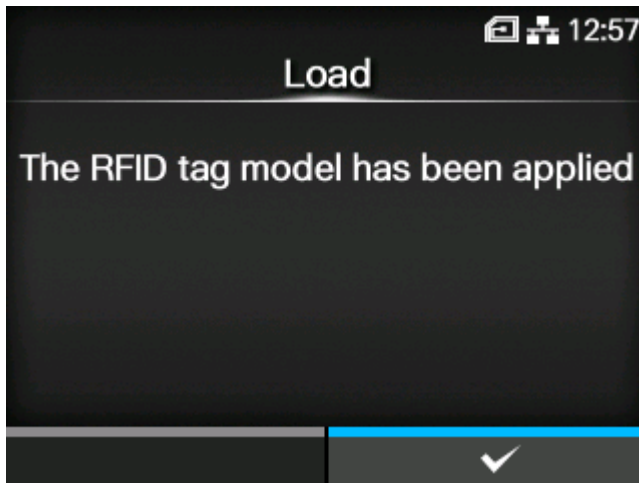

The settings loaded from the RFID tag model are applied to the product. The name of the loaded RFID tag model appears on the right side of [Load] on the [RFID Tag Model] menu.

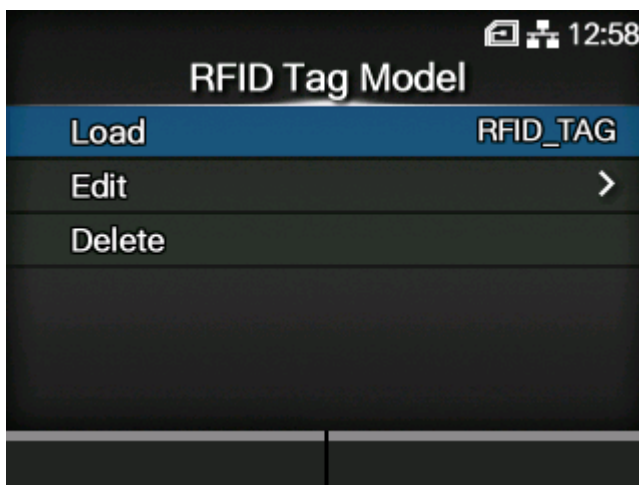



- From the [RFID Tag Model] > [Edit] menu, you can change settings in registered RFID tag models or manually register new RFID tag models.
-

Printing RFID Tag Errors

If the recorded data on a tag is incomplete due to writing on a defective tag, the product will print an RFID tag error to the defective media. This function is to prevent the distribution of defective media with a tag error.

When an RFID tag error occurs, the product prints a slash and the error message, such as "WRITE TAG ERROR" or "TAG NOT FOUND". The position to print the message and slash is set using the specified media size command <A1>.

For a write error such as "WRITE TAG ERROR", the product continues to print the first 16 or 32 bytes of the write data.

The diagram below shows the message and slash printed on the position based on the media size specified by the normal print.



- If the installed module is HF, a hex dump of UID may be printed depending on the tag type and the timing of error occurring.

WRITE TAG ERROR in RFID Write Command READ TAG ERROR in RFID Read Command

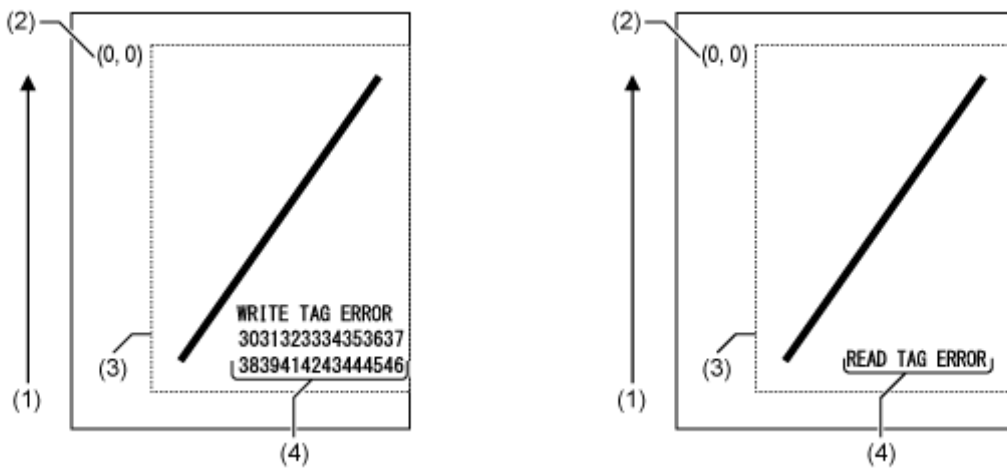

For other errors, the product prints the error message accordingly.

TAG NOT FOUND Error in RFID Write/Read Command

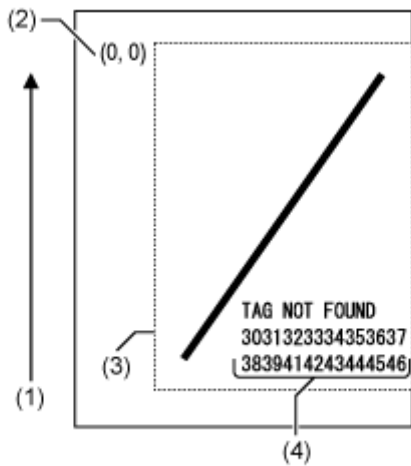

- (1) Feed direction
- (2) The origin of the range specified by the media size command <A1>
- (3) The range specified with the media size command <A1>
- (4) The dump for the first 16 or 32 bytes of the write data



- When a character overlaps with the slash, the character will inverse from black to white.



When using a small-size label (about the size of P30 X W40 mm (P1.18" X W1.57"), for example) or not enough for setting margin, the slash and error message are printed overlap on each other. The overlapped area are inverse from black to white. There is no dump printing.

TAG NOT FOUND Error in RFID Write Command

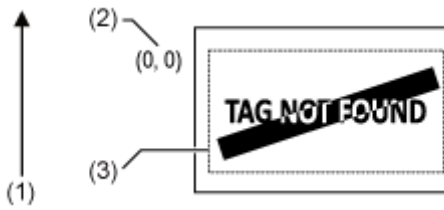

- (1) Feed direction
- (2) The origin of the range specified by the media size command <A1>
- (3) The range specified with the media size command <A1>

If not specified by the media size command <A1>, the product prints the RFID error using a fixed size of P30 X W40 mm (P1.18" X W1.57"). When a character overlaps with the slash, the character will inverse from black to white.

WRITE TAG ERROR in RFID Write Command READ TAG ERROR in RFID Read Command

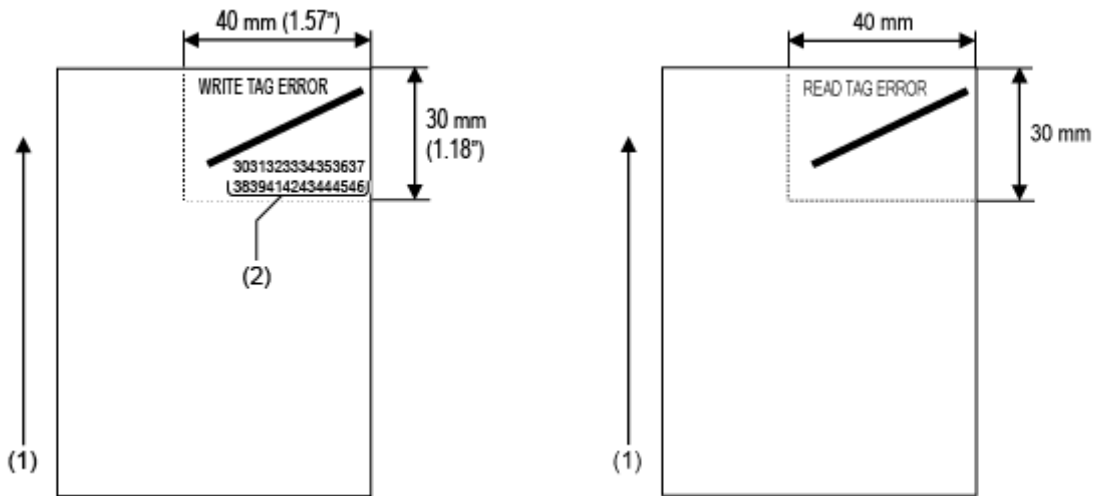

For other errors, the product prints the error message accordingly.

TAG NOT FOUND Error in RFID Write/Read Command

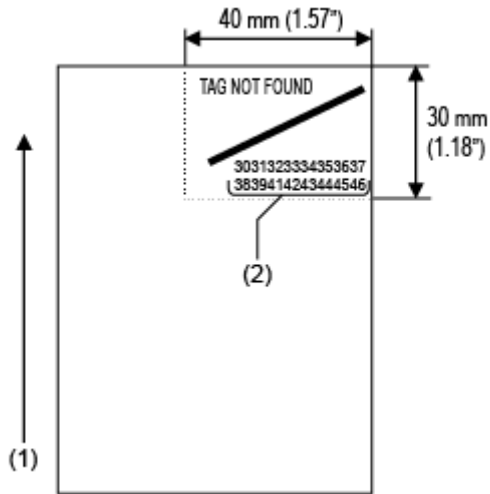

(1) Feed direction

(2) The dump for the first 16 or 32 bytes of the write data

The types of errors to print are as follows:

Message	Cause and Countermeasure
TAG NOT FOUND	<p>Cause</p> <p>Did not find the tag to print, or failed to read the tag.</p> <p>Countermeasure</p> <p>Confirm the inlay operation and check the product/antenna settings.</p>
WRITE TAG ERROR	<p>Cause</p> <p>Failed to write the tag.</p> <p>Countermeasure</p> <p>Confirm the inlay operation and check the product/antenna settings.</p>
READ TAG ERROR	<p>Cause</p> <p>Failed to read tag using <TU> command.</p> <p>Countermeasure</p> <ol style="list-style-type: none"> 1. Check inlay, printer/antenna settings. 2. Check if the address size exceeds the maximum tag capacity.
VERIFY UID ERROR	<p>Cause</p> <p>Failed to replace the loaded tag.</p>

Message	Cause and Countermeasure
	<p>Countermeasure</p> <p>Confirm the inlay operation and check the product/antenna settings.</p>
PROTECT TAG ERR	<p>ISO/IEC 15693, FeliCa only</p> <p>Cause</p> <ol style="list-style-type: none"> 1. Tried to write to a locked tag. 2. Tried to write to an address that is not permitted. <p>Countermeasure</p> <p>Use tag that is not locked.</p>
VERIFY TAG ERR.	<p>Except FeliCa</p> <p>Cause</p> <p>The written value and read value do not match.</p> <p>Countermeasure</p> <p>Confirm the inlay operation and check the product/antenna settings.</p> <hr/> <p>FeliCa only</p> <p>Cause</p> <p>The written value and read value do not match. A value greater than original data was written to subtraction register.</p> <p>Countermeasure</p> <p>Write an appropriate value to subtraction register.</p>
LOCKING ERROR	<p>Cause</p> <p>Failed to lock the inlay.</p> <p>Countermeasure</p> <p>Check the inlay.</p>
WRONG TID ERROR	<p>ISO/IEC 15693, ISO/IEC 14443 Type A only</p> <p>Cause</p> <p>Read the UID of the inlay other than the specified inlay.</p> <p>Countermeasure</p> <p>Check that the tags you are using are the specified types of tags.</p>
MULTI TAGS ERROR	<p>Except FeliCa</p> <p>Cause</p> <p>Multiple tags detected at a time.</p>

Message	Cause and Countermeasure
	<p>Countermeasure</p> <p>Confirm the inlay operation and check the product/antenna settings.</p> <hr/> <p>FeliCa only</p> <p>Cause</p> <p>The captured IDm of the card is inconsistent between processes. (Tried to write to a wrong card.)</p> <p>Countermeasure</p> <p>Confirm the inlay operation and check the product/antenna settings.</p>
READ ONLY ERROR	<p>UHF only</p> <p>Cause</p> <ol style="list-style-type: none"> 1. Tried to write to a write-locked inlay. 2. Tried to write to an inlay when the write power is low. <p>Countermeasure</p> <ol style="list-style-type: none"> 1. Use tag that is not locked. 2. Adjust [Write Power]/[Read Power].
DIFFER TAG KIND	<p>ISO/IEC 15693, ISO/IEC 14443 Type A only</p> <p>Cause</p> <p>Incorrect tag type is specified.</p> <p>Countermeasure</p> <p>Check the tag type, and specify the correct tag type.</p>
LOST HANDLE ERR	<p>ISO/IEC 15693, ISO/IEC 14443 Type A, FeliCa only</p> <p>Cause</p> <p>Failed to acquire the ID.</p> <p>Countermeasure</p> <p>Improve the radio wave condition.</p>
POWER NOT ENOUGH	<p>UHF only</p> <p>Cause</p> <p>The RSSI value of the RFID tag has fallen below the value set in [Interface]>[RFID]>[Filter Function]>[Threshold Value] as result of enabling the RSSI filter function.</p> <p>Countermeasure</p> <ol style="list-style-type: none"> 1. Check inlay and [Threshold Value] for RSSI filter. 2. Adjust [Write Power]/[Read Power].

Message	Cause and Countermeasure
ADDRESS EXCEED	<p>ISO/IEC 15693 only</p> <p>Cause</p> <ol style="list-style-type: none"> 1. Tried to write the data to the memory which exceeds the address range. 2. The memory does not exist in the memory block address where the data should be written. <p>Countermeasure</p> <ol style="list-style-type: none"> 1. Check if the address size exceeds the maximum inlay capacity. 2. Check the data size.

RFID Error and Reset Timing

Error Signal Output with One-shot Pulse

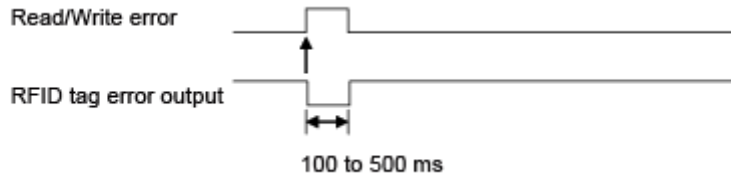

Error Signal Output with Long Pulse

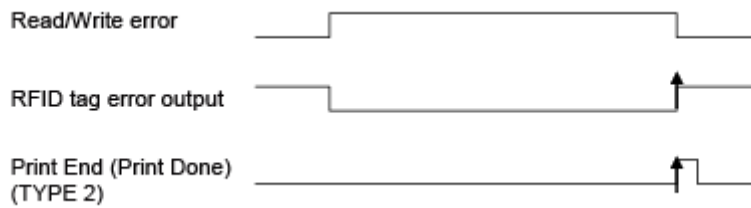

When the reprint count reaches the specified number, the RFID tag error and machine error are outputted at a time. The machine error output is always a long pulse.

Timing Chart of Error Signal Output with One-shot Pulse

Item	RFID Reprint Twice - One-shot Pulse Output Waveform
Error	
Reprint 1st	

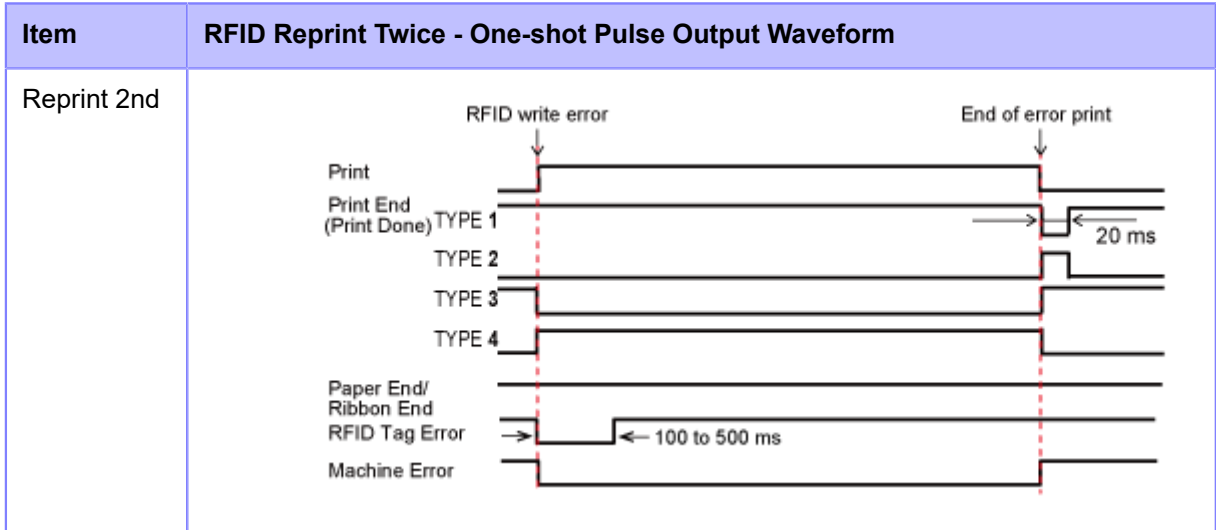

Timing Chart of Error Signal Output with Long Pulse

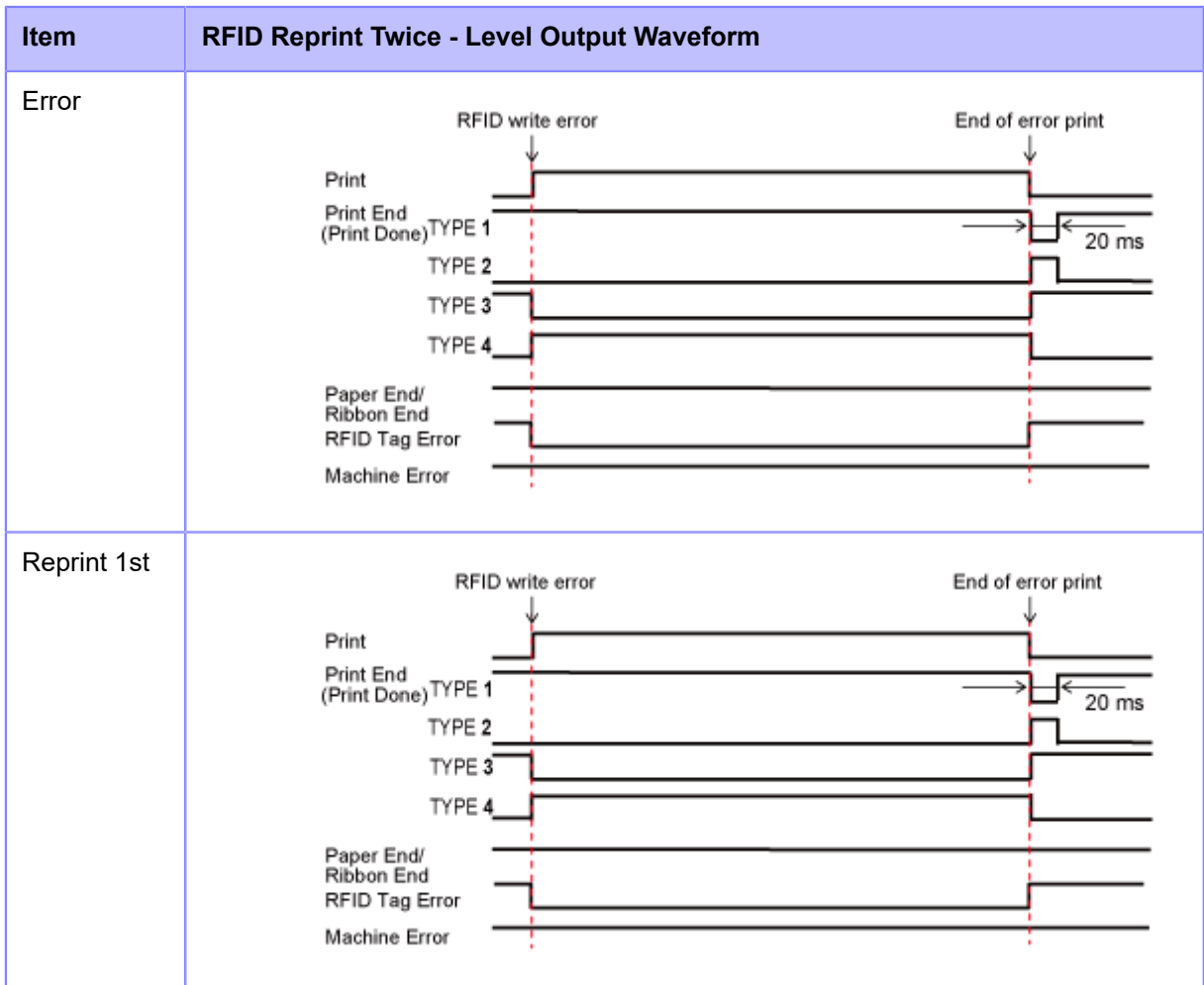

Item	RFID Reprint Twice - Level Output Waveform
Reprint 2nd	<p>The diagram illustrates the timing of a reprint after an RFID write error. Key events include:</p> <ul style="list-style-type: none"> RFID write error: Occurs at the beginning of the print cycle. End of error print: Occurs after the initial print attempt. 20 ms delay: A specific time interval between the end of the error print and the start of the reprint. Print and Print End (Print Done): Signals that show the duration of the print cycle, including the reprint. TYPE 1-4, Paper End/Ribbon End, RFID Tag Error, Machine Error: Other status signals that remain active during the print cycle.

External Signal (EXT) Interfaces When RFID Mode Is Enabled

The following tables are the comparison of EXT signal between RFID mode is disabled or enabled.

RFID Mode Disabled

Standard specification is applied when the RFID mode is disabled.

Pin No.	Signal	I/O
1	Paper End	Output
2	Ground	-
3	Ribbon End	Output
4	Machine Error	Output
5	Print Start (PRIN)	Input
6	Print Done/Print End (PREND)	Output
7	Reprint (PRIN2)	Input
8	External Power Supply	Input
9	Online	Output
10	Ribbon Near End	Output
11	N/A	-
12	+24V	Output
13	+5V	Output
14	Frame Ground	-

RFID Mode Enabled

The function indicated in bold text is applied to 1, 3, and 4 of Pin No. when the RFID mode is enabled.

Pin No.	Signal	I/O
1	Paper End + Ribbon End	Output
2	Ground	-
3	RFID Tag Error	Output
4	Machine Error/RFID Error	Output
5	Print Start (PRIN)	Input

Pin No.	Signal	I/O
6	Print Done/Print End (PREND)	Output
7	Reprint (PRIN2)	Input
8	External Power Supply	Input
9	Online	Output
10	Ribbon Near End	Output
11	N/A	-
12	+24V	Output
13	+5V	Output
14	Frame Ground	-

RFID Printing Tips

Recommended Non-printable Zone

Avoid printing barcodes or characters directly on top of an RFID chip. The uneven surface will negatively affect the print quality.

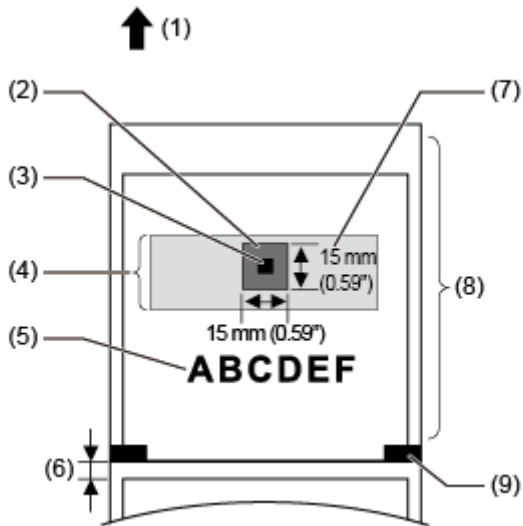



- (1) Feed direction
- (2) Recommended non-printable zone
- (3) IC chip
- (4) Inlay
- (5) Print object
- (6) Gap
- (7) Antenna
- (8) RFID tag/label
- (9) I-mark

Configuring Optional Barcode Check Function

Basic Specifications of the Barcode Check Function

The barcode check function does a reading check of a barcode printed by this product to prevent the distribution of labels with defective barcodes. You can use this function by installing the supported barcode checkers to the product.

The basic specifications of the barcode check function are as follows:

Item	Specification
Supported Barcode Checkers	<ul style="list-style-type: none"> • Made by IDEC/DATALOGIC (USB connection) <ul style="list-style-type: none"> ◦ WB1F-100S1S (for 1D barcodes) ◦ GFS4170 (for 1D barcodes) ◦ GFS4470 (for 1D barcodes/2D codes) • Made by KEYENCE (RS-232C connection) <ul style="list-style-type: none"> ◦ BL-1301 (for 1D barcodes) ◦ SR-710 (for 1D barcodes/2D codes) <p>Refer to the manual of the barcode checker for its settings and supported barcodes.</p>
Supported Commands	<p>SBPL/SZPL/SIPL/STCL/SDPL/SEPL</p> <hr/>  <ul style="list-style-type: none"> • AEP is not supported. <hr/>
Supported Print Modes	<p>Continuous/Cutter/Cut & Print/Dispenser/Linerless (CL4NX Plus only)</p> <hr/>  <ul style="list-style-type: none"> • Not available in Tear-Off mode. • Not available for RFID models. • The Void Print function is not available in Dispenser/Linerless (CL4NX Plus only) mode. <hr/>
Print Speed/Print Darkness	<p>The optimal print speed and print darkness for secure reading vary depending on various conditions, such as the barcode type and label layout. Be sure to perform a test read carefully and determine the settings.</p>
Printable Area (Barcode Readable Area)	<p>Same as the product specifications. However, there are following restrictions:</p>

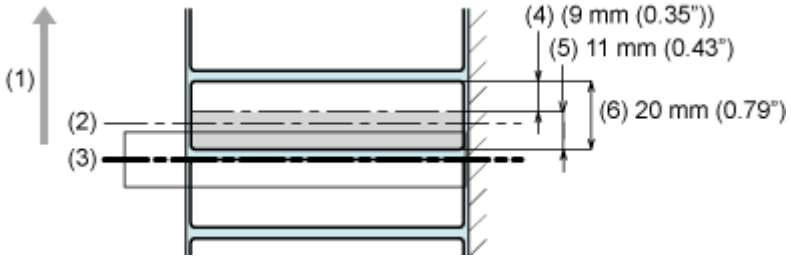
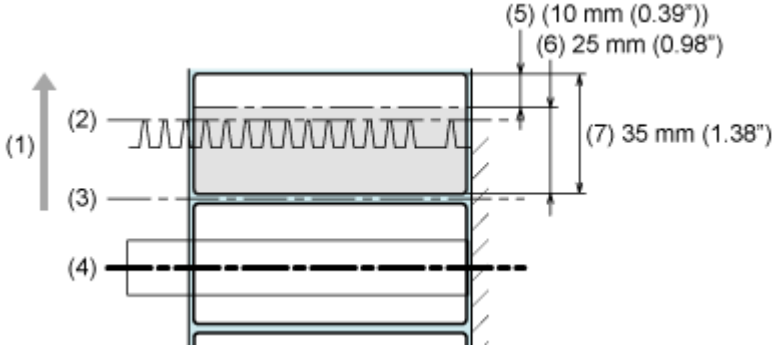
Item	Specification
	<p>Continuous mode</p> <p>Barcodes printed within the range of 11 mm (0.43") from the trailing end of the label cannot be read because it is blocked by the print head and ribbon adjustment plate.</p>  <p>(1) Media feed direction (2) Ribbon adjustment plate (3) Print head (4) Readable area (for the minimum media pitch) (5) Unreadable area (6) Minimum media pitch</p> <p>Cutter/Cut & Print mode</p> <p>Barcodes printed within the following area cannot be read because it is blocked by the cutter cover.</p> <ul style="list-style-type: none"> ◦ Cutter (cutting every label): 25 mm (0.98") from the trailing end of the label  <p>(1) Media feed direction (2) Cutter cover (3) Cut position (4) Print head (5) Readable area (for the minimum media pitch) (6) Unreadable area (7) Minimum media pitch</p> <ul style="list-style-type: none"> ◦ Cutter (cutting according to the specified number of labels)/ Cut & Print: 44 mm (1.73") from the trailing end of the label

Item	Specification
------	---------------

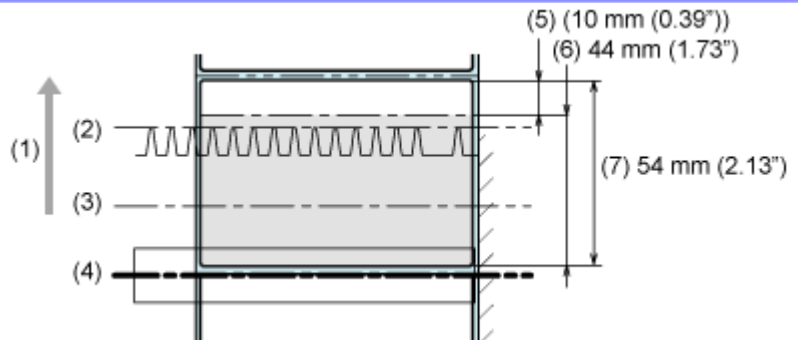

- (1) Media feed direction
- (2) Cutter cover
- (3) Cut position
- (4) Print head
- (5) Readable area (for the minimum media pitch)
- (6) Unreadable area
- (7) Minimum media pitch

Cut & Print mode

Do not print a 2D code or serial barcode (90° or 270° orientation in relation to the media feed direction) within the following area as it may cause a white void.

- CL4NX Plus: 18 to 23 mm (0.70" to 0.90") from the front end of the label (cut position)

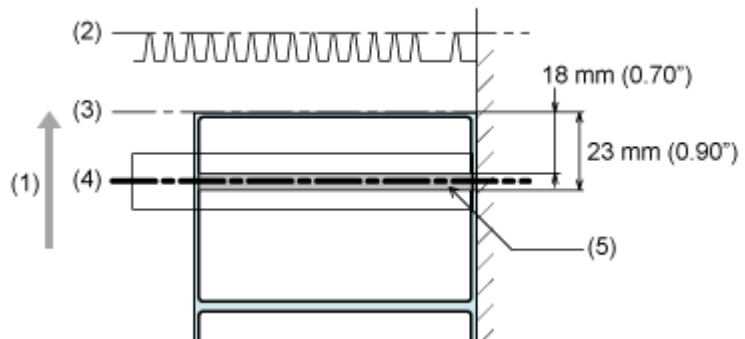

- (1) Media feed direction
- (2) Cutter cover
- (3) Cut position
- (4) Print head
- (5) Range in which white voids occur

- CL6NX Plus: 19 to 25 mm (0.75" to 0.98") from the front end of the label (cut position)

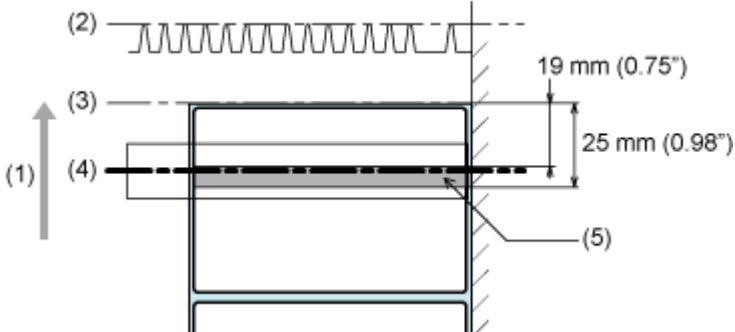
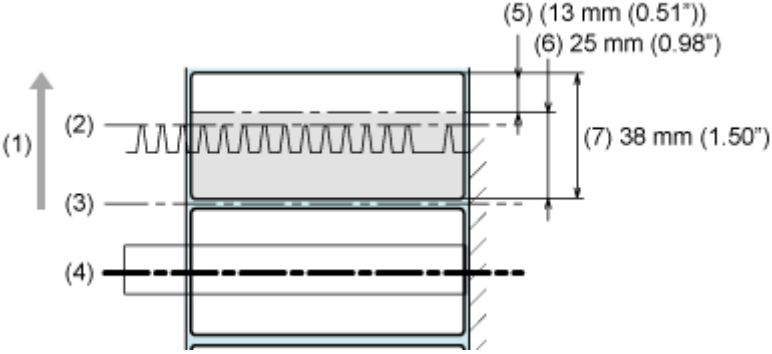
Item	Specification	
	 <p>(1) Media feed direction (2) Cutter cover (3) Cut position (4) Print head (5) Range in which white voids occur</p> <p>Linerless mode (CL4NX Plus only)</p> <p>Barcodes printed within a range of 25 mm (0.98") from the trailing end of the label cannot be read as it is blocked by the cutter cover.</p>  <p>(1) Media feed direction (2) Cutter cover (3) Cut position (4) Print head (5) Readable area (for the minimum media pitch) (6) Unreadable area (7) Minimum media pitch</p>	
Usable Media Sizes	Media width	Same as the product specifications.
	Media Pitch	The minimum size is different from the product specifications. Continuous mode <ul style="list-style-type: none"> ◦ 203 dpi: 20 to 2497 mm (0.79" to 98.30") (with liner: 23 to 2500 mm (0.90" to 98.42")) ◦ 305 dpi: 20 to 1497 mm (0.79" to 58.94") (with liner: 23 to 1500 mm (0.90" to 59.05"))

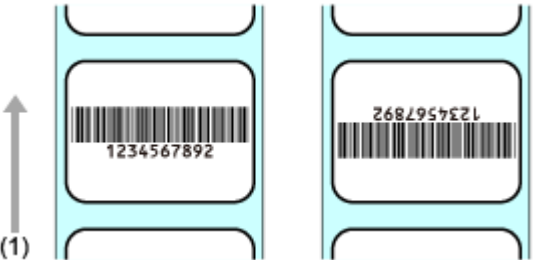
Item		Specification
		<ul style="list-style-type: none"> 609 dpi (CL4NX Plus only): 20 to 397 mm (0.79" to 15.63") (with liner: 23 to 400 mm (0.90" to 15.75")) <p>Cutter mode (cutting every label)</p> <ul style="list-style-type: none"> 203 dpi: 35 to 2497 mm (1.38" to 98.30") (with liner: 38 to 2500 mm (1.50" to 98.42")) 305 dpi: 35 to 1497 mm (1.38" to 58.94") (with liner: 38 to 1500 mm (1.50" to 59.05")) 609 dpi (CL4NX Plus only): 35 to 397 mm (1.38" to 15.63") (with liner: 38 to 400 mm (1.50" to 15.75")) <p>Cutter (cutting according to the specified number of labels)/Cut & Print mode</p> <ul style="list-style-type: none"> 203 dpi: 54 to 2497 mm (2.13" to 98.30") (with liner: 57 to 2500 mm (2.24" to 98.42")) 305 dpi: 54 to 1497 mm (2.13" to 58.94") (with liner: 57 to 1500 mm (2.24" to 59.05")) 609 dpi (CL4NX Plus only): 54 to 397 mm (2.13" to 15.63") (with liner: 57 to 400 mm (2.24" to 15.75")) <p>Dispenser mode</p> <ul style="list-style-type: none"> 27 to 397 mm (1.06" to 15.63") (with liner: 30 to 400 mm (1.18" to 15.75")) <p>Linerless mode (CL4NX Plus only)</p> <ul style="list-style-type: none"> 38 to 120 mm (1.50" to 4.72")
Usable Media Types		Same as the product specifications. If the label color is silver or laminated, however, it makes it difficult for the barcode checker to read the barcode, as the light of the barcode checker may cause a reflection on the label surface. Be sure to do a test read carefully in advance.
Readable Barcode Orientations	1D Barcode Checker	 <p>(1) Media feed direction</p>

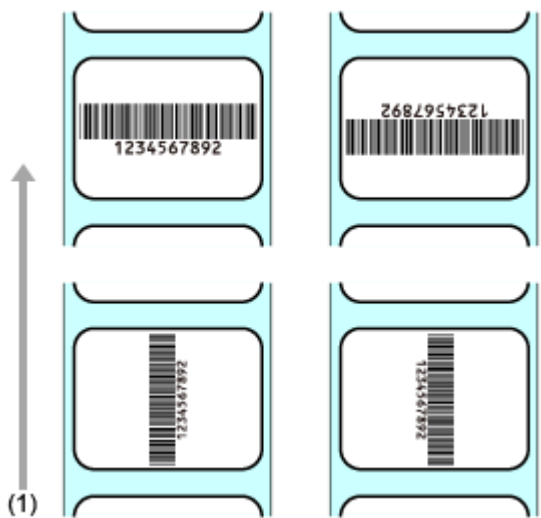
Item		Specification
	2D Code Checker	 <p>(1) Media feed direction</p> <p>Place the barcode within the size of the visual field. Do a test read carefully in advance.</p>
Recommended Barcode Sizes	1D Barcode	<p>Narrow bar: 0.25 mm (0.01") or greater</p> <ul style="list-style-type: none"> • 203 dpi: 2 dots or more • 305 dpi: 3 dots or more • 609 dpi (CL4NX Plus only): 6 dots or more <p>Refer to the specifications of each barcode checker.</p>
	2D Code	<p>Cell size: 0.25 mm (0.01") or greater</p> <ul style="list-style-type: none"> • 203 dpi: 2 dots or more • 305 dpi: 3 dots or more • 609 dpi (CL4NX Plus only): 6 dots or more <p>Refer to the specifications of each barcode checker.</p> <p>The size of the visual field conforms to the specifications of the barcode checker.</p>

Available Code Formats

The barcode check function supports the following code formats. Check the specifications of the barcode checker to ensure compatibility with the available code types.

Code Type	Available code formats
1D Barcodes	<p>CODABAR(NW-7)</p> <p>CODE39, CODE93, CODE128</p> <p>JAN/EAN-13/8</p> <p>UPC-A/UPC-E</p>

Code Type	Available code formats
	ITF Industrial 2 of 5 Matrix 2 of 5 MSI GS1-128 POSTNET IMB (USPS) GS1 DataBar Omnidirectional GS1 DataBar Truncated GS1 DataBar Limited GS1 DataBar Expanded GS1 DataBar Stacked GS1 DataBar Stacked Omnidirectional GS1 DataBar Expanded Stacked
2D Codes	PDF417 Micro PDF417 Maxi Code QR Code Micro QR Code Data Matrix Aztec Code
Combined Symbols	JAN/EAN-13/8(CC-A/CC-B) UPC-A/UPC-E(CC-A/CC-B) GS1-128(CC-A/CC-B/CC-C) GS1 DataBar(CC-A/CC-B)



- To use the comparison mode, create barcodes by using barcode commands. If a barcode such as graphic data (BMP image, etc.) or a preprinted barcode is placed within the barcode readable area, this mode may not function correctly.



- In readable mode, you can include barcodes that are not created by barcode commands (such as graphic data or preprinted barcodes) as the check target. To do this, select [Settings] in [Set No. of Barcodes], and specify the number of barcodes per label in [Barcodes per Label]. However, there may be a case that those barcodes cannot be read by scanners thus this mode does not function correctly.

Setting Up the Barcode Checker

Operational Settings for the Barcode Checker and Installation

To use the barcode check function, perform necessary operational settings for the supported barcode checker and then install it to the product.

Operational Settings for the Barcode Checker

Set up the barcode checker either by using the application software provided by its manufacturer or by reading the barcodes for setting changes printed on the barcode checker's manual. For details, refer to the manual.

- **Settings common to all supported barcode checkers**

Limit the barcode types you permit the barcode checker to read as much as possible. If a lot of barcode types are permitted, a longer decode time is required. This can cause the barcode checker to fail to read the printed barcode.

- **GFS4170, GFS4470**

- Select USB-COM. The product cannot detect the barcode checker when connected with other settings.

- **GFS4470**

- To shorten laser lighting time, it is recommended to set the reading mode to "On Line" or "Serial On Line".
- If multiple barcodes are captured at once when using the default barcode checker settings, only the first set of decoded barcode data is sent. You can change the settings to decode and send all the captured barcodes. However, if this is done, combined symbols cannot be read.
- When printing barcodes in a narrow range, allow enough time for decoding (parameter: DETM), otherwise not all of the results of the decoded captured barcodes will be sent.
- Because postal barcodes consist of bars and spaces with equal intervals, they may be read as a different barcode type. When checking postal barcodes, it is recommended to set other barcode types to be unreadable.

- **KEYENCE barcode checkers (BL-1301, SR-710)**

Set the barcode checker's interface settings to either (1) or (2).

If the barcode checker set to (1) is connected, the product will change the settings to (2).

Settings	(1)	(2)
Baud rate	9600 bps	115200 bps
Data length	7 bits	8 bits
Parity	Even	Even
Stop bit length	1 bit	1 bit

Barcode Checker Installation

Mount the barcode checker to the optional barcode checker stand kit and connect it to the product.



For details on how to install the barcode checker, refer to the Barcode Checker Stand Kit Installation Manual that came with the barcode checker stand kit.



- Because the KEYENCE barcode checkers (BL-1301, SR-710) use an RS-232C connection, an optional scanner connection cable is required.
- When replacing media or ribbon, remove the barcode checker stand kit from the product. When doing this, first turn the switch of the magnetic base stand to OFF and remove the barcode checker stand. For details on how to use the barcode checker stand, refer to the Barcode Checker Stand Kit Installation Manual.

Changing How the RS-232C Interface is Used (When Using the KEYENCE Barcode Checkers)

When using one of the KEYENCE barcode checkers (BL-1301, SR-710), modify the barcode checker's operational settings so that it can communicate with the product, and then connect it to the product. After connecting the barcode checker to the product, change the [Interface] setting of the RS-232C interface to [RS-232C Reader] on the product. With this setting, the product can detect the barcode checker and automatically connect with it according to the barcode checker's interface settings.

1. After connecting the barcode checker, press the  power button on the operator panel until the LED lights up in blue to power on the product.
2. When the product is in Online mode, press the  button on the operator panel to change to Offline mode.



3. Press the  button to show the [Settings] menu.

4. Press the ◀/▶ buttons to select [Tools], and then press the ← button.

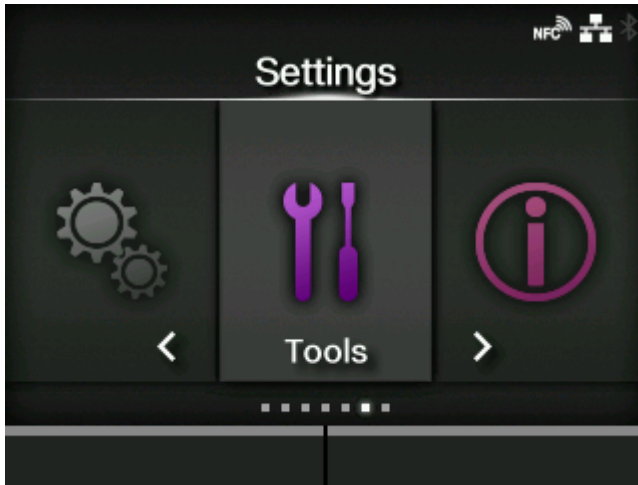

5. Press the ▲/▼ buttons to select [Barcode Checker] > [Test] > [Interface], and then press the ← button.

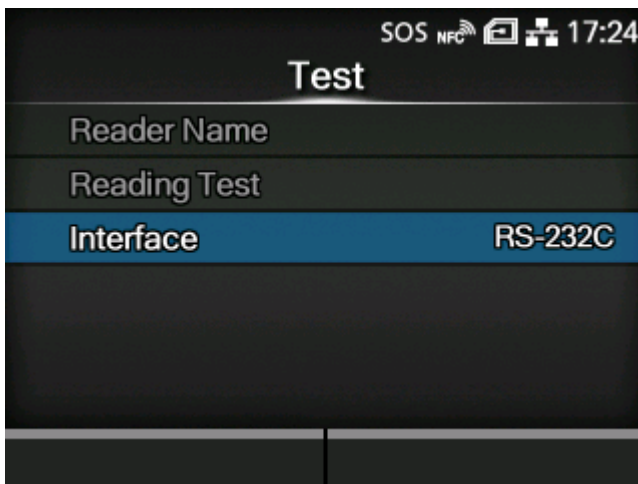

6. Press the ▲/▼ buttons to select [RS-232C Reader].

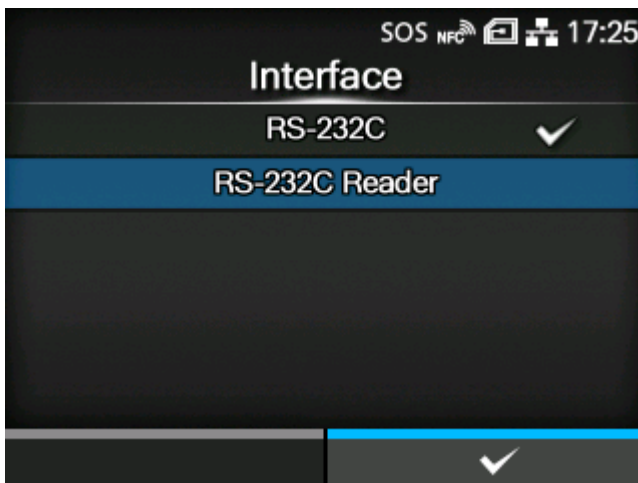

7. Press the ⏏ button to save the setting value.

8. Press the  button to change to Offline mode.

9. Power the product off, and then on again.

When the product is powered on, the barcode checker is also powered on automatically.



- When the barcode checker is powered on, it emits a laser light. Be sure to keep the laser away from your eyes.
- When using GFS4170, it keeps emitting a laser light while the product is powered on. To turn off the laser light, power off the product.

Once the connection between the product and the barcode checker is complete, the barcode checker icon appears on the status bar of the display.



Do a test read with the barcode checker to confirm that it functions correctly.



- If the product cannot detect the barcode checker, check if the operational settings of the barcode check are appropriate.

Doing a Test Read with the Barcode Checker

Prepare a label on which the barcode data you use is printed by this product.

After performing operational settings of the barcode checker and then connecting it to the product, perform a test read from the product's [Settings] menu to confirm that the barcode checker functions correctly.

1. After connecting the barcode checker, press the  power button on the operator panel until the LED lights up in blue to power on the product.

When the product is powered on, the barcode checker is also powered on automatically.

- ⚠ When the barcode checker is powered on, it emits a laser light. Be sure to keep the laser away from your eyes.
- When using GFS4170, it keeps emitting a laser light while the product is powered on. To turn off the laser light, power off the product.

Once the connection between the product and the barcode checker is complete, the barcode checker icon appears on the status bar of the display.



2. When the product is in Online mode, press the  button on the operator panel to change to Offline mode.

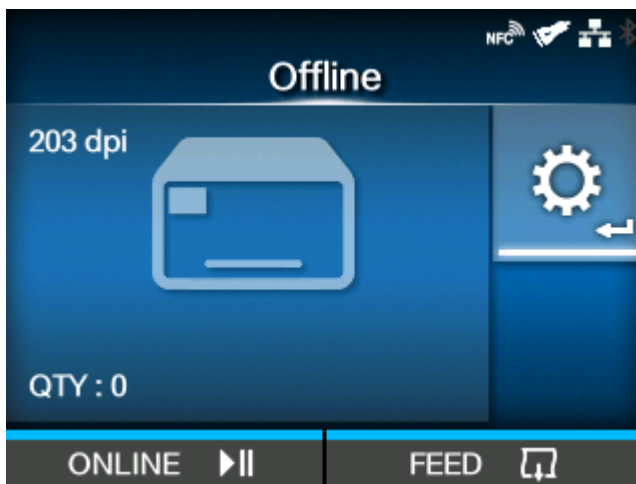

3. Press the  button to show the [Settings] menu.

4. Press the ◀/▶ buttons to select [Tools], and then press the ↩ button.

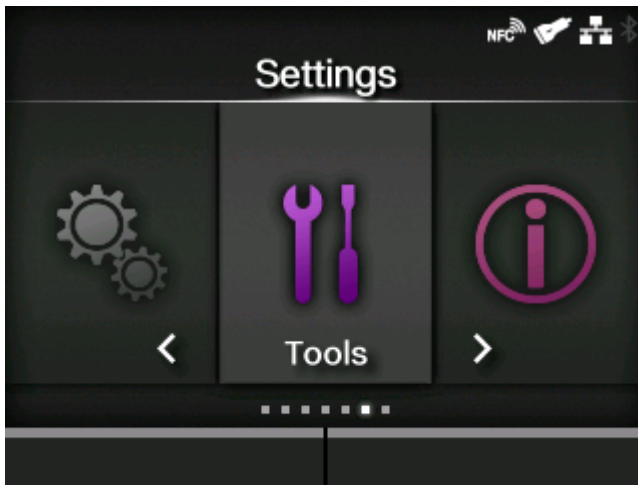

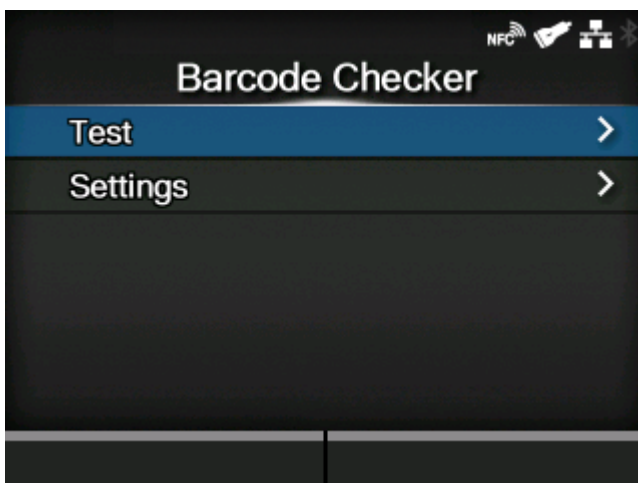

5. Press the ▲/▼ buttons to select [Barcode Checker] > [Test], and then press the ↩ button.

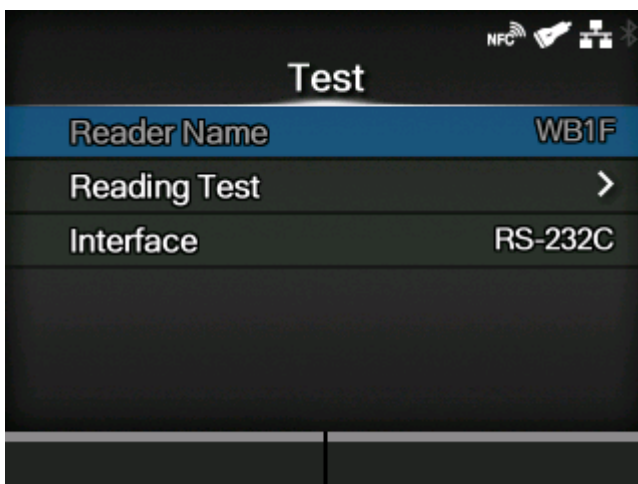

6. Confirm that the type of connected barcode checker is displayed on the right side of [Reader Name].

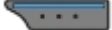

7. Press the  /  buttons to select [Reading Test], and then press the  button.
8. Set a label with barcodes within the scanning range of the barcode checker.
9. Press the  button to start reading the barcodes.

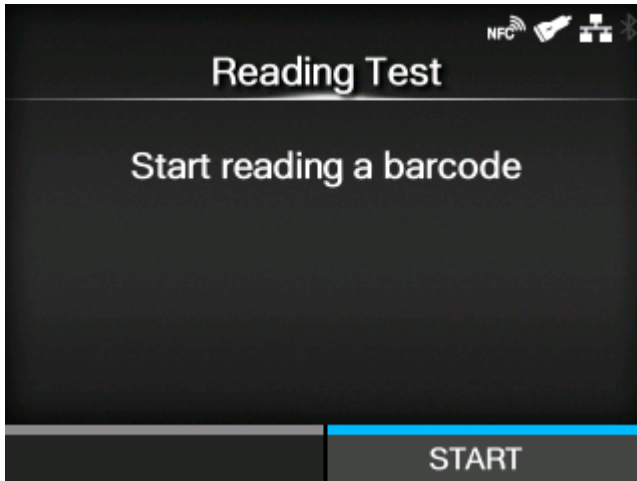

If reading is successful, the barcode type and data read are displayed on the screen. Only the first 23 bytes of data are displayed.

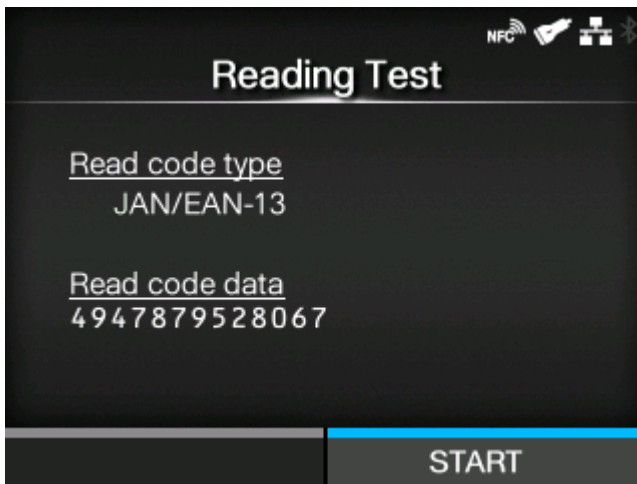

If reading is unsuccessful, or the displayed results of the read are not correct, adjust the position of the barcode checker by using the barcode checker stand. For details on how to use the barcode checker stand, refer to the Barcode Checker Stand Kit Installation Manual that came with the barcode checker stand kit.



- If the product cannot detect the barcode checker, check if the operational settings for the barcode checker are appropriate.
-

Enabling the Barcode Check

Selecting the Barcode Check Mode

The barcode check function has a readable mode and a comparison mode. You can switch the mode or disable the function from the product's [Settings] menu.

1. When the product is in Online mode, press the  button on the operator panel to change to Offline mode.

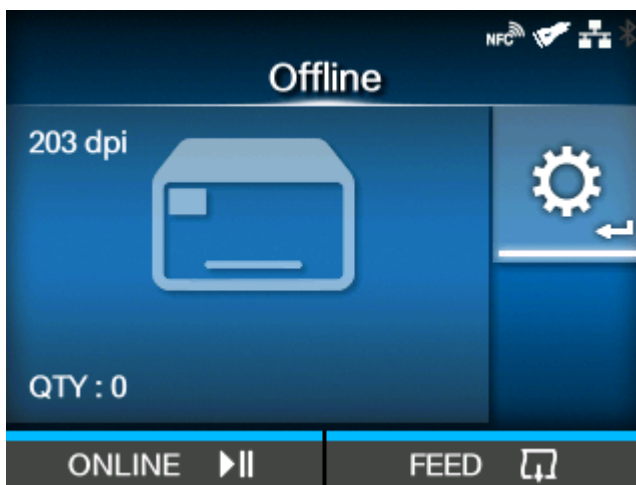

2. Press the  button to show the [Settings] menu.
3. Press the  buttons to select [Tools], and then press the  button.

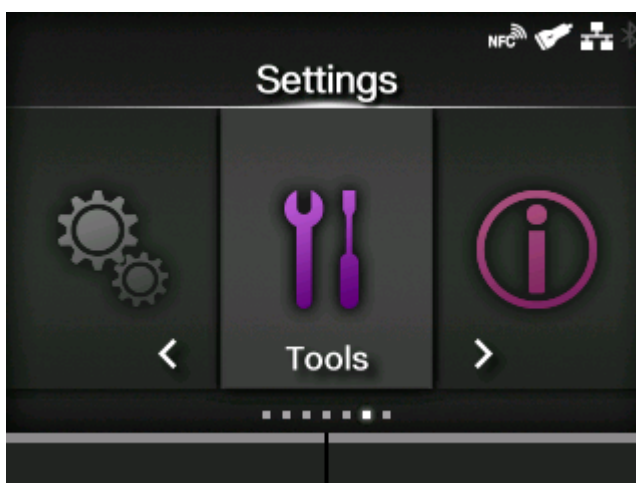

4. Press the ▲ / ▼ buttons to select [Barcode Checker] > [Settings] > [Mode], and then press the ← button.

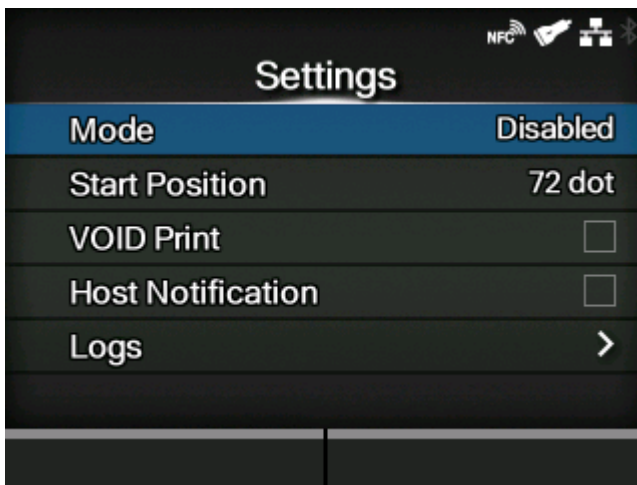

5. Press the ▲ / ▼ buttons to select the mode for the barcode check function.

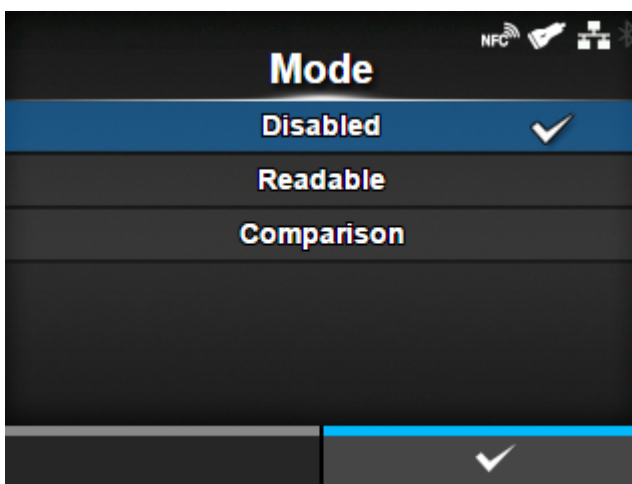

[Disabled]

Disable the barcode check function.

[Readable]

Enable readable mode.

[Comparison]

Enable comparison mode. This mode is for barcodes created by barcode commands.

6. Press the  button to save the setting value.



- When the readable mode or comparison mode is set, a barcode reader connection error occurs if the barcode checker is not connected at product startup or at the start of printing.
 - Even if the readable mode or comparison mode is set, the barcode check is not done for print data that does not include any barcode data. Normal printing is done for that data.
 - In the readable mode, to include barcodes that are not created by barcode commands (such as graphic data or preprinted barcodes) as the check target, select [Settings] in [Set No. of Barcodes], and specify the number of barcodes per label in [Barcodes per Label].
 - When [VOID Print] is enabled, you can identify a defective label by printing error marks on it.
 - The log data of barcode check results is saved on the product and can be copied to the USB memory from the [Logs] menu. By enabling [Host Notification], you can also return check results to the host from which the print data is sent.
-

Contents of the Check for Readable Mode and Comparison Mode

The barcode check function has readable mode and comparison mode. The contents of the check for each mode are as follows.



- You can check multiple barcodes on one label. Though the number of barcodes on one label is not limited, a reading error occurs when the total size of the barcode data exceeds 200 Kb.
 - In the readable mode, you can include barcodes that are not created by barcode commands (such as graphic data or preprinted barcodes) as the check target, but you need to specify the number of barcodes per label in advance. Select [Settings] in [Set No. of Barcodes], and specify the number of barcodes per label in [Barcodes per Label].
 - Reading of barcodes starts after the label length specified in [Start Position] passes. In modes where the product backfeeds before printing, the product backfeeds first, and then feeds the length of the start position.
-

Readable mode

This mode checks if the printed barcodes are readable. The readability is determined by whether the number of barcodes the barcode checker reads matches the number of barcodes in the print data.

- The reading is considered to be successful if the number of barcodes the barcode checker reads reaches the number of barcodes in the print data. The product prints the next label.

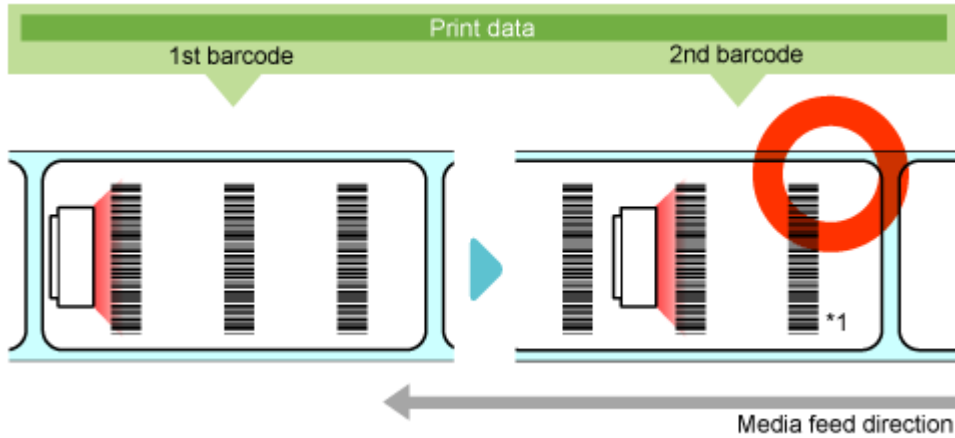

*1 Even if the number of barcodes the barcode checker reads exceeds the number of barcodes in the print data, it is considered to be successful.

- A reading error occurs if the number of barcodes in the print data is not read within the printing period from start to finish and the timeout period (up to 2 seconds).

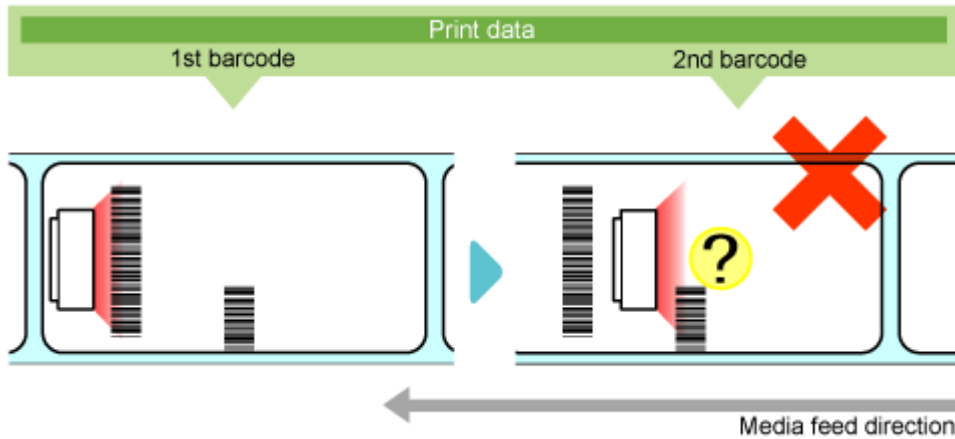

Comparison mode

This mode checks if the read results of the printed barcodes match the barcode data in the print data.

- The reading is considered to be successful if the read results of the printed barcodes match the barcode data in the print data. The product prints the next label.

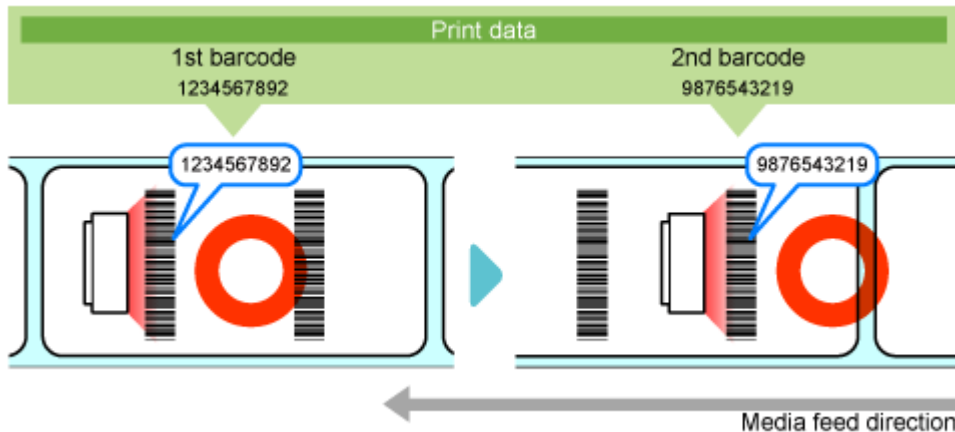

- A comparison error occurs if the read results of the printed barcodes do not match the barcode data in the print data.

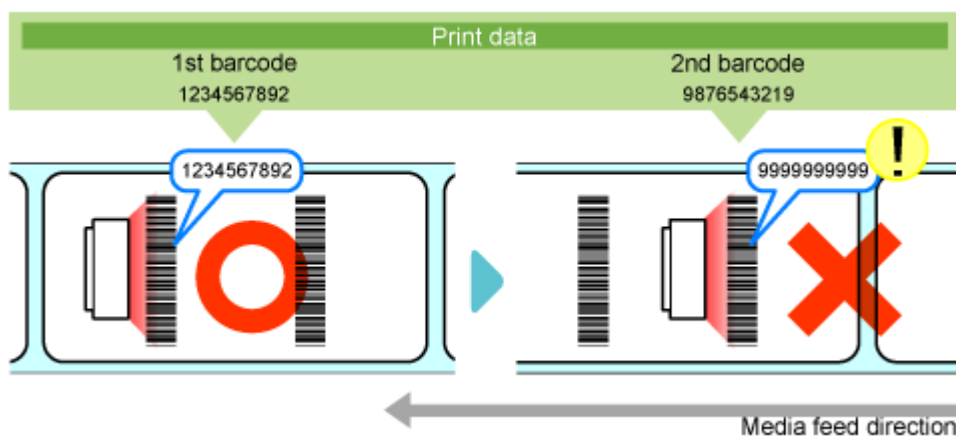

- A reading error occurs if the number of barcodes in the print data is not read within the printing period from start to finish and the timeout period (up to 2 seconds), even if the read results of the printed barcodes do not match the barcode data in the print data.

Restrictions for the Barcode Check Function

Common Restrictions for the Barcode Check Function



- When the product is powered on while the barcode checker is connected, the barcode checker is also powered on and emits a laser light. Be sure to keep the laser away from your eyes.

- The reading accuracy of barcodes or 2D codes is affected by label conditions (label curl, print quality, etc.) and the usage environment (ambient light, temperature, humidity, etc.), and readability is not guaranteed. Be sure to do a test read with the barcode checker you will use in advance.
- The types of paper that can be used are the same as the product specifications. If the label color is silver or laminated, however, it makes it difficult for the barcode checker to read the barcode, as the light of the barcode checker may cause a reflection on the label surface. Be sure to do a test read carefully in advance.
- Design the label layout so that barcodes or 2D codes do not remain within the scanning range of the barcode checker at the completion of printing. If the barcode of the previous label remains in the scanning range at the start of the next printing, the barcode checker may read the same barcode twice. The image below is when in continuous mode. As the stop position differs depending on the product's print mode and commands, be sure to check your label layout carefully in advance.

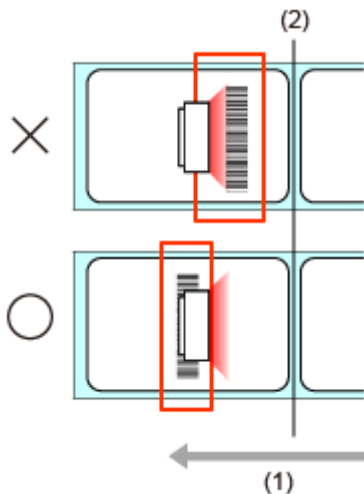

(1) Media feed direction

(2) Print head position

- Barcodes printed within the following range from the print end position cannot be read and a reading error inevitably occurs. As the following table is only for a reference, be sure to do a test read carefully in advance.

Print modes	Ranges to be avoided
Continuous	Approximately 11 mm (0.43") from the print end position
Cutter	Cutting every label Approximately 25 mm (0.98") from the print end position

Print modes	Ranges to be avoided
	Cutting according to the specified number of labels Approximately 44 mm (1.73") from the print end position
Cut & Print	Approximately 44 mm (1.73") from the print end position
Dispenser	No restriction
Linerless (CL4NX Plus only)	Approximately 25 mm (0.98") from the print end position

- The barcode check is not performed if the position at which the check starts is detected after the label feeding begins to stop. Define the label layout and position at which the check starts by keeping in mind that the distance required for stopping is proportional to the print speed.
- Printed barcodes or 2D codes can be read only with a size at which their entire pattern is within the scanning range of the barcode checker. A reading error may occur depending on the print position.
- This function cannot be controlled through the use of external signals (EXT).
- The barcode check function for GS1-128 barcodes is supported by the 1.10.0 version firmware build or later. When using GS1-128, configure the barcode checker to enable the data output format for GS1-128. When CODE128 and GS1-128 are used together with a BL-1301 barcode checker, do the settings in each setting bank. At that time, assign to GS1-128 a number that is smaller than the setting bank of CODE128.
- When powering on the product, do not connect or disconnect the barcode checker. The product may not operate properly.
- Setting the decoding number for BL-1301 and WB1F-100S1S barcode checkers cannot be done from the product by the 1.10.0 version firmware build or later. If a barcode reading error occurs, change the count settings for reading (BL-1301: Decode match count / WB1F-100S1S: Verify count). Also, when using the optional barcode checker stand kit, exclude barcode types other than those to be checked. If any barcode type other than those to be checked is set, a decreased reading speed or misreading other barcode types may occur.
- The barcode data that can be read for 1 item is up to 200 bytes per barcode and up to 200 Kb in total.

Restrictions When Using GF4170

- It keeps emitting a laser light while the product is powered on. To turn off the laser light, power off the product.

Restrictions When Using GFS4470

- By the double-reading prevention function, the barcode checker may not read barcodes that are printed successively if they are within the readable area. Adjust the print position so that same barcodes are not within the readable area.
- When printing composite symbols that use GS1 DataBar, the read data and print data never match if the barcode data is 16 digits or less. A comparison error occurs in comparison mode.
- Though "\" (0x5C) specified in MAXI code, print data should be read as "\" in the specifications. However, it may not be read as such, depending on the following data. For example, "\A" specified in print data should be read as "\A" in the specifications, but it is actually read as only "A".

Restrictions When Using WB1F-100S1S

- Multiple barcodes cannot be read at the same time.
- When NUL (0x00) is included in CODE128 print data, only the data before NUL is recognized as reading data, and NUL and the data after NUL are ignored. A comparison error occurs in comparison mode. In readable mode, a reading error occurs only if NUL is specified at the beginning of the print data.

Initializing the Product

Procedures for Initializing

Initializing the Data Saved on the Product

Initialize the data saved on the product.

The data to be initialized are the fonts and graphics registered in the product.



- It is generally not necessary to perform the initialization. Doing so could change the print conditions.
-

1. Press the  button in Online mode.



The product changes to Offline mode.

2. Press the  button.



The product changes to Settings mode.

3. Select [Tools] using the  /  buttons.

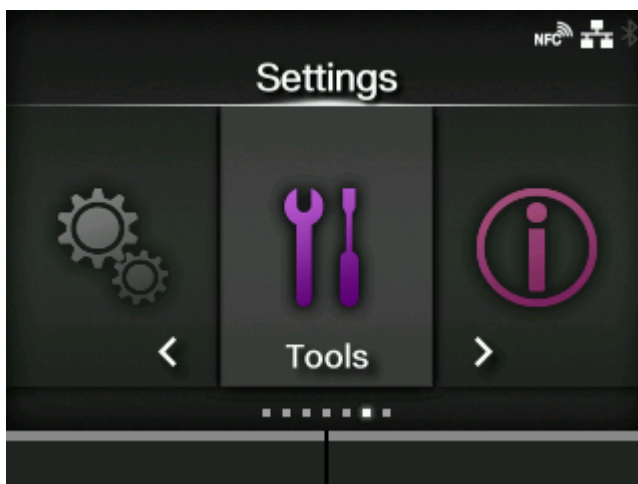

4. Press the  button.

The item list appears.

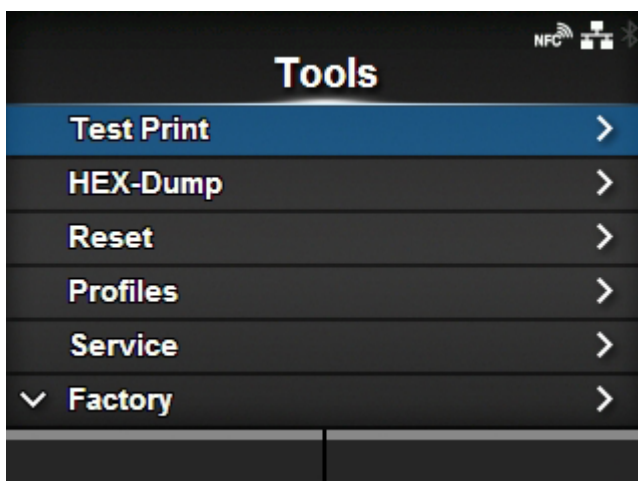

5. Select [Reset] using the ▲ / ▼ buttons.

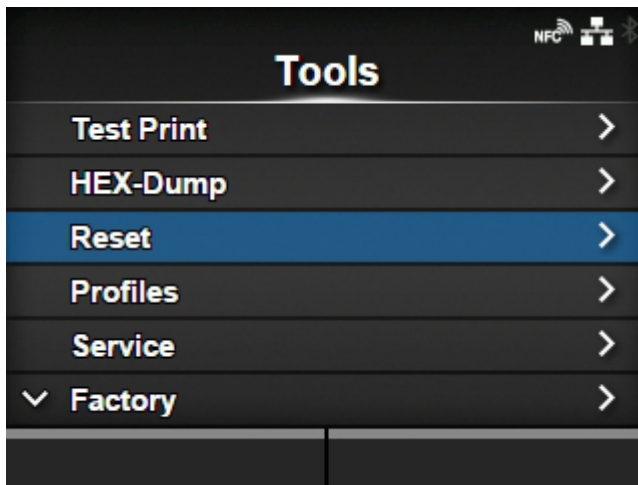

6. Press the ← button.

The [Select] screen appears.

7. Select [Data] using the ▲ / ▼ buttons.

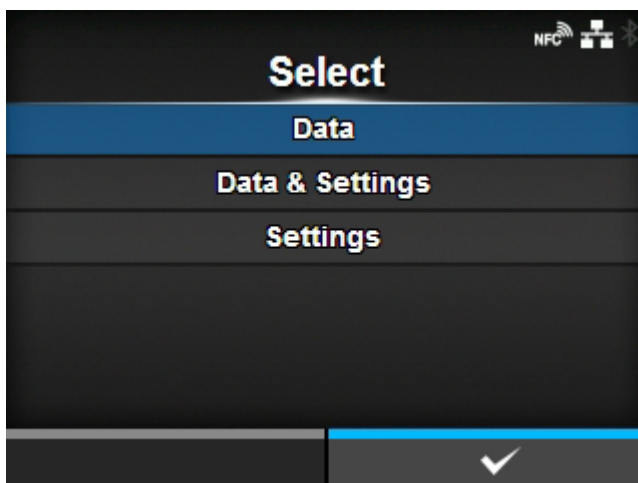

8. Press the button.

The confirmation screen appears.

9. Press the  button to perform the initialization.

Press the  button to cancel the initialization.

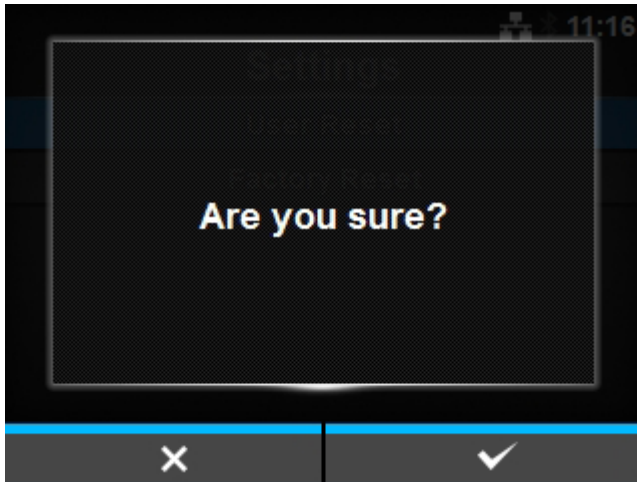

The initialization is performed.

When the initialization is complete, the product reboots.

Initializing the Setting Values and Data on the Product

Initialize the data and setting values on the product.

-
-  • It is generally not necessary to perform the initialization. Doing so could change the print conditions.
 - The data to be initialized are the fonts and graphics registered in the product.
-

1. Press the  button in Online mode.



The product changes to Offline mode.

2. Press the  button.



The product changes to Settings mode.

3. Select [Tools] using the  /  buttons.

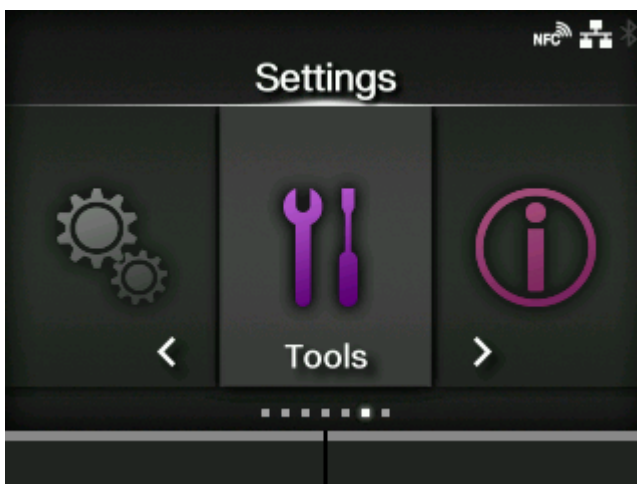

4. Press the  button.

The item list appears.

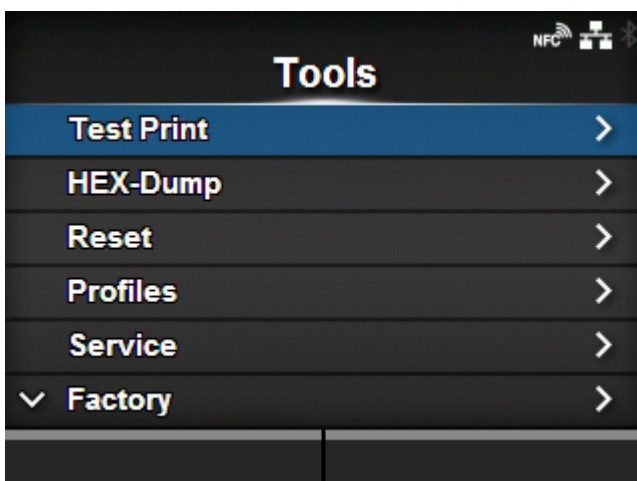

5. Select [Reset] using the ▲ / ▼ buttons.

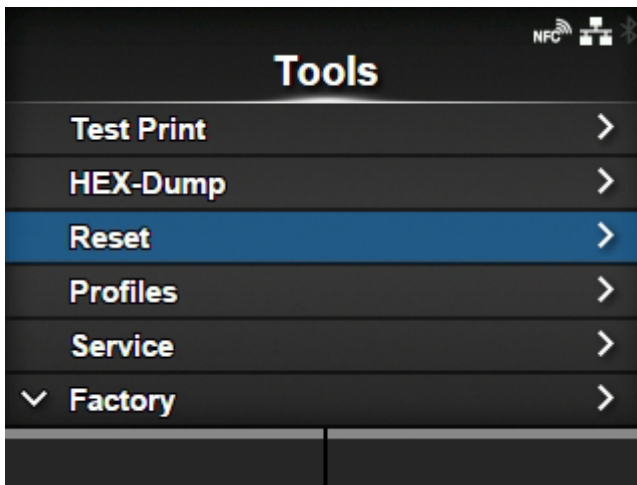

6. Press the ← button.

The [Select] screen appears.

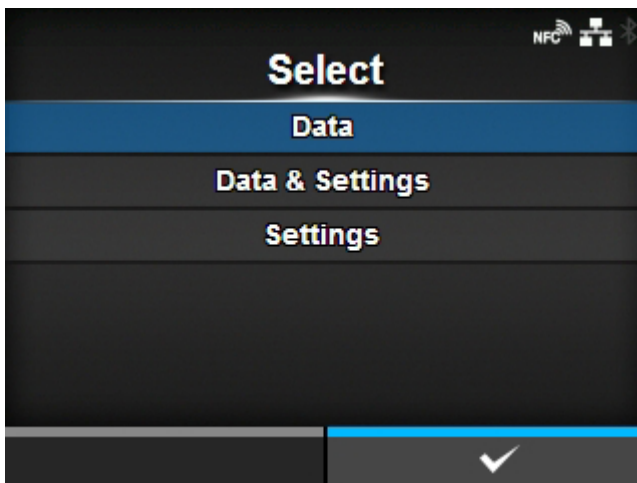

7. Select [Data & Settings] using the ▲ / ▼ buttons.

8. Press the ☰ button.

The item list appears.

9. Select the setting items to be initialized using the ▲ / ▼ buttons.

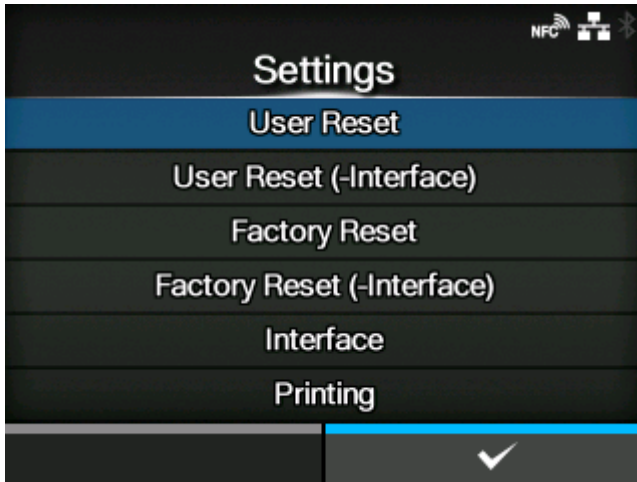

[User Reset]

Initialize the data and setting values.

[User Reset (-Interface)]

Initialize the data and setting values that are not included in the [Interface] menu.

[Factory Reset]

Initialize to the status after factory shipment.

[Factory Reset (-Interface)]

Initialize the items that are not included in the [Interface] menu to the status after factory shipment.

[Interface]

Initialize the data and setting values in the [Interface] menu.

[Printing]

Initialize the data and setting values in the [Printing] menu.

10. Press the  button.

The confirmation screen appears.

11. Press the  button to perform the initialization.

Press the  button to cancel the initialization.

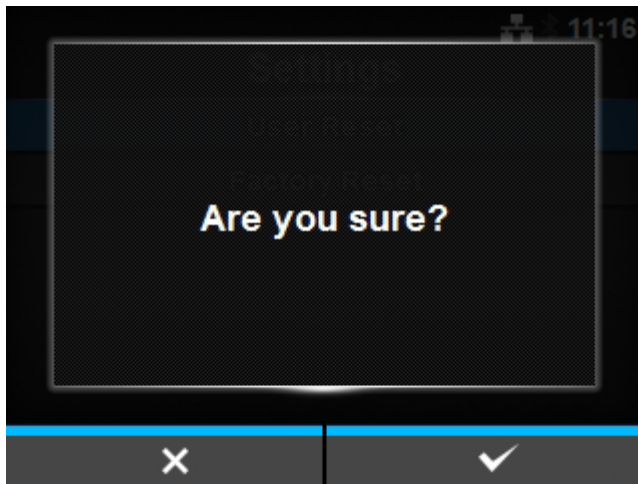

The initialization is performed.

When the initialization is complete, the product reboots.

Initializing the Setting Values on the Product

Initialize the setting values on the product.



- It is generally not necessary to perform the initialization. Doing so could change the print conditions.

1. Press the  button in Online mode.



The product changes to Offline mode.

2. Press the  button.



The product changes to Settings mode.

3. Select [Tools] using the  /  buttons.

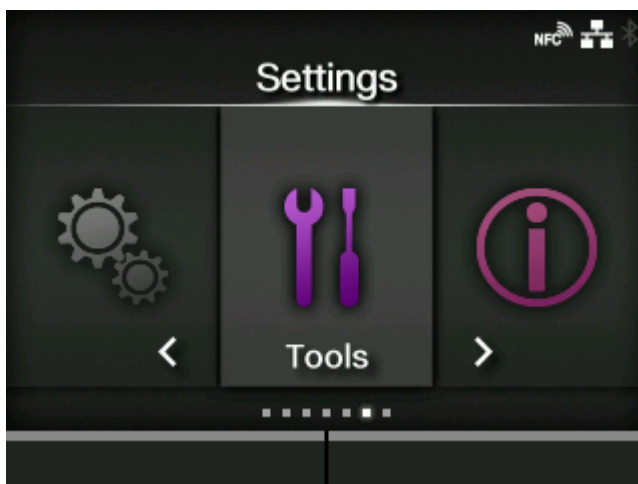

4. Press the  button.

The item list appears.

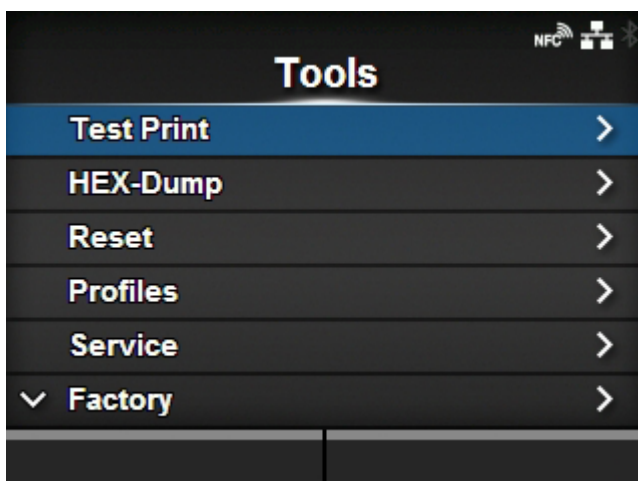

5. Select [Reset] using the ▲ / ▼ buttons.

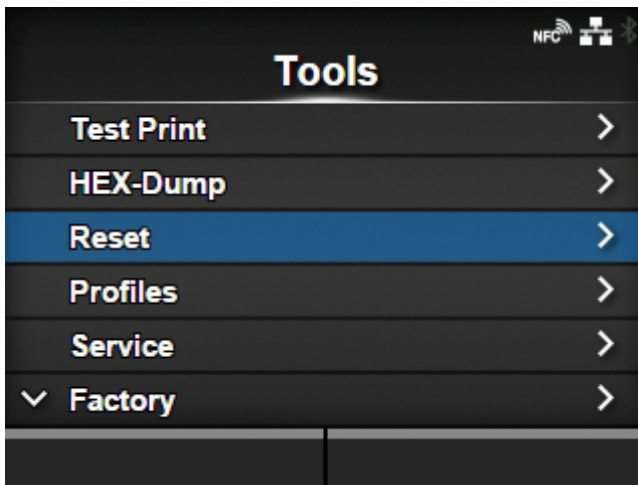

6. Press the ← button.

The [Select] screen appears.

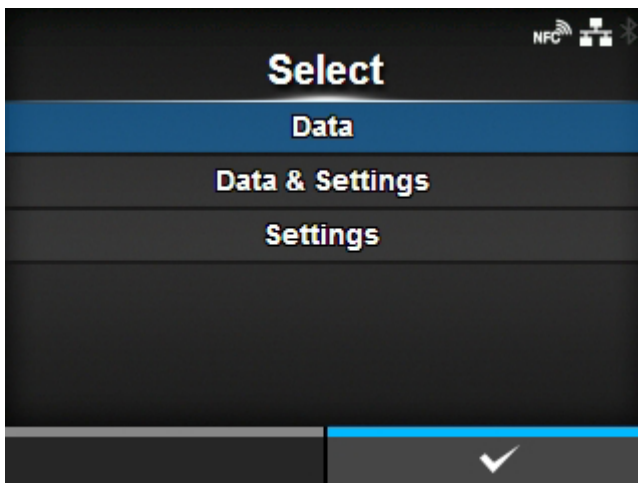

7. Select [Settings] using the ▲ / ▼ buttons.

8. Press the ☰ button.

The item list appears.

9. Select the setting items to be initialized using the ▲ / ▼ buttons.

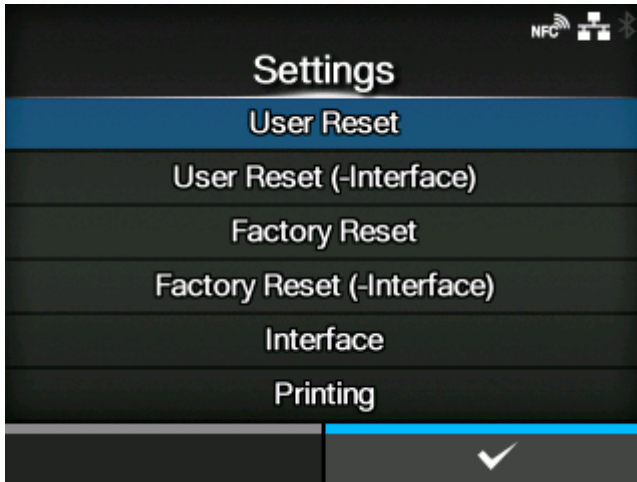

[User Reset]

Initialize the setting values.

[User Reset (-Interface)]

Initialize the setting values that are not included in the [Interface] menu.

[Factory Reset]

Initialize to the status after factory shipment.

[Factory Reset (-Interface)]

Initialize the items that are not included in the [Interface] menu to the status after factory shipment.

[Interface]

Initialize the setting values in the [Interface] menu.

[Printing]

Initialize the setting values in the [Printing] menu.

10. Press the  button.

The confirmation screen appears.

11. Press the  button to perform the initialization.

Press the  button to cancel the initialization.

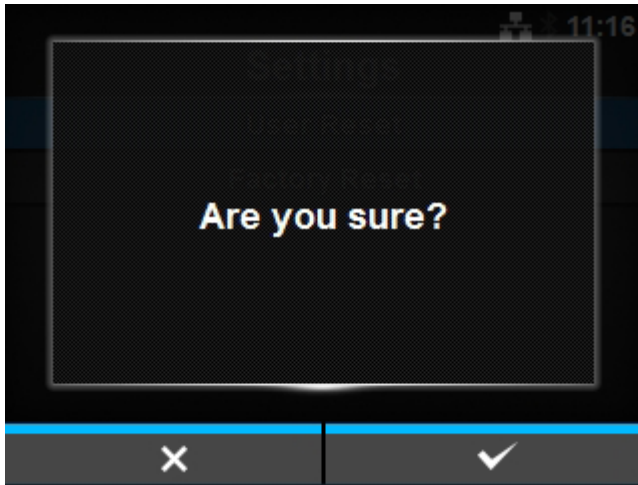

The initialization is performed.

If a message prompting you to restart the product appears on the Online/Offline screen, reboot the product to apply the settings.

List of Initial Values

[Printing] Menu

The initial value refers to the setting value of the product when it was shipped from the factory. If you reset the product, the setting values of the product will change back to the factory default values. The table below shows the initial value of each setting item and type of reset that changes the value back to the initial value.



- Normally, it is not necessary to perform the initialization. Doing an initialization removes all the product's settings that the customer changed.

Setting Item	Initial Value		User Reset	Factory Reset
	CL4NX Plus	CL6NX Plus		
[Label Length]	203 dpi 20000 dots 305 dpi 18000 dots 609 dpi 9600 dots	203 dpi 20000 dots 305 dpi 18000 dots	Yes	Yes
[Label Width]	203 dpi 832 dots 305 dpi 1248 dots 609 dpi 2496 dots	If [Head Base Position] is [Standard] 203 dpi 1216 dots 305 dpi 1984 dots If [Head Base Position] is [Left-justify] 203 dpi 1340 dots 305 dpi 2010 dots	Yes	Yes
[Auto Measure]	Disabled		Yes	Yes
[Printing Mode]	Use Ribbon		Yes	Yes
[Ribbon Near End]	Enabled		Yes	Yes

Setting Item	Initial Value		User Reset	Factory Reset
	CL4NX Plus	CL6NX Plus		
[Speed]	203 dpi 6 ips 305 dpi 6 ips 609 dpi 4 ips Linerless mode 4 ips	203 dpi 6 ips 305 dpi 6 ips	Yes	Yes
[Sensor Type]	Gap None (When [Print Mode] is [Linerless])	Gap	Yes	Yes
[Micro Label Print Mode]				
[Micro Label Print Mode]	Disable		Yes	Yes
[Auto Label Length Detection]	Enable		Yes	Yes
[Label Length Averaging Count]	3		Yes	Yes
[Label Length]	203 dpi 320 dots 305 dpi 480 dots 609 dpi 960 dots	203 dpi 320 dots 305 dpi 480 dots	Yes	Yes
[Auto-mode]	Enabled		Yes	Yes
[Print Mode]	Tear-Off (If no option is installed) Cutter (If cutter unit or rotary cutter unit is installed) Dispenser (If dispenser unit is installed) Linerless (If linerless cutter kit is installed)	Tear-Off (If no option is installed) Cutter (If cutter unit is installed) Dispenser (If dispenser unit is installed)	Yes	Yes

Setting Item	Initial Value		User Reset	Factory Reset
	CL4NX Plus	CL6NX Plus		
[Backfeed]	Before (If [Print Mode] is set to [Tear-Off] or [Linerless]) After (If [Print Mode] is set to [Dispenser], [Cutter] or [Cut & Print]) None (If [Print Mode] is set to [Continuous])	Before (If [Print Mode] is set to [Tear-Off]) After (If [Print Mode] is set to [Dispenser], [Cutter] or [Cut & Print]) None (If [Print Mode] is set to [Continuous])	Yes	Yes
[Eject Cut]	Off		Yes	Yes
[Darkness Range]	A		Yes	Yes
[Darkness]	5		Yes	Yes
[Imaging]				
[Vertical]	0 dot		Yes	Yes
[Horizontal]	0 dot		Yes	Yes
[Advanced]				
[Calibrate]				
[Auto-calibration] ¹	Gap + I-Mark		-	-
[GAP Levels]	Value adjusted by the factory.		No	No
[GAP Slice Level]	Auto		No	No
[I-Mark Levels]	Value adjusted by the factory.		No	No
[I-Mark Slice Level]	Auto		No	No
[Head Check]	Off		Yes	Yes
[Head Check Mode]	Always		Yes	Yes
[Every Page]	1		Yes	Yes
[Check Media Size]	Disabled		Yes	Yes
[Adjustments]				
[Offset]	0 dot		No	No
[Pitch]	0 dot		No	No
[Pitch Offset]	0 dot		No	No

Setting Item	Initial Value		User Reset	Factory Reset
	CL4NX Plus	CL6NX Plus		
[Darkness Adjust]	50		No	No
[Start Online]	Enabled		Yes	Yes
[Feed After Error]	Disabled		Yes	Yes
[Feed At Power On]	Disabled		Yes	Yes
[Finisher Feed]	0 dot (Standard)		Yes	Yes
[Paper End]	Using I-mark		Yes	Yes
[Head Base Position]	Standard		Yes	Yes
[Prioritize]	Commands		Yes	Yes
[Reprint]	Disabled		Yes	Yes
[Print End Position]	0 dot		Yes	Yes
[Label Near End]	Disabled		Yes	Yes

¹ Auto-calibration is not available for linerless models.

[Interface] Menu

The initial value refers to the setting value of the product when it was shipped from the factory. If you reset the product, the setting values of the product will change back to the factory default values. The table below shows the initial value of each setting item and type of reset that changes the value back to the initial value.



- Normally, it is not necessary to perform the initialization. Doing an initialization removes all the product's settings that the customer changed.

Setting Item	Initial Value		User Reset	Factory Reset
	CL4NX Plus	CL6NX Plus		
[Network]				
[Settings]				
[LAN]				
[IPv4]				
[Mode]	DHCP		Yes/ Interface	Yes/ Interface

Setting Item		Initial Value		User Reset	Factory Reset
		CL4NX Plus	CL6NX Plus		
	[DHCP]	-	-	-	-
	[IP Address]	0.0.0.0		Yes/ Interface	Yes/ Interface
	[Netmask]	255.255.255.0		Yes/ Interface	Yes/ Interface
	[Gateway]	0.0.0.0		Yes/ Interface	Yes/ Interface
	[DNS]	0.0.0.0		Yes/ Interface	Yes/ Interface
	[IPv6]				
	[Mode]	Disable		Yes/ Interface	Yes/ Interface
	[DHCP]	-		-	-
	[IP Address]	::		Yes/ Interface	Yes/ Interface
	[Prefix Length]	64		Yes/ Interface	Yes/ Interface
	[Gateway]	::		Yes/ Interface	Yes/ Interface
	[DNS]	::		Yes/ Interface	Yes/ Interface
	[Proxy]				
	[Enabled]	Disabled		Yes/ Interface	Yes/ Interface
	[Server]	-		Yes/ Interface	Yes/ Interface
	[Port No.]	-		Yes/ Interface	Yes/ Interface
	[Username]	-		Yes/ Interface	Yes/ Interface
	[Password]	-		Yes/ Interface	Yes/ Interface
	[Exclude]	-		Yes/ Interface	Yes/ Interface

Setting Item	Initial Value		User Reset	Factory Reset
	CL4NX Plus	CL6NX Plus		
[DHCP Options]				
[Update DNS (Option 81)]	Disabled		Yes/ Interface	Yes/ Interface
[Hostname]	sato-lan-<serial No.>		Yes/ Interface	Yes/ Interface
[Wi-Fi]				
[IPv4]				
[Mode]	DHCP		Yes/ Interface	Yes/ Interface
[DHCP]	-		-	-
[IP Address]	0.0.0.0		Yes/ Interface	Yes/ Interface
[Netmask]	255.255.255.0		Yes/ Interface	Yes/ Interface
[Gateway]	0.0.0.0		Yes/ Interface	Yes/ Interface
[DNS]	0.0.0.0		Yes/ Interface	Yes/ Interface
[IPv6]				
[Mode]	Disable		Yes/ Interface	Yes/ Interface
[DHCP]	-		-	-
[IP Address]	::		Yes/ Interface	Yes/ Interface
[Prefix Length]	64		Yes/ Interface	Yes/ Interface
[Gateway]	::		Yes/ Interface	Yes/ Interface
[DNS]	::		Yes/ Interface	Yes/ Interface
[Proxy]				
[Enabled]	Disabled		Yes/ Interface	Yes/ Interface

Setting Item		Initial Value		User Reset	Factory Reset
		CL4NX Plus	CL6NX Plus		
	[Server]	-		Yes/ Interface	Yes/ Interface
	[Port No.]	-		Yes/ Interface	Yes/ Interface
	[Username]	-		Yes/ Interface	Yes/ Interface
	[Password]	-		Yes/ Interface	Yes/ Interface
	[Exclude]	-		Yes/ Interface	Yes/ Interface
[DHCP Options]					
	[Update DNS (Option 81)]	Disabled		Yes/ Interface	Yes/ Interface
	[Hostname]	sato-wlan-<serial No.>		Yes/ Interface	Yes/ Interface
[Wi-Fi Protected Setup]					
	[Button (PBC)]	-		-	-
	[PIN]	-		-	-
[Wi-Fi Direct]					
	[Device Name]	SATO_PRINTER		Yes/ Interface	Yes/ Interface
	[Connect]	-		-	-
	[Start Group]	-		-	-
	[Remove Group]	-		-	-
	[Disconnect]	-		-	-
	[SSID]	DIRECT-xx-SATO_PRINTER		-	-
	[IP Address]	x.x.x.x		-	-
	[Passphrase]	xxxxxxx		-	-
	[Band]	All		Yes/ Interface	Yes/ Interface

Setting Item	Initial Value		User Reset	Factory Reset
	CL4NX Plus	CL6NX Plus		
[SSID]	SATO_PRINTER		Yes/ Interface	Yes/ Interface
[Hidden SSID]	Enabled		Yes/ Interface	Yes/ Interface
[Mode]	Ad-hoc		Yes/ Interface	Yes/ Interface
[Channel]	6		Yes/ Interface	Yes/ Interface
[Security]	None		Yes/ Interface	Yes/ Interface
[WEP Conf.]				
[Authentication]	Open System		Yes/ Interface	Yes/ Interface
[Key Index]	1		Yes/ Interface	Yes/ Interface
[Key #1]-[Key #4]	-		Yes/ Interface	Yes/ Interface
[WPA Conf.]				
[WPA Authentication]	Personal (PSK)		Yes/ Interface	Yes/ Interface
[PSK]	-		Yes/ Interface	Yes/ Interface
[EAP Conf.]	-		Yes/ Interface	Yes/ Interface
[EAP Conf.]				
[EAP Mode]	FAST		Yes/ Interface	Yes/ Interface
[Inner Method]	AUTO (When the wireless LAN module is W-LAN2 ¹ .) MSCHAPv2 (When the wireless LAN module is W-LAN ¹ .)		Yes/ Interface	Yes/ Interface
[Username]	-		Yes/ Interface	Yes/ Interface

Setting Item		Initial Value		User Reset	Factory Reset
		CL4NX Plus	CL6NX Plus		
	[Password]	-		Yes/ Interface	Yes/ Interface
	[Anon. Outer ID]	-		Yes/ Interface	Yes/ Interface
	[Verify Server Cert.]	Enabled		Yes/ Interface	Yes/ Interface
	[Private Key P/W]	-		Yes/ Interface	Yes/ Interface
	[PAC Auto Provisioning]	Disabled		Yes/ Interface	Yes/ Interface
	[PAC P/W]	-		Yes/ Interface	Yes/ Interface
	[Interface]	Auto		Yes/ Interface	Yes/ Interface
[Services]					
[Ports]					
	[Port1]	1024		Yes/ Interface	Yes/ Interface
	[Port2]	1025		Yes/ Interface	Yes/ Interface
	[Port3]	9100		Yes/ Interface	Yes/ Interface
	[Flow Control]	Status4 ENQ		Yes/ Interface	Yes/ Interface
	[TCP Connection Queue]	Enabled		Yes/ Interface	Yes/ Interface
	[Legacy Status for Port 9100]	Disabled		Yes/ Interface	Yes/ Interface
	[ENQ Reply Delay]	0 ms		Yes/ Interface	Yes/ Interface
	[Status4 Cyclic Response]	500 ms		Yes/ Interface	Yes/ Interface
	[BCC]	Disabled		Yes/ Interface	Yes/ Interface

Setting Item	Initial Value		User Reset	Factory Reset
	CL4NX Plus	CL6NX Plus		
[NTP]				
[Enable]	Disabled		No	Yes
[Error]	Disabled		No	Yes
[Time Server IP]	0.0.0.0		No	Yes
[LPD]				
[Enable]	Enabled		Yes/ Interface	Yes/ Interface
[DNS Lookup]	Disabled		Yes/ Interface	Yes/ Interface
[FTP]				
[Enable]	Disabled		Yes/ Interface	Yes/ Interface
[FTP Timeout]	300 sec		Yes/ Interface	Yes/ Interface
[SNMP]				
[sysContact]	-		Yes/ Interface	Yes/ Interface
[sysName]	-		Yes/ Interface	Yes/ Interface
[sysLocation]	-		Yes/ Interface	Yes/ Interface
[prtMarkerCounterUnit]	meters		Yes/ Interface	Yes/ Interface
[Agent]				
[Enable]	Enabled		Yes/ Interface	Yes/ Interface
[Read-Only]				
[SNMP Version]	1 2c 3		Yes/ Interface	Yes/ Interface
[Community]	public		Yes/ Interface	Yes/ Interface

Setting Item		Initial Value		User Reset	Factory Reset
		CL4NX Plus	CL6NX Plus		
	[User]	rouser		Yes/ Interface	Yes/ Interface
	[User Security]	None		Yes/ Interface	Yes/ Interface
	[Authentication Protocol]	MD5		Yes/ Interface	Yes/ Interface
	[Authentication Passphrase]	mypassword		Yes/ Interface	Yes/ Interface
	[Privacy Protocol]	DES		Yes/ Interface	Yes/ Interface
	[Privacy Passphrase]	mypassword		Yes/ Interface	Yes/ Interface
	[Read-Write]				
	[SNMP Version]	Disabled		Yes/ Interface	Yes/ Interface
	[Community]	private		Yes/ Interface	Yes/ Interface
	[User]	rwuser		Yes/ Interface	Yes/ Interface
	[User Security]	None		Yes/ Interface	Yes/ Interface
	[Authentication Protocol]	MD5		Yes/ Interface	Yes/ Interface
	[Authentication Passphrase]	mypassword		Yes/ Interface	Yes/ Interface
	[Privacy Protocol]	DES		Yes/ Interface	Yes/ Interface
	[Privacy Passphrase]	mypassword		Yes/ Interface	Yes/ Interface
	[Traps]				
	[Enable]	Disabled		Yes/ Interface	Yes/ Interface
	[SNMP Version]	1		Yes/ Interface	Yes/ Interface

Setting Item		Initial Value		User Reset	Factory Reset
		CL4NX Plus	CL6NX Plus		
	[IP Version]	4		Yes/ Interface	Yes/ Interface
	[Destinations]	1		Yes/ Interface	Yes/ Interface
	[Destination 1]	0.0.0.0		Yes/ Interface	Yes/ Interface
	[Destination 2]	0.0.0.0		Yes/ Interface	Yes/ Interface
	[Destination 3]	0.0.0.0		Yes/ Interface	Yes/ Interface
	[Community]	trapcom		Yes/ Interface	Yes/ Interface
	[User]	trapuser		Yes/ Interface	Yes/ Interface
	[Engine ID]	Hex string generated from MAC address		Yes/ Interface	Yes/ Interface
	[Security]	None		Yes/ Interface	Yes/ Interface
	[Authentication Protocol]	MD5		Yes/ Interface	Yes/ Interface
	[Authentication Passphrase]	mypassword		Yes/ Interface	Yes/ Interface
	[Privacy Protocol]	DES		Yes/ Interface	Yes/ Interface
	[Privacy Passphrase]	mypassword		Yes/ Interface	Yes/ Interface
	[Online Services]				
	[SOS Mode]	Disabled		No	No
	[Allow Remote Control]	Always		No	No
	[MQTT Protocol]	MQTT		No	No
	[Add Device]	-		-	-
	[Copy Log Files]	-		-	-
	[Contact Information]				

Setting Item		Initial Value		User Reset	Factory Reset
		CL4NX Plus	CL6NX Plus		
	[Phone Number]	-		No	No
	[Periodic Notification]				
	[Type]	Disabled		No	No
	[Counter]	Head		No	No
	[Head]				
	[Meters]	10,000		No	No
	[Last Update]	0.0 km		No	No
	[Next Update]	10.0 km		No	No
	[Current Value]	0.0 km		No	No
	[Cutter]				
	[Cuts]	100,000		No	No
	[Last Update]	0		No	No
	[Next Update]	100,000		No	No
	[Current Value]	0		No	No
	[Notifications]	1		No	No
	[Weekday]	Monday		No	No
	[Day]	1		No	No
	[Time 1]	00:00		No	No
	[Time 2]	00:00		No	No
	[Time 3]	00:00		No	No
	[Time]	00:00		No	No
	[Update Screen]	Normal		No	No
	[QR code offset]				
	[Vertical]	0		No	No
	[Horizontal]	0		No	No
	[Daily Checkup]	-		-	-

Setting Item	Initial Value		User Reset	Factory Reset
	CL4NX Plus	CL6NX Plus		
[Advanced]				
[ARP Announcement]				
[Additional]	Enabled		Yes/ Interface	Yes/ Interface
[Periodic]	Off		Yes/ Interface	Yes/ Interface
[Firewall]				
[Enable]	Disabled		Yes/ Interface	Yes/ Interface
[Allow Services And Ports]				
[Data Ports]	Enabled		Yes/ Interface	Yes/ Interface
[FTP]	Disabled		Yes/ Interface	Yes/ Interface
[LPD]	Enabled		Yes/ Interface	Yes/ Interface
[MAILC]	Enabled		Yes/ Interface	Yes/ Interface
[NTP]	Disabled		No	Yes
[Online Services]	Disabled		No	No
[PING]	Enabled		Yes/ Interface	Yes/ Interface
[SATO All-In-One Tool]	Enabled		Yes/ Interface	Yes/ Interface
[SCP]	Enabled		Yes/ Interface	Yes/ Interface
[SNMP Agent]	Enabled		Yes/ Interface	Yes/ Interface
[WEBC]	Enabled		Yes/ Interface	Yes/ Interface
[WebConfig]	Enabled		Yes/ Interface	Yes/ Interface
[Custom Settings]				

Setting Item	Initial Value		User Reset	Factory Reset
	CL4NX Plus	CL6NX Plus		
[TCP Source Port]				
	[Existing Port No.]	-	-	-
	[Additional Port No.]	-	Yes/ Interface	Yes/ Interface
[TCP Destination Port]				
	[Existing Port No.]	-	-	-
	[Additional Port No.]	-	Yes/ Interface	Yes/ Interface
[UDP Source Port]				
	[Existing Port No.]	-	-	-
	[Additional Port No.]	-	Yes/ Interface	Yes/ Interface
[UDP Destination Port]				
	[Existing Port No.]	-	-	-
	[Additional Port No.]	-	Yes/ Interface	Yes/ Interface
[ICMP Type]				
	[Existing ICMP Type]	-	-	-
	[Additional ICMP Type]	-	Yes/ Interface	Yes/ Interface
[IEEE1284]				
	[Flow Control]	Status4 Multi	Yes/ Interface	Yes/ Interface
	[BCC]	Disabled	Yes/ Interface	Yes/ Interface
[RS-232C]				
	[Baudrate]	115200	Yes/ Interface	Yes/ Interface
	[Parameters]	8-N-1	Yes/ Interface	Yes/ Interface

Setting Item	Initial Value		User Reset	Factory Reset
	CL4NX Plus	CL6NX Plus		
[Flow Control]	STATUS4		Yes/ Interface	Yes/ Interface
[BCC]	Disabled		Yes/ Interface	Yes/ Interface
[USB]				
[Flow Control]	Status4		Yes/ Interface	Yes/ Interface
[BCC]	Disabled		Yes/ Interface	Yes/ Interface
[Change USB Serial]	Disabled		No	Yes/ Interface
[Bluetooth]				
[Enable]	Enabled		Yes/ Interface	Yes/ Interface
[Name]	SATO PRINTER_XXXXXXXXXXXX (BD address)		Yes/ Interface	Yes/ Interface
[PIN Code]	0000		Yes/ Interface	Yes/ Interface
[BD Address]	XXXXXXXXXXXX		Yes/ Interface	Yes/ Interface
[Firm Version]	spp3_vX.YY		Yes/ Interface	Yes/ Interface
[Host BD Addr]	-		Yes/ Interface	Yes/ Interface
[Authentication]	None		Yes/ Interface	Yes/ Interface
[ISI]	2048		Yes/ Interface	Yes/ Interface
[ISW]	18		Yes/ Interface	Yes/ Interface
[PSI]	2048		Yes/ Interface	Yes/ Interface
[PSW]	18		Yes/ Interface	Yes/ Interface

Setting Item	Initial Value		User Reset	Factory Reset
	CL4NX Plus	CL6NX Plus		
[CRC Mode]	Disabled		Yes/ Interface	Yes/ Interface
[Flow Control]	Status4 Multi		Yes/ Interface	Yes/ Interface
[NFC]				
[I/F Enable]	Enabled		Yes/ Interface	Yes/ Interface
[Ignore CR/LF]	Disabled		Yes/ Interface	Yes/ Interface
[Ignore CAN/DLE]	Disabled		Yes/ Interface	Yes/ Interface
[External I/O]				
[Print Start Signal]	Disabled		Yes/ Interface	Yes/ Interface
[Signals]				
[EXT 9PIN]	MODE1		Yes/ Interface	Yes/ Interface
[EXT Mode]	TYPE4		Yes/ Interface	Yes/ Interface
[Inputs]				
[Start Print]	PIN 5		Yes/ Interface	Yes/ Interface
[Reprint]	PIN 7		Yes/ Interface	Yes/ Interface
[Outputs]				
[Paper End]/ [Paper/Ribbon End] (For RFID models)	PIN 1		Yes/ Interface	Yes/ Interface
[Ribbon End]/ [RFID Tag Error] (For RFID models)	PIN 3		Yes/ Interface	Yes/ Interface
[Machine Error]/ [Machine/RFID Error] (For RFID models)	PIN 4		Yes/ Interface	Yes/ Interface

Setting Item	Initial Value		User Reset	Factory Reset
	CL4NX Plus	CL6NX Plus		
[Print Done]	PIN 6		Yes/ Interface	Yes/ Interface
[Offline]/[Qty]	PIN 9		Yes/ Interface	Yes/ Interface
[Ribbon Near End]	PIN 10		Yes/ Interface	Yes/ Interface
[Dispenser]	OFF		Yes/ Interface	Yes/ Interface
[Label Near End]	OFF		Yes/ Interface	Yes/ Interface
[EXT I/O Re-print]	Disabled		Yes/ Interface	Yes/ Interface
[RFID]				
[Antenna Position]	If the RFID module is UHF Normal If SRA unit is installed and the RFID module is HF Forward	Normal	Yes/ Interface	Yes/ Interface
[Write Power]	15 dBm		Yes/ Interface	Yes/ Interface
[Read Power]	15 dBm		Yes/ Interface	Yes/ Interface
[Tag Offset]	0 mm		Yes/ Interface	Yes/ Interface
[Reader Model]	XXXXXX		-	-
[Reader Version]	XXXXXX		-	-
[PLD Version]	X.X		-	-
[View]				

Setting Item	Initial Value		User Reset	Factory Reset
	CL4NX Plus	CL6NX Plus		
[Memory Bank]	If the RFID module is UHF EPC If the RFID module is HF USER	EPC	Yes/ Interface	Yes/ Interface
[Filter Function]				
[RSSI Filter]	Disable		Yes/ Interface	Yes/ Interface
[Threshold Value]	-50 dBm		Yes/ Interface	Yes/ Interface
[Retry Mode]	Retry		Yes/ Interface	Yes/ Interface
[Retries]	1		Yes/ Interface	Yes/ Interface
[Mark bad tags]	Enabled		Yes/ Interface	Yes/ Interface
[RFID Undetected Warning]	Disable		Yes/ Interface	Yes/ Interface
[Log RFID Data]	Disabled		Yes/ Interface	Yes/ Interface
[Data To Record]	EPC and TID		Yes/ Interface	Yes/ Interface
[Output Error Mode]	Level		Yes/ Interface	Yes/ Interface
[Pulse Length]	100 ms		Yes/ Interface	Yes/ Interface
[Counters]				
[Life]				
[Count Success]	000000		No	Yes
[Count Failure]	000000		No	Yes
[Count Total]	000000		No	Yes

Setting Item	Initial Value		User Reset	Factory Reset
	CL4NX Plus	CL6NX Plus		
[User]				
[Count Success]	000000		Yes	Yes
[Count Failure]	000000		Yes	Yes
[Count Total]	000000		Yes	Yes
[Paper]				
[Types]	Label		Yes/ Interface	Yes/ Interface
[Starting Point]	0 dot		Yes/ Interface	Yes/ Interface
[SATO RF Analyze]				
[Search Start]	-		-	-
[Search Level]	Quick		Yes/ Interface	Yes/ Interface
[Write Power]	15 dBm		Yes/ Interface	Yes/ Interface
[Read Power]	15 dBm		Yes/ Interface	Yes/ Interface
[Save settings]				
[Model Name]	RFID_TAG		Yes/ Interface	Yes/ Interface
[Save]	-		-	-
[RFID Tag Model]				
[Load]	-Undefined-		Yes/ Interface	Yes/ Interface
[Edit]				
[Antenna Position]	If the RFID module is UHF Normal	Normal	Yes/ Interface	Yes/ Interface

Setting Item	Initial Value		User Reset	Factory Reset
	CL4NX Plus	CL6NX Plus		
	If the RFID module is HF Forward			
[Antenna X Pos.]	14 mm		Yes/ Interface	Yes/ Interface
[Antenna Y Pos.]	5 mm		Yes/ Interface	Yes/ Interface
[Write Power]	15 dBm		Yes/ Interface	Yes/ Interface
[Read Power]	15 dBm		Yes/ Interface	Yes/ Interface
[Tag Offset]	0 mm		Yes/ Interface	Yes/ Interface
[Pitch Size]	203 dpi 8 dots 305 dpi 12 dots 609 dpi 24 dots		Yes/ Interface	Yes/ Interface
[Save as]	RFID_TAG		Yes/ Interface	Yes/ Interface
[Delete]	-		-	-

¹ The installed wireless module is displayed in [Wi-Fi Module] in the [Information] menu.

[Applications] Menu

The initial value refers to the setting value of the product when it was shipped from the factory. If you reset the product, the setting values of the product will change back to the factory default values. The table below shows the initial value of each setting item and type of reset that changes the value back to the initial value.



- Normally, it is not necessary to perform the initialization. Doing an initialization removes all the product's settings that the customer changed.

Setting Item	Initial Value		User Reset	Factory Reset
	CL4NX Plus	CL6NX Plus		
[Protocol]	AUTO		Yes	Yes
[Auto Switch Group]				
[SBPL]	Enabled		Yes	Yes
[SZPL]	Enabled		Yes	Yes
[SIPL]	Enabled		Yes	Yes
[STCL]	Enabled		Yes	Yes
[SDPL]	Enabled		Yes	Yes
[SEPL]	Enabled		Yes	Yes
[SBPL]				
[Show Error]	Disabled RFID models: Enabled		Yes	Yes
[Standard Code]	Enabled		Yes	Yes
[Orientation]	Portrait		Yes	Yes
[Font Settings]				
[Zero Slash]	Enabled		Yes	Yes
[Kanji]				
[Kanji Set]	GB18030		Yes	Yes
[Character Code]	GB18030		Yes	Yes
[Kanji Style]	Gothic		Yes	Yes
[Proportional]	Enabled		Yes	Yes
[Code Page]	858		Yes	Yes
[€]	d5		Yes	Yes
[Compatible]				
[M-8400 Compatibility]	Disabled		Yes	Yes
[CODE128(C) Zero Fill]	Disabled		Yes	Yes
[Kanji Command]	Disabled		Yes	Yes
[Call Font/Logo]	Disabled		Yes	Yes

Setting Item	Initial Value		User Reset	Factory Reset
	CL4NX Plus	CL6NX Plus		
[A3 Command Save(S-type)]	Disabled		Yes	Yes
[PDF417 ECC Level fixed]	Disabled		Yes	Yes
[SZPL]				
[Label]				
[Shift]	0 dot		Yes	Yes
[Top]	0 dot		Yes	Yes
[Label Rotation]	0 degree		Yes	Yes
[Caret]	94 (^)		Yes	Yes
[Delimiter]	44 (,)		Yes	Yes
[Tilde]	126 (~)		Yes	Yes
[Clock Format]	(none)		Yes	Yes
[Default Font]	(none)		Yes	Yes
[SIPL]				
[Font Settings]				
[Code Page]	1252		Yes	Yes
[New Font Encoding]	Disabled		Yes	Yes
[c20 Proportional Pitch]	Disabled		Yes	Yes
[Zero Slash]	Disabled		Yes	Yes
[Format Save]	Enabled		Yes	Yes
[STCL]				
[Command Head]				
[Control Code]	Auto		Yes	Yes
[1st Byte Code]	27		Yes	Yes
[2nd Byte Code]	10		Yes	Yes
[3rd Byte Code]	0		Yes	Yes
[Font Settings]				
[Zero Slash]	Disabled		Yes	Yes

Setting Item	Initial Value		User Reset	Factory Reset
	CL4NX Plus	CL6NX Plus		
[€]	d5		Yes	Yes
[Code Page]	850		Yes	Yes
[Half-width Symbol]	Enabled		Yes	Yes
[Rotation]	0 degree		Yes	Yes
[Ignore Paper Size Command]	Disabled		Yes	Yes
[300DPI Head Compatibility]	Disabled		Yes	Yes
[SDPL]				
[Control Code]				
[Code Type]	Standard		Yes	Yes
[SOH]	01		Yes	Yes
[STX]	02		Yes	Yes
[CR]	0D		Yes	Yes
[CNTBY]	5E		Yes	Yes
[Label Rotation]	0 degree		Yes	Yes
[SOP Emulation]	Auto		Yes	Yes
[Compatible Mode]				
[TTF]	Disabled		Yes	Yes
[Graphics]	Disabled		Yes	Yes
[Compression]	Disabled		Yes	Yes
[Right-to-Left print]	Auto		Yes	Yes
[Receive TimeOut]	0 (Off)		Yes	Yes
[Blank Item Feed]	Enabled		Yes	Yes
[Prioritize]				
[Format Attribute]	Commands		Yes	Yes
[Pause Mode]	Commands		Yes	Yes
[1 Byte Codepage]	Commands		Yes	Yes
[SDPL Measure Unit]	Commands		Yes	Yes

Setting Item	Initial Value		User Reset	Factory Reset
	CL4NX Plus	CL6NX Plus		
[Scalable Font Style]	Commands		Yes	Yes
[Sensor Type]	Commands		Yes	Yes
[Feedback Character]	Commands		Yes	Yes
[SOH Commands]	Commands		Yes	Yes
[Module Selection]	Commands		No	No
[Darkness]	-		Yes	Yes
[Factory Offset]	-		Yes	Yes
[Speed]	-		Yes	Yes
[Format Attribute]	XOR		Yes	Yes
[Pause Mode]	Disabled		Yes	Yes
[1 Byte Codepage]	CP 850		Yes	Yes
[SDPL Measure Unit]	Inch		Yes	Yes
[Scalable Font Style]				
[Bold]	Disabled		Yes	Yes
[Italic]	Disabled		Yes	Yes
[Feedback Character]	Enabled		Yes	Yes
[SOH Commands]				
[All Commands]	Enabled		Yes	Yes
[SOH-B Command]	Enabled		Yes	Yes
[SOH-C Command]	Enabled		Yes	Yes
[Others]	Enabled		Yes	Yes
[Module Selection]	A		Yes	Yes
[SEPL]				
[Home Reference]				
[Horz. Offset]	0 dot		Yes	Yes
[Vert. Offset]	0 dot		Yes	Yes
[Label Rotation]	0 degree		Yes	Yes

Setting Item	Initial Value		User Reset	Factory Reset
	CL4NX Plus	CL6NX Plus		
[Memory Device]	Internal FLASH		Yes	Yes
[Sim. 300 DPI Head]	Disabled		Yes	Yes
[AEP]				
[Enable]	Disabled		No	Yes
[Starting Application]	Standard Demo		No	Yes
[Delete Application]	-		-	-
[Label Rotation]	Disabled		Yes	Yes

[System] Menu

The initial value refers to the setting value of the product when it was shipped from the factory. If you reset the product, the setting values of the product will change back to the factory default values. The table below shows the initial value of each setting item and type of reset that changes the value back to the initial value.



- Normally, it is not necessary to perform the initialization. Doing an initialization removes all the product's settings that the customer changed.

Setting Item	Initial Value		User Reset	Factory Reset
	CL4NX Plus	CL6NX Plus		
[Regional]				
[Messages]	English, US		Yes	Yes
[USB Keyboard]	English, US		Yes	Yes
[Locale]	English, US		Yes	Yes
[Unit]	dot		Yes	Yes
[Time]	00:00		No	No
[Date]	(2000-01-01)		No	No
[Time Zone]	-		Yes	Yes
[Region]	Europe		Yes	Yes
[City]	London		Yes	Yes
[Display Language Icon]	Disabled		Yes	Yes

Setting Item	Initial Value		User Reset	Factory Reset
	CL4NX Plus	CL6NX Plus		
[Notifications]				
[Clean Printhead]				
[Clean Printhead]	Disabled		Yes	Yes
[Cleaning Interval]	400 m		Yes	Yes
[Change Printhead]				
[Change Printhead]	Disabled		Yes	Yes
[Printhead Interval]	100 km		Yes	Yes
[Change Cutter]				
[Change Cutter]	Disabled		Yes	Yes
[Cutter Life]	1000 K cuts		Yes	Yes
[Change Platen]				
[Change Platen]	Disabled		Yes	Yes
[Platen Interval]	100 km		Yes	Yes
[Sound]				
[Error Sound]	Medium		Yes	Yes
[Power Off Sound]	Medium		Yes	Yes
[Energy Saving]				
[Sleep Timeout]	45 min		Yes	Yes
[LCD Brightness]	7		No	Yes
[Show Total Count]	Disabled		Yes	Yes
[Password]				
[Password Enable]	Disabled		No	Yes
[Install Security]	Disabled		No	Yes
[NFC Security]	None		Yes	Yes
[Start on AC]	Disabled		No	Yes

[Tools] Menu

The initial value refers to the setting value of the product when it was shipped from the factory. If you reset the product, the setting values of the product will change back to the factory default values. The table below shows the initial value of each setting item and type of reset that changes the value back to the initial value.



- Normally, it is not necessary to perform the initialization. Doing an initialization removes all the product's settings that the customer changed.

Setting Item	Initial Value		User Reset	Factory Reset
	CL4NX Plus	CL6NX Plus		
[Test Print]				
[Factory]				
[Label Width]	Large		Yes	Yes
[Pitch]	0 dot		No	No
[Offset]	0 dot		No	No
[Darkness Adjust]	50		No	No
[Configure List]				
[Label Width]	Small		-	-
[Label Length]	203 dpi 800 dots 305 dpi 1200 dots 609 dpi 2400 dots	203 dpi 800 dots 305 dpi 1200 dots	Yes	Yes
[Pitch]	0 dot		No	No
[Offset]	0 dot		No	No
[Darkness Adjust]	50		No	No
[Configure QR]				
[Label Width]	Small		-	-
[Label Length]	203 dpi 800 dots	203 dpi 800 dots	Yes	Yes

Setting Item	Initial Value		User Reset	Factory Reset
	CL4NX Plus	CL6NX Plus		
	305 dpi 1200 dots 609 dpi 2400 dots	305 dpi 1200 dots		
[Pitch]	0 dot		No	No
[Offset]	0 dot		No	No
[Darkness Adjust]	50		No	No
[Paper Sensor]				
[Label Width]	Small		-	-
[Label Length]	203 dpi 800 dots 305 dpi 1200 dots 609 dpi 2400 dots	203 dpi 800 dots 305 dpi 1200 dots	Yes	Yes
[Pitch]	0 dot		No	No
[Offset]	0 dot		No	No
[Darkness Adjust]	50		No	No
[Head Check]				
[Label Width]	203 dpi 832 dots 305 dpi 1248 dots 609 dpi 2496 dots	If [Head Base Position] is [Standard] 203 dpi 1216 dots 305 dpi 1984 dots If [Head Base Position] is [Left-justify] 203 dpi 1340 dots	Yes	Yes

Setting Item	Initial Value		User Reset	Factory Reset
	CL4NX Plus	CL6NX Plus		
		305 dpi 2010 dots		
[Label Length]	203 dpi 120 dots 305 dpi 180 dots 609 dpi 360 dots	203 dpi 120 dots 305 dpi 180 dots	Yes	Yes
[Pitch]	0 dot		No	No
[Offset]	0 dot		No	No
[Darkness Adjust]	50		No	No
[HEX-Dump]				
[Hex Dump Mode]	Disabled		Yes	Yes
[Reset]				
[Profiles]				
[Delete]	-		-	-
[Load]	-		-	-
[Save]	-		-	-
[Start with]	-		Yes	Yes
[Certificates]	-		Yes/ Interface	Yes
[Barcode Checker]				
[Test]				
[Reader Name]	-		-	-
[Reading Test]	-		-	-
[Interface]	RS-232C		Yes/ Interface	Yes/ Interface
[Settings]				
[Mode]	Disabled		Yes	Yes

Setting Item	Initial Value		User Reset	Factory Reset
	CL4NX Plus	CL6NX Plus		
[Set No. of Barcodes]	Command		Yes	Yes
[Barcodes per Label]	1		Yes	Yes
[Start Position]	203 dpi 72 dots 305 dpi 108 dots 609 dpi 216 dots	203 dpi 72 dots 305 dpi 108 dots	Yes	Yes
[VOID Print]	Disabled		Yes	Yes
[Retry Count]	0		Yes	Yes
[Host Notification]	Disabled		Yes	Yes
[Logs]				
	[Copy]	-	-	-
	[Remove]	-	-	-
[Clone]	Excl. LAN/Wi-Fi/IP/Bluetooth		-	-
[Support Info]	-		-	-
[Logging Function]				
[Enabled]	Disabled		Yes	Yes
[Save]	-		-	-
[Remove]	-		-	-
[Startup Guide]	Enabled		No	Yes

[Information] Menu

The initial value refers to the setting value of the product when it was shipped from the factory. If you reset the product, the setting values of the product will change back to the factory default values. The table below shows the initial value of each setting item and type of reset that changes the value back to the initial value.



- Normally, it is not necessary to perform the initialization. Doing an initialization removes all the product's settings that the customer changed.

Setting Item	Initial Value		User Reset	Factory Reset
	CL4NX Plus	CL6NX Plus		
[Help]	-	-	-	-
[Build Version]	-	-	-	-
[Applications]	-	-	-	-
[Installation Log]	-	-	-	-
[Print Module]	-	-	-	-
[FPGA Version]	-	-	-	-
[Counters]	-	-	-	-
[Head]	-	-	-	-
[Life]	Measured value		No	No
[Head 1]	Measured value		No	No
[Head 2]	Measured value		No	No
[Head 3]	Measured value		No	No
[Cutter]	0		No	No
[IPv4 Address]	0.0.0.0		-	-
[IPv6 Address]	0:0:0:0:0:0:0:0		-	-

Maintenance

Cleaning the Product

Cleaning

A dirty print head or platen roller not only affects the print quality but also causes errors and malfunctions. Clean the product periodically to keep it running reliably.



- Do not power on or off the product, connect or disconnect the power cord while your hands are wet. Doing so could cause an electric shock.
-



- Disconnect the power cord from the AC outlet before you begin cleaning.
The print head and its surroundings are hot after printing. Wait until the product cools down.
 - Touching the edge of the print head with your bare hand could cause injury.
 - Be careful not to touch the cutter blade when cleaning the product.
 - Use our recommended cleaning products for cleaning. Do not clean with a hard object. Doing so could cause damage.
 - Remove the media and ribbon before cleaning.
-



CAUTION for CL4NX Plus only (if installed with linerless cutter kit)

- Open the print head and remove linerless labels from the platen roller if they are not used for printing for a long period. Paper jam might occur if the print head is closed for a long period with linerless labels loaded.
 - When loading linerless label, make sure that the front end of the media extends about 3 cm (1.18") out the media discharge outlet.
-



- Contact your SATO reseller or technical support to purchase the cleaning kit, cleaning sheets, and other of our cleaning products.
-

Cleaning Intervals

Clean the product at the following regular intervals.



- The below cleaning intervals are only for reference. Clean the product when necessary even if you are not at a regular interval.
-

- After you print one media roll or print media for 150 meters (492.1 feet).

Use the cleaning kit to clean following parts:

- Print head
- Platen roller
- Media sensors
- Media guide

- After you print six media rolls or print media for 900 meters (2952.8 feet).

Use the cleaning sheet to clean the following parts:

- Print head

Use the cleaning kit to clean following parts:

- Media route
- Ribbon route

Cleaning interval for the optional linerless cutter kit (CL4NX Plus only) is as follows:

- After you print one media roll or whenever there is any glue residue or paper dust on the media route.

Use the cleaning kit to clean following parts:

- Print head
- Media guide
- Media sensors
- Guide rollers
- Linerless platen roller

Cleaning Using the Cleaning Kit

The cleaning procedure using the cleaning kit is as follows:



- Never use organic solvents, such as thinner and benzine to clean the product.
-



- For details on the cleaning kit, refer to the manual attached to the cleaning kit.
-

1. Make sure that the product is powered off, and disconnect the power cord from the AC outlet.

2. Open the top cover.



- Open the top cover fully to prevent accidental drop of the cover.
-

3. Push the head lock lever (1) towards the rear to unlock the print head.



- The print head and its surroundings are hot after printing. Be careful not to get burned.
 - Touching the edge of the print head with your bare hand could cause injury.
-

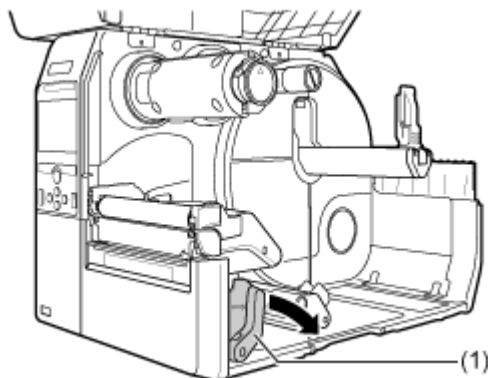

4. Remove the media and ribbon if they are already loaded.

5. Clean the dirt on the print head (2), platen roller (3) and ribbon roller (4) using a cotton swab dabbed with cleaning liquid.

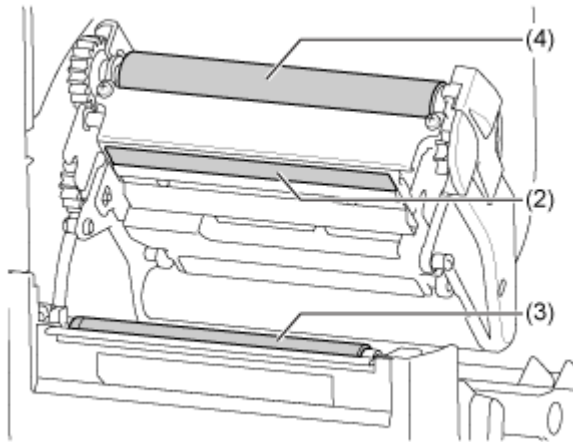

6. Tilt the sensor guide lock (5) down and pull out the media sensor guide (6).

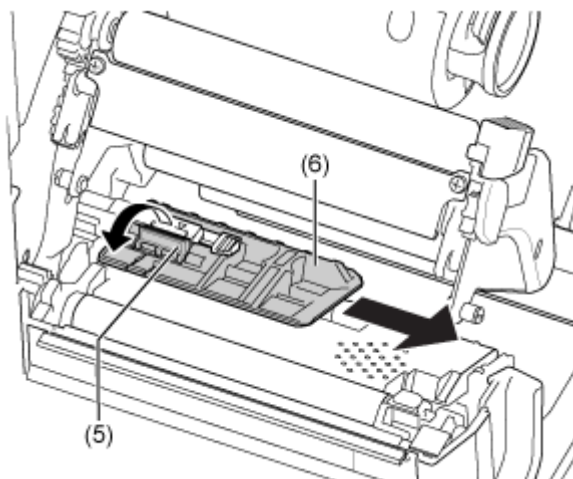

7. Clean the bottom of the media sensor guide using the cotton cloth dabbed with cleaning liquid.

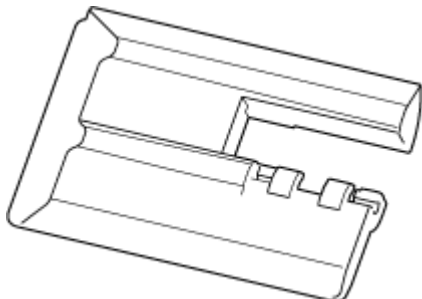

8. Clean the media sensor (7) using the cotton cloth dabbed with cleaning liquid.

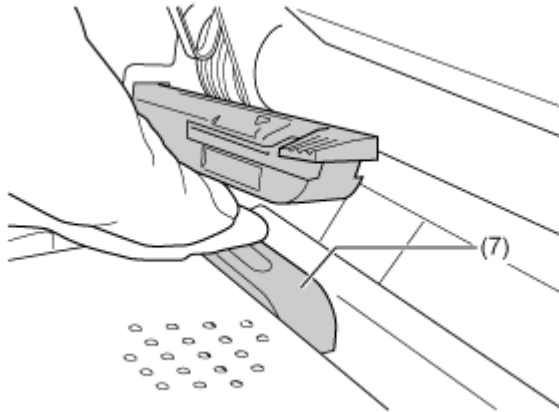

9. Return the media sensor guide to its original position and tilt the sensor guide lock up to the locked position.

Cleaning the Optional Linerless Cutter Kit (CL4NX Plus Only)

If the optional linerless cutter kit is installed, follow the procedure below to clean the product:

1. Clean the media guide (1) and inner surface (2) that is in contact to the label edge using the cotton cloth dabbed with cleaning liquid.

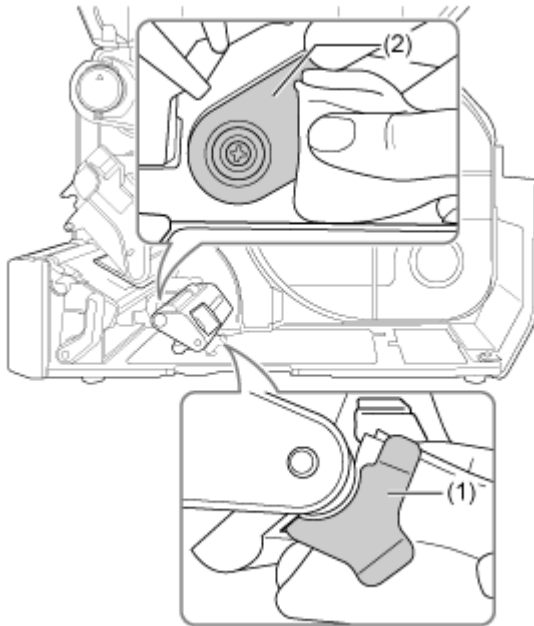

2. Clean the guide rollers (3) using the cotton cloth dabbed with cleaning liquid.

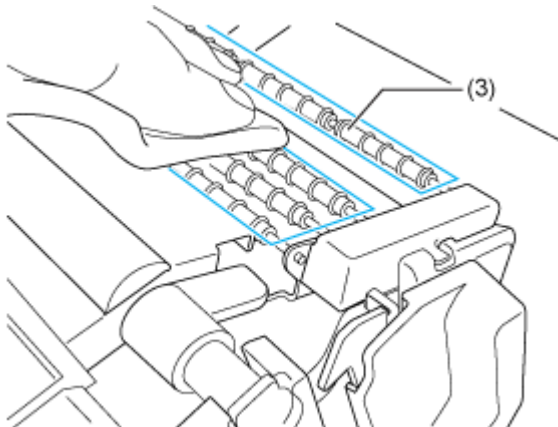

Rotate the guide rollers to clean the whole areas of them.

Cleaning Using the Cleaning Sheet

The cleaning procedure using the cleaning sheet is as follows:

1. **Make sure that the product is powered off, and disconnect the power cord from the AC outlet.**
2. **Open the top cover.**



- Open the top cover fully to prevent accidental drop of the cover.
-

3. **Push the head lock lever (1) towards the rear to unlock the print head.**



- The print head and its surroundings are hot after printing. Be careful not to get burned.
 - Touching the edge of the print head with your bare hand could cause injury.
-

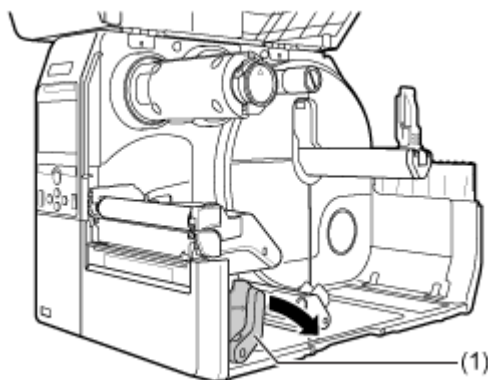

4. **Remove the media and ribbon if they are already loaded.**
5. **Place the cleaning sheet (2) between the print head and the platen roller.**



- Align the rough side of the cleaning sheet adjacent to the print head.

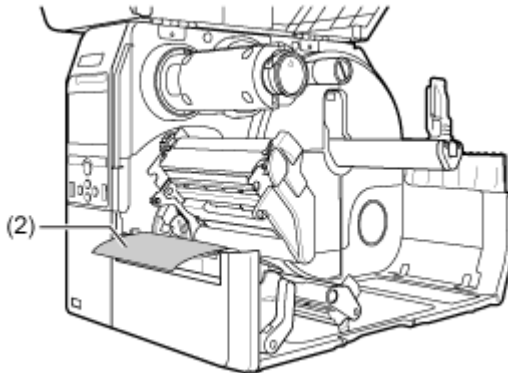

6. Press the print head down until you lock the head lock lever in place.

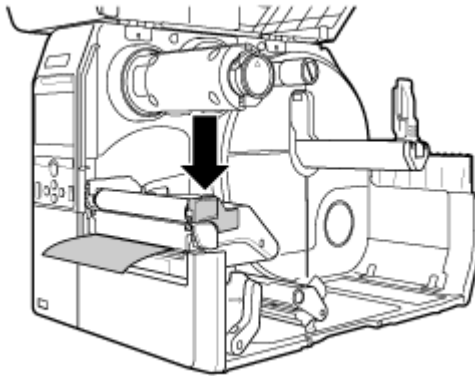

7. Using two hands, pull the cleaning sheet away from the product.

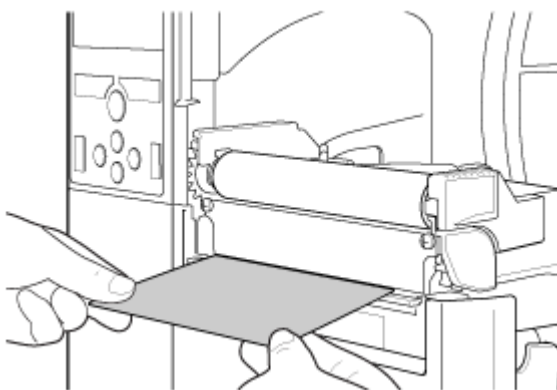

8. After you pull out the cleaning sheet, repeat steps 5 through 7, two or three more times.

When no more dirt appears on the cleaning sheet after you have pulled it out, stop repeating these steps.

9. Push the head lock lever (1) towards the rear to unlock the print head.

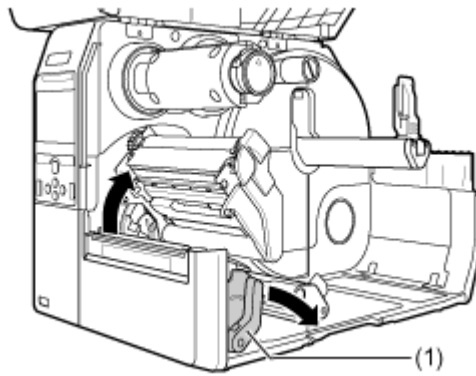

10. Use a cotton swab to clean the dirt on the print head (3).

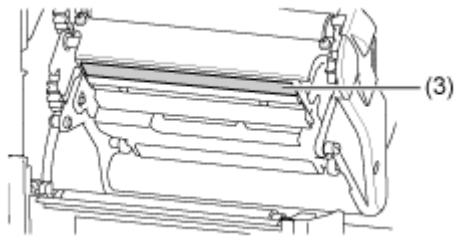

Replacing Consumable Parts

Replacing the Print Head

You can easily remove and replace a damaged or worn print head.



- Do not power on or off the product, connect or disconnect the power cord while your hands are wet. Doing so could cause an electric shock.
 - Disconnect the power cord from the AC outlet before you replace the print head.
 - Wear gloves before replacing the print head, to prevent damage to the print head.
-

1. Make sure that the product is powered off, and disconnect the power cord from the AC outlet.

2. Open the top cover.



- Open the top cover fully to prevent accidental drop of the cover.
-

3. Push the head lock lever (1) towards the rear to unlock the print head.



- The print head and its surroundings are hot after printing. Wait until the product cools down.
 - Touching the edge of the print head with your bare hand could cause injury.
-

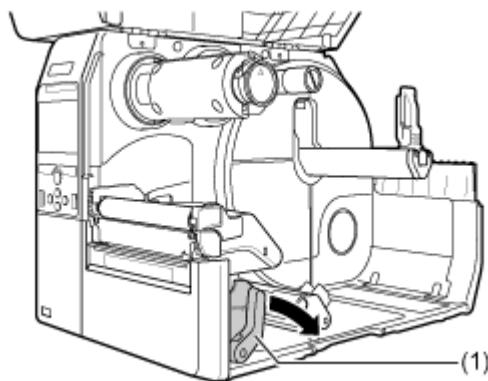

4. Remove the media and ribbon if they are already loaded.

5. Press the lever (2) to remove the print head (3).

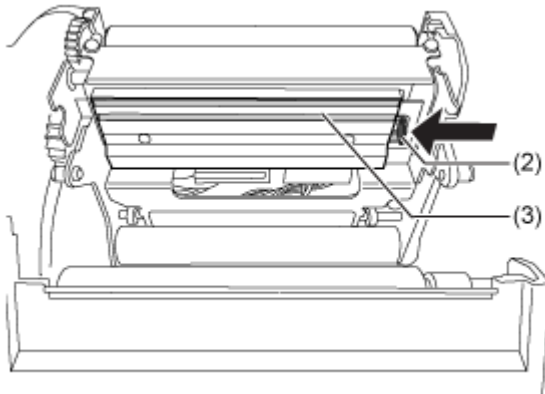

- For UHF RFID models, the UHF RFID antenna is installed on the print head. Be careful not to overly pull the antenna cable when replacing the print head. Contact your SATO reseller, dealer, or technical support center for more information.

6. Disconnect all the connectors (4) from the defective print head (3).

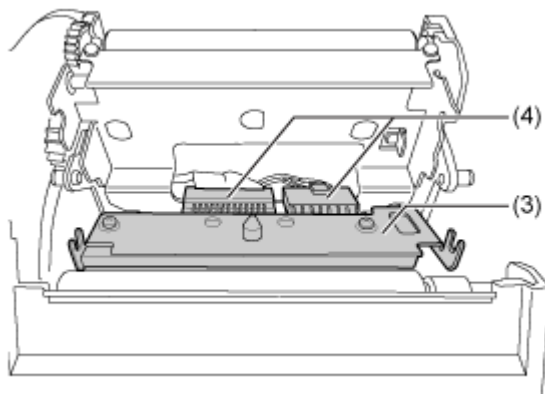

In total, there are two connectors for CL4NX Plus and three connectors for CL6NX Plus.

7. Connect all the connectors (4) to the new print head.



- Handle the print head with care. Do not contaminate or scratch the sensitive print head surface.

8. Install the new print head.

Install the print head so that it is locked with a click sound.

9. Load the media and ribbon back if you remove them in step 4.

Replacing the Platen Roller

You can easily remove and replace a damaged or worn platen roller.

-
- ⚠ • Do not power on or off the product, connect or disconnect the power cord while your hands are wet. Doing so could cause an electric shock.
 - Disconnect the power cord from the AC outlet before you replace the platen roller.
-

Guideline to Replace the Platen Roller

The platen roller has a striped marking on the left side. When the striped marking started to fade off, it indicates that you should replace the platen roller.



-
- ⚠ • This is only a general guideline. The condition in which the platen roller wears out varies depending on the used media. In any cases, replace the worn platen roller when it affected the printing quality of the product.
-

1. **Make sure that the product is powered off, and disconnect the power cord from the AC outlet.**
2. **Open the top cover.**

-
- ⚠ • Open the top cover fully to prevent accidental drop of the cover.
-

3. **Push the head lock lever (1) towards the rear to unlock the print head.**

-
- ⚠ • The print head and its surroundings are hot after printing. Be careful not to get burned.
 - Touching the edge of the print head with your bare hand could cause injury.
-

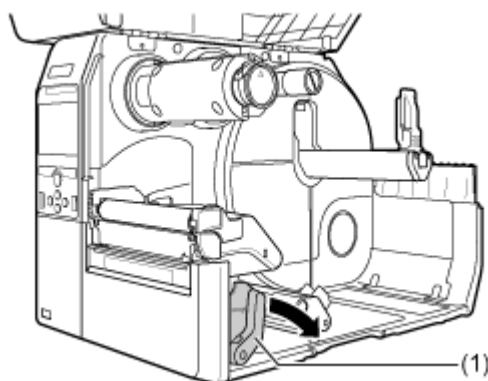

4. Lift the lever (2) in the direction A to unlock the platen roller (3), and then pull out the platen roller (3) in the direction B.

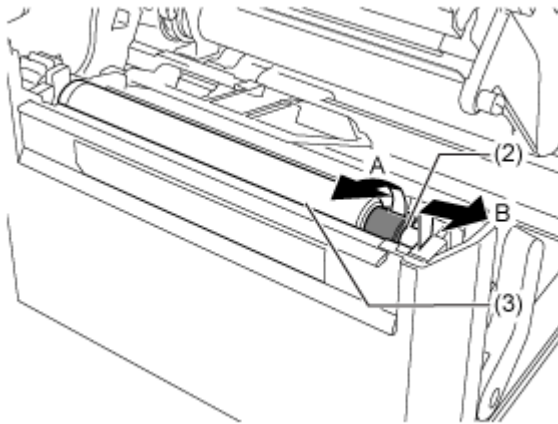

5. Install the new platen roller.

- a. Make sure that the tab (4) on the left driving end of the platen roller is pointing upward. Push the platen roller in the direction C so that the tab (4) is fixed in the groove (5) at the driving side.

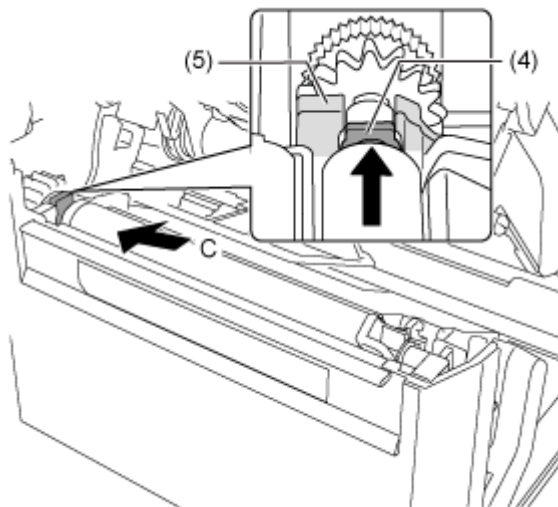

- b. Next, make sure that the tab (6) on the right driven end of the platen roller is pointing upward. Push the platen roller again in the direction C so that the tab (6) is fixed in the groove (7) at the driven side.

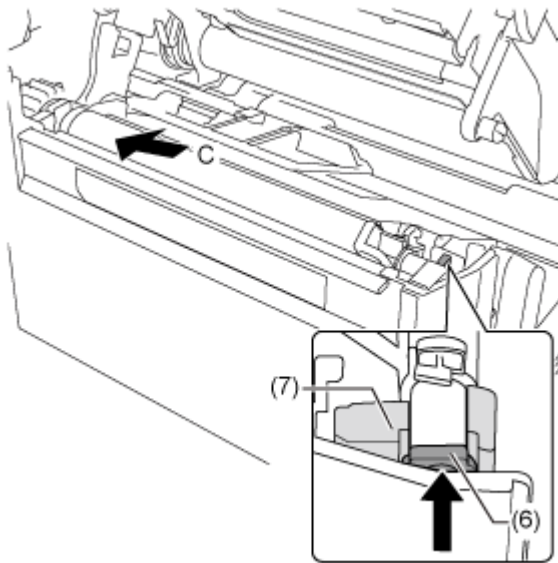

- 6. Turn the lever (2) back to lock the platen roller.



Operating the Notification Screen of SOS (SATO Online Services) (SOS users only)

Operating the Notification Screen of the SOS (SATO Online Services) On-Demand Mode (SOS users only)

In the SOS (SATO Online Services) function, the product information is sent to the SOS cloud and monitored and managed.

The status icon  and the notification screen appear at the time specified when [SOS Mode] is set to [On-Demand] in the [Interface] > [Network] > [Services] > [Online Services] menu and [Periodic Notification] is enabled on the product. A QR code with the product information is displayed on the notification screen. You can send the product information to the SOS cloud by scanning the QR code with a tablet or a smartphone.

The following shows how to operate the notification screen.

The soft key function changes according to the setting of [Update Screen].

When [Update Screen] Is Set to [Normal]

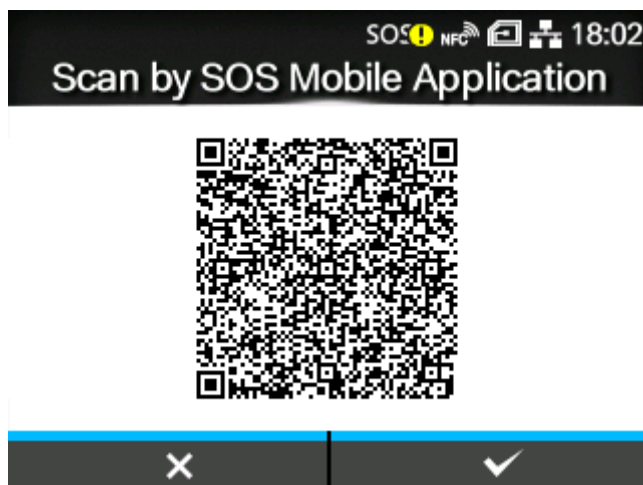

By pressing the  button, the display returns to the Offline screen without resetting the QR code for periodic notification.

The status icon remains .

By pressing the  button, the QR code for periodic notification is reset and the display returns to the Offline screen.

The status icon changes to .

When [Update Screen] Is Set to [Print]

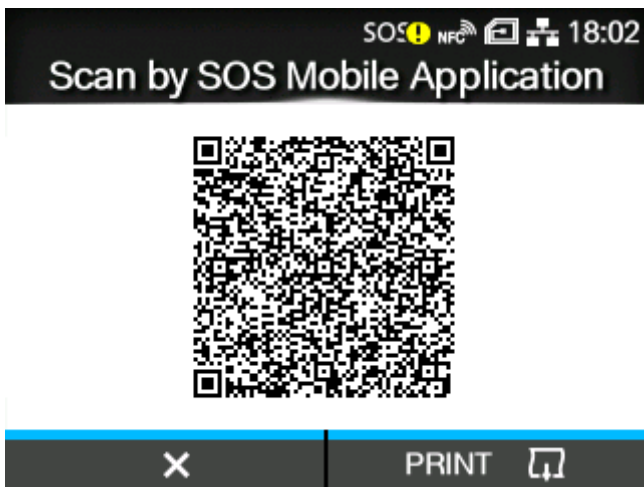

By pressing the  button, the QR code for periodic notification is reset and the display returns to the Offline screen.

The status icon changes to .

By pressing the  button, the QR code for periodic notification is printed.



- QR codes can also be displayed from [Daily Checkup].
-

Operating the Date and Time Settings Notification Screen of SOS (SATO Online Services) (SOS users only)

To use the SOS (SATO Online Services) function, date and time settings of the product and the SOS server must be matched. A notification screen appears when there is a problem with the date and time settings and the product cannot connect to SOS. Follow the steps on the screen and set the date and time correctly.



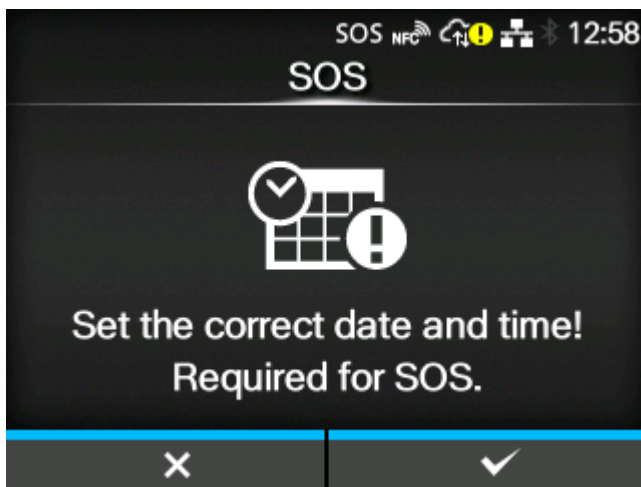

1. Press the  button on the notification screen.



Clear the NTP server connection problem when the NTP function is enabled. The notification screen appears every 15 seconds until the NTP server connection problem is cleared.



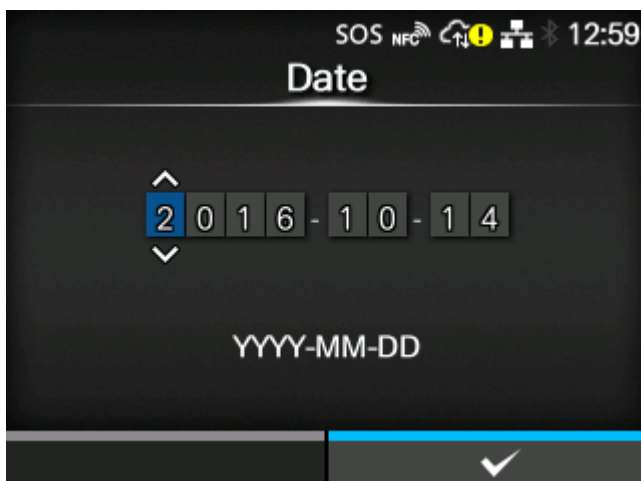

The date and time setting screen appears when the NTP function is disabled or the optional RTC kit is installed. Proceed to step 2.

2. Set the correct date and press the  button.

Select the digit for input using the  /  buttons and select the number to input using the  /  buttons.



3. Set the correct time and press the  button.

Select the digit for input using the  /  buttons and select the number to input using the  /  buttons.

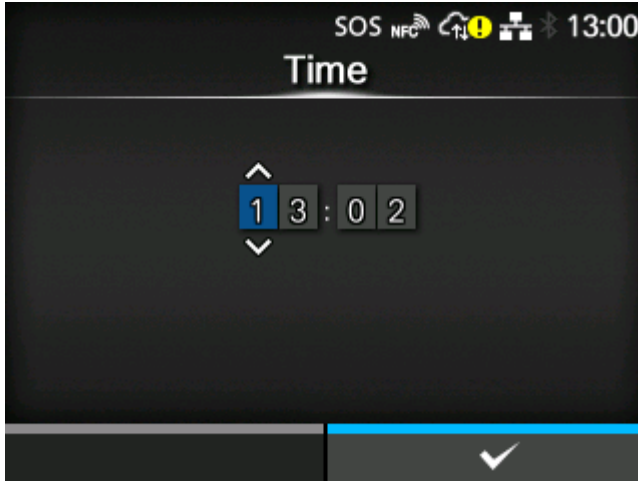

- SOS will not operate if you cancel the date and time settings by pressing the  button on the notification screen. To display the notification screen again, reboot the product or change the setting of [On-Demand]/[Real-Time] in [SOS Mode] a few times to reboot the SOS function.

SOS (SATO Online Services) Application (SOS users only)

When the SOS (SATO Online Services) mode is enabled on the product, a QR code is displayed on the screen at the time of the error outbreak or the timing that is set to perform periodic notification. By scanning the QR code with a tablet or a smartphone, you can check how to clear the error according to the current product information in the QR code. You can also contact your SATO technical support directly from this specialized application by phone or e-mail.

Also, the product information can be acquired via NFC and sent to the SOS cloud.

The SOS application allows you to check the operation information of the product, save and apply clones, and request repairs. You can also use asset management functions in the SOS cloud.

For instructions on installing and using the SOS application, refer to the SOS application user's manual.



https://www.sato-sos.com/en/support/#sos_use_manual

When You Are in Trouble

When an Error Message Appears

Error Message 1001 (Machine Error)

When there is an error with the product, the error message appears on the screen.

Check the cause and countermeasure, and then take appropriate action.

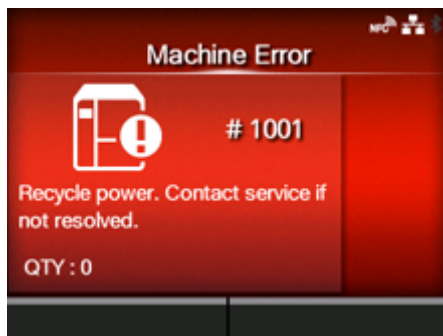

To clear the error:

Power off the product.

Cause and Countermeasure	Reference
<p>Cause</p> <p>A defect has occurred in the product.</p> <p>Countermeasure</p> <p>Power the product off and then on again.</p>	<p> Powering On/Off the Product</p>

Contact your SATO technical support if the error cannot be resolved.

 [Contact Information for When You Are in Trouble](#)



Error Message 1003 (Parity Error)

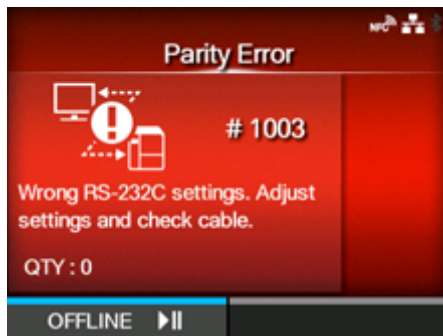

When there is an error with the product, the error message appears on the screen.

Check the cause and countermeasure, and then take appropriate action.



To clear the error:

Press the  button (OFFLINE) or  button, or adjust the settings.

Cause and Countermeasure	Reference
<p>Cause (1) RS-232C settings are incorrect.</p> <p>Countermeasure (1) Set the interface settings of the product again.</p>	<p> RS-232C</p>
<p>Cause (2) The RS-232C cable is not connected correctly.</p> <p>Countermeasure (2) Power off the product, connect the RS-232C cable correctly, and then power on the product again.</p>	<p> Powering On/Off the Product</p> <p> RS-232C Interface Connection (Standard)</p>

Contact your SATO technical support if the error cannot be resolved.

 [Contact Information for When You Are in Trouble](#)



Error Message 1004 (Overrun Error)

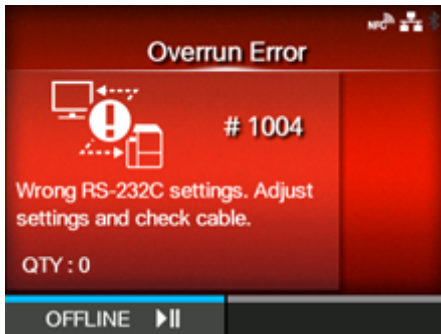

When there is an error with the product, the error message appears on the screen.

Check the cause and countermeasure, and then take appropriate action.



To clear the error:

Press the  button (OFFLINE) or  button, or adjust the settings.

Cause and Countermeasure	Reference
<p>Cause (1) RS-232C settings are incorrect.</p> <p>Countermeasure (1) Set the interface settings of the product again.</p>	<p> RS-232C</p>
<p>Cause (2) The RS-232C cable is not connected correctly.</p> <p>Countermeasure (2) Power off the product, connect the RS-232C cable correctly, and then power on the product again.</p>	<p> Powering On/Off the Product</p> <p> RS-232C Interface Connection (Standard)</p>

Contact your SATO technical support if the error cannot be resolved.

 [Contact Information for When You Are in Trouble](#)



Error Message 1005 (Framing Error)



When there is an error with the product, the error message appears on the screen.

Check the cause and countermeasure, and then take appropriate action.



To clear the error:

Press the  button (OFFLINE) or  button, or adjust the settings.

Cause and Countermeasure	Reference
<p>Cause (1) RS-232C settings are incorrect.</p> <p>Countermeasure (1) Set the interface settings of the product again.</p>	<p> RS-232C</p>
<p>Cause (2) The RS-232C cable is not connected correctly.</p> <p>Countermeasure (2) Power off the product, connect the RS-232C cable correctly, and then power on the product again.</p>	<p> Powering On/Off the Product</p> <p> RS-232C Interface Connection (Standard)</p>

Contact your SATO technical support if the error cannot be resolved.

 [Contact Information for When You Are in Trouble](#)



Error Message 1006 (Buffer Overflow)



When there is an error with the product, the error message appears on the screen.

Check the cause and countermeasure, and then take appropriate action.



To clear the error:

Press the  button (OFFLINE) or  button, or adjust the settings.

Cause and Countermeasure	Reference
<p>Cause (1)</p> <p>The size of the received data from the host exceeds the size of the receive buffer.</p> <p>Countermeasure (1)</p> <p>Change the settings on the host so that data that exceeds the size of the receive buffer cannot be sent.</p>	<p>-</p>
<p>Cause (2)</p> <p>The interface settings between the product and the host are incorrect.</p> <p>Countermeasure (2)</p> <p>Set the interface settings of the product and host again.</p>	<p> Interface Menu</p> <p> Go to your local SATO website</p>

Contact your SATO technical support if the error cannot be resolved.

 [Contact Information for When You Are in Trouble](#)

Error Message 1007 (Head Open)

When there is an error with the product, the error message appears on the screen.
Check the cause and countermeasure, and then take appropriate action.

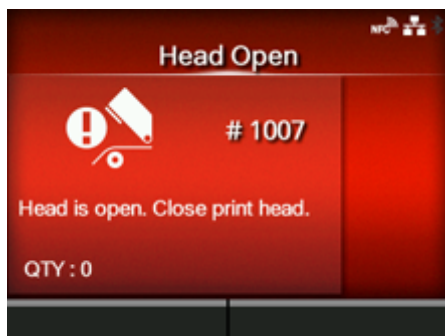

To clear the error:
Lock the print head.

Cause and Countermeasure

Cause

- The print head is unlocked.
- The sensor for detecting the open/close status of the print head is defective.

Countermeasure

Unlock the print head once, and then lock it again.

1. Push the head lock lever (1) towards the rear.

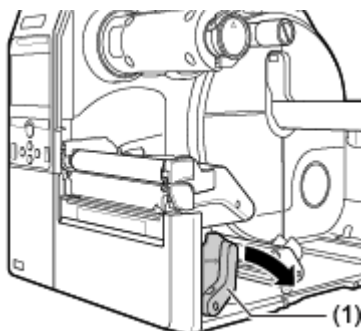

2. Press the print head down until the head lock lever is locked.

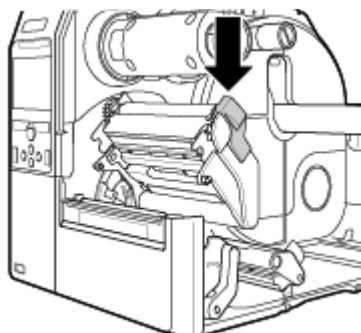

Cause and Countermeasure

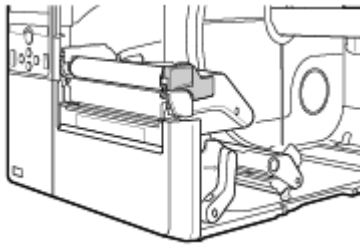

Contact your SATO technical support if the error cannot be resolved.

 [Contact Information for When You Are in Trouble](#)



Error Message 1008 (Out of Paper)





When there is an error with the product, the error message appears on the screen.

Check the cause and countermeasure, and then take appropriate action.



To clear the error:

Load the media and open/close the print head, or press the  button (OFFLINE) or the  button.

Cause and Countermeasure	Reference
<p>Cause (1) The media is not loaded.</p> <p>Countermeasure (1) Load the media.</p>	<p> Loading the Media</p>
<p>Cause (2) The media is not loaded correctly.</p> <p>Countermeasure (2) Load the media correctly.</p>	<p> Loading the Media</p>
<p>Cause (3) The media sensor level is not set correctly.</p> <p>Countermeasure (3) Adjust the media sensor level.</p>	<p> Calibrate</p>
<p>Cause (4) The media has jammed.</p> <p>Countermeasure (4) Remove the jammed media. Refer to the video for loading the media, for the media path, and for the operation of each part inside the product.</p>	<p> Loading the Media</p>

Cause and Countermeasure	Reference
<p>Cause (5)</p> <p>The media sensor is not operating correctly.</p> <ul style="list-style-type: none"> ◦ The media sensor is dirty, or there is a label attached to it. ◦ The media sensor has poor sensitivity. <p>Countermeasure (5)</p> <p>Clean the media sensor.</p>	<p> Cleaning Using the Cleaning Kit</p>

Contact your SATO technical support if the error cannot be resolved.

 [Contact Information for When You Are in Trouble](#)



Error Message 1009 (Ribbon End)



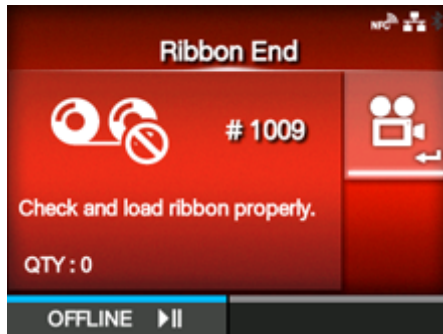

When there is an error with the product, the error message appears on the screen.

Check the cause and countermeasure, and then take appropriate action.



To clear the error:

Load the ribbon correctly and close the print head, or press the  button (OFFLINE) or  button.

Cause and Countermeasure	Reference
<p>Cause (1) The ribbon is not loaded.</p> <p>Countermeasure (1) Load the ribbon.</p>	<p> Loading Ribbon (Thermal Transfer Only)</p>
<p>Cause (2) The ribbon is not loaded correctly.</p> <p>Countermeasure (2) Load the ribbon and the media correctly.</p>	<p> Loading Ribbon (Thermal Transfer Only)</p> <p> Loading the Media</p>
<p>Cause (3) There is no ribbon.</p> <p>Countermeasure (3) Load a new ribbon.</p>	<p> Loading Ribbon (Thermal Transfer Only)</p>
<p>Cause (4) The ribbon sensor is not operating correctly.</p> <ul style="list-style-type: none"> ◦ The ribbon sensor is dirty. ◦ The ribbon sensor has poor sensitivity. 	<p> Powering On/Off the Product</p>

Cause and Countermeasure	Reference
Countermeasure (4) Power on the product again.	

Contact your SATO technical support if the error cannot be resolved.



[Contact Information for When You Are in Trouble](#)

Error Message 1010 (Media Error)

When there is an error with the product, the error message appears on the screen.

Check the cause and countermeasure, and then take appropriate action.

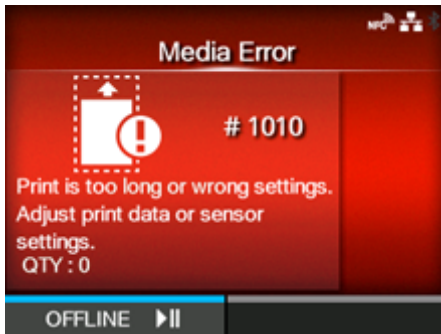

To clear the error:

Open/close the print head, or press the  button (OFFLINE) or the  button.

Cause and Countermeasure	Reference
<p>Cause (1)</p> <p>The media size of the print data and the actual media size are different.</p> <p>Countermeasure (1)</p> <p>Check the media size of the print data and the actual media size again.</p> <p>If the error is not solved, power on the product again.</p>	-
<p>Cause (2)</p> <p>The media size of the print data is longer than the actual media size.</p> <p>Countermeasure (2)</p> <p>Check the print data.</p> <p>If the error is not solved, power on the product again.</p>	-
<p>Cause (3)</p> <p>The media is fed a longer distance due to the incorrect sensor level.</p> <p>Countermeasure (3)</p> <p>Adjust the media sensor level.</p> <p>If the error is not solved, power on the product again.</p>	 Calibrate



- The media error appears when [Check Media Size] in [Advanced] under the [Printing] menu is set to [Enabled].



[Check Media Size](#)

Contact your SATO technical support if the error cannot be resolved.



[Contact Information for When You Are in Trouble](#)

Error Message 1012 (Head Error)

When there is an error with the product, the error message appears on the screen.

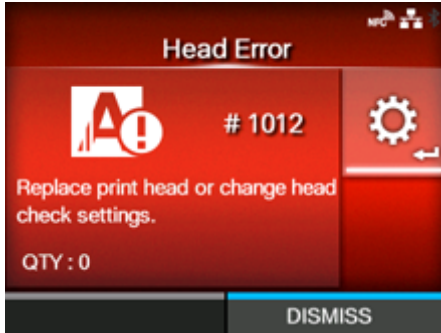

Check the cause and countermeasure, and then take appropriate action.



To clear the error:

Power off the product, or change print head check conditions.

To forcibly clear the head error and resume printing, press and hold the  button (DISMISS) until the progress bar on the blue line of the button reaches to the right end.

Cause and Countermeasure	Reference
<p>Cause (1) The print elements are worn out.</p> <p>Countermeasure (1) Power off the product, or change the print head check conditions to only check for missing elements in barcodes and try to adjust missing elements to white bars.</p>	<p> Powering On/Off the Product</p> <p> Head Check</p>
<p>Cause (2) The print head is worn or damaged.</p> <p>Countermeasure (2) Replace the print head.</p>	<p> Replacing the Print Head</p>

Contact your SATO technical support if the error cannot be resolved.

 [Contact Information for When You Are in Trouble](#)



- Regarding labels output after a head error, use your own barcode scanner to read and check the printed barcodes.



Error Message 1013 (USB R/W Error)

When there is an error with the product, the error message appears on the screen.

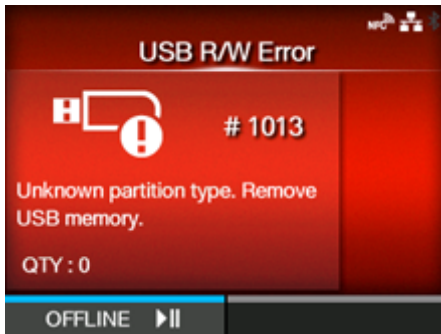
Check the cause and countermeasure, and then take appropriate action.



To clear the error:

Connect the USB memory and then disconnect it, or press the  button (OFFLINE) or the  button.

Cause and Countermeasure

Cause (1)

The USB memory is disconnected while writing.

Countermeasure (1)

Connect the USB memory.

Cause (2)

The copy area in the USB memory is not sufficient.

Countermeasure (2)

Make sure that the USB memory has sufficient copy area.

Cause (3)

Writing to the USB memory fails.

Countermeasure (3)

Replace the USB memory.

Cause (4)

The USB memory is not formatted.

Countermeasure (4)

Format the USB memory to FAT32 format.

Contact your SATO technical support if the error cannot be resolved.



[Contact Information for When You Are in Trouble](#)



Error Message 1014 (USB Memory Full)

When there is an error with the product, the error message appears on the screen.

Check the cause and countermeasure, and then take appropriate action.



To clear the error:

Connect the USB memory with sufficient space, or press the  button (OFFLINE) or  button.

Cause and Countermeasure

Cause

The space in the USB memory is not sufficient.

Countermeasure

Delete unwanted data from the USB memory or insert a USB memory with sufficient space.

Contact your SATO technical support if the error cannot be resolved.

 [Contact Information for When You Are in Trouble](#)

Error Message 1015 (Cutter Error)



When there is an error with the product, the error message appears on the screen.

Check the cause and countermeasure, and then take appropriate action.



To clear the error:

Press the  button (FEED).

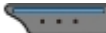
Cause and Countermeasure	Reference
<p>Cause (1)</p> <p>A media jam has occurred in the cutter.</p> <p>Countermeasure (1)</p> <p>Remove the jammed media from the cutter.</p> <p>Refer to the video for loading the media, for the media path, and for the operation of each part inside the product.</p> <hr/> <p> • Be careful not to cause injury with the cutter blade when removing the media.</p> <hr/> <p>If the error is not solved, power on the product again.</p>	<p> Loading the Media with the Optional Cutter Unit</p> <p> Loading the Media with the Optional Rotary Cutter Unit (CL4NX Plus Only)</p>
<p>Cause (2)</p> <p>The cutter blade does not return to the specified position.</p> <p>Countermeasure (2)</p> <p>Press the  button (FEED) to move the cutter blade back to the specified position.</p> <p>If the error is not solved, power on the product again.</p>	<p>-</p>

Contact your SATO technical support if the error cannot be resolved.

 [Contact Information for When You Are in Trouble](#)

Error Message 1016 (Cutter Cover Open)



When there is an error with the product, the error message appears on the screen.

Check the cause and countermeasure, and then take appropriate action.



To clear the error:

Close the cutter.

Cause and Countermeasure	Reference
<p>Cause (1) The cutter-open lever is open.</p> <p>Countermeasure (1) Close and lock the cutter-open lever.</p>	<p> Loading the Media with the Optional Cutter Unit</p>
<p>Cause (2) The cutter unit is defective.</p> <p>Countermeasure (2) Power the product off and then on again.</p>	<p> Powering On/Off the Product</p>

Contact your SATO technical support if the error cannot be resolved.

 [Contact Information for When You Are in Trouble](#)



Error Message 1017 (SBPL Command Error)

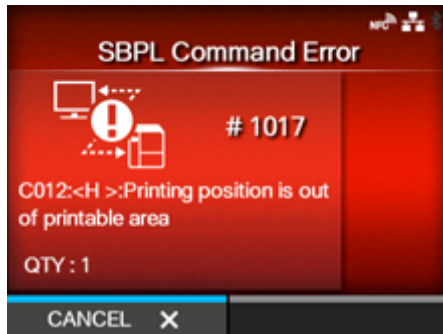

When there is an error with the product, the error message appears on the screen.

Check the cause and countermeasure, and then take appropriate action.



To clear the error:

Press the  button (CANCEL) or  button.

Cause and Countermeasure	Reference
<p>Cause</p> <p>Incorrect command or parameter in the print data.</p> <p>For details about the error, check the "Caaa: <bb>: cc" part below the error number.</p> <ul style="list-style-type: none"> ◦ Caaa: position of error occurrence ◦ <bb>: error command name ◦ cc: error content <p>Countermeasure</p> <p>Check the print data.</p> <p>If the error is not solved, power on the product again.</p> <hr/> <p> • The command error appears when [Show Error] in [SBPL] under the [Applications] menu is set to [Enabled].</p>	<p> How to See the Command Error Information</p> <p> Show Error</p>

Contact your SATO technical support if the error cannot be resolved.

 [Contact Information for When You Are in Trouble](#)

How to See the Command Error Information

- **Location of error occurrence**

"Caaa" in the command error message shows the location of command error.
 The number of ESC commands from start code <A> command is shown in "aaa".
 Note that the start code <A> command is not included in the number of ESC commands, which can be shown up to 999.
 When a command error is detected by the Horizontal Print Position <H> command.

```
-----: [ESC]A
C001: [ESC]V100
C002: [ESC]H99999
C003: [ESC]L0202
C004: [ESC]M,ABCDEF
C005: [ESC]Q1
C006: [ESC]Z
```

In this case, C002 is the location of the error.

- **Error command name**

The command name is shown in "<bb>". Error is detected in the command name.

- A one-byte command name is left aligned

- **Error description**

The cause of command error appears in "cc" in the error message ("Caaa:<bb>:cc").

Description ("cc")	Cause
Invalid command	Analyzed improper command.
Invalid parameter	Received improper parameter.
Command table read error	Failed to read the command table.
Invalid graphic data/ custom designed data	Analyzed improper graphic and custom designed data.
Invalid registration area	<ul style="list-style-type: none"> • Specified memory area (card slot) is inappropriate. • Tried to write to a write-protected media.
This number is already registered.	Number specified by registration command has already been taken.
Over registration area limit	Exceeded the registration area. (Memory full)
Data is not registered	Data, such as form overlay, is not registered.

Description ("cc")	Cause
Printing position is out of printable area	The specified print start position is outside the printable area.
Barcode image is out of printable area	The printing image is outside the printable area. (Barcode only)

Error Message 1019 (RFID System Error)

When there is an error with the product, the error message appears on the screen.

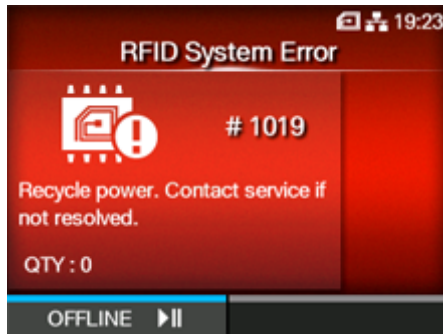

Check the cause and countermeasure, and then take appropriate action.



To clear the error:

Press the  button (OFFLINE).

Because the RFID module is not operating correctly, writing information to inlays or reading information from inlays cannot be executed, but printing on the surface of tags can be done.

Cause and Countermeasure	Reference
<p>Cause (1) RFID module is not operating correctly.</p> <p>Countermeasure (1) Repair or replacement of the RFID module is required. Contact your SATO technical support.</p>	<p> Contact Information for When You Are in Trouble</p>
<p>Cause (2) The setting of the SATO RF Analyze (SRA) board is incorrect.</p> <p>Countermeasure (2) The setting of the SRA board needs to be changed. Contact your SATO technical support.</p>	<p> Contact Information for When You Are in Trouble</p>
<p>Cause (3) The SATO RF Analyze (SRA) board is not connected.</p> <p>Countermeasure (3) The SRA board needs to be connected. Contact your SATO technical support.</p>	<p> Contact Information for When You Are in Trouble</p>

Error Message 1020 (Calendar Error)

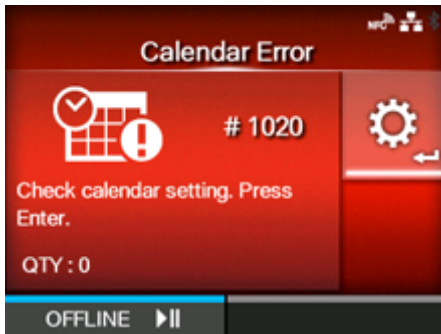

When there is an error with the product, the error message appears on the screen.

Check the cause and countermeasure, and then take appropriate action.



To clear the error:

Change the calendar (option) settings, press the  button (OFFLINE) or  button, or power off the product.

Cause and Countermeasure	Reference
<p>Cause (1)</p> <p>The date and time of the calendar are incorrect.</p> <p>Countermeasure (1)</p> <p>Set the calendar again.</p>	<p> Regional</p>
<p>Cause (2)</p> <p>The battery for the calendar is running low.</p> <p>Countermeasure (2)</p> <p>The battery for the calendar needs to be changed. Contact your SATO technical support.</p>	<p> Contact Information for When You Are in Trouble</p>



Error Message 1021 (BCC Check Error)

When there is an error with the product, the error message appears on the screen.

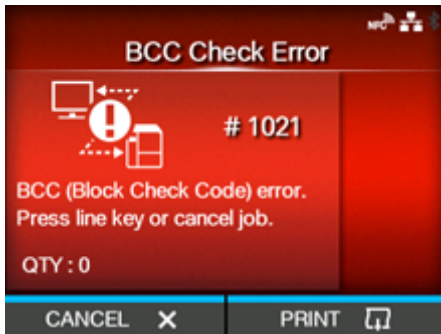
Check the cause and countermeasure, and then take appropriate action.



To clear the error:

Press the  button (CANCEL) or  button.

Cause and Countermeasure

Cause

The BCC code of the transmitted data (one item) is incorrect.

Countermeasure

Check the transmitted data and interface settings.

- [PRINT]: Continue printing from the print data where the BCC error occurred.
- [CANCEL]: Cancel the print data where the BCC error occurred and continue printing from the next item.
- Send the SUB command: Clear the BCC error and continue printing from where it stopped.
- Send the CAN command: Cancel the print data where the BCC error occurred and continue printing from the next item.

Contact your SATO technical support if the error cannot be resolved.

 [Contact Information for When You Are in Trouble](#)

Error Message 1022 (Print Head Overheated)

When there is an error with the product, the error message appears on the screen.

Check the cause and countermeasure, and then take appropriate action.



To clear the error:

Stop the operation of the product to let the temperature decrease.

Cause and Countermeasure

Cause

The temperature of the product has exceeded its tolerance value.

Countermeasure

Stop the operation of the product to let the temperature decrease.

Contact your SATO technical support if the error cannot be resolved.

 [Contact Information for When You Are in Trouble](#)

Error Message 1023 (NTP Error)

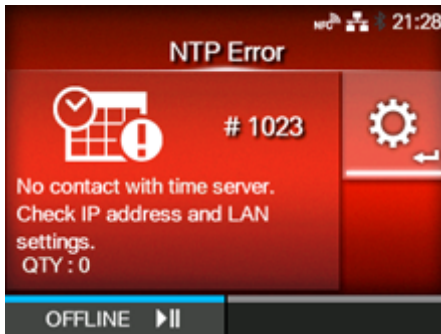

When there is an error with the product, the error message appears on the screen.

Check the cause and countermeasure, and then take appropriate action.



To clear the error:

Press the  button (OFFLINE) or change the calendar setting.

Cause and Countermeasure	Reference
<p>Cause</p> <p>Could not connect to the time server and set the date and time.</p> <p>Countermeasure</p> <ul style="list-style-type: none">◦ Confirm that the address of the time server is correct.◦ Confirm that there is a connection to the time server.◦ If RTC kit is attached, the date and time can be set manually and operation resumed without NTP functionality.	<p> Time Server IP</p> <p> Regional</p>

Contact your SATO technical support if the error cannot be resolved.

 [Contact Information for When You Are in Trouble](#)

Error Message 1024 (Head Density Changed)



When there is an error with the product, the error message appears on the screen.

Check the cause and countermeasure, and then take appropriate action.



To clear the error:

Check the message that appeared on the screen.

Cause and Countermeasure	Reference
<p>Cause (1) The print head is not installed.</p> <p>Countermeasure (1) Install the print head.</p>	 Replacing the Print Head
<p>Cause (2) A new print head with a different resolution has been installed.</p> <p>Countermeasure (2) Install a print head with the same resolution as the old print head.</p>	 Replacing the Print Head

Contact your SATO technical support if the error cannot be resolved.

 [Contact Information for When You Are in Trouble](#)

Error Message 1028 (Gap Not Found)



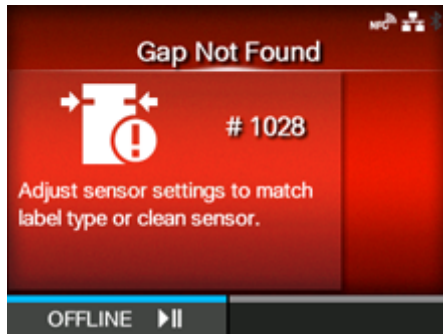

When there is an error with the product, the error message appears on the screen.

Check the cause and countermeasure, and then take appropriate action.



To clear the error:

Press the  button (OFFLINE) or open/close the print head.

Cause and Countermeasure	Reference
<p>Cause (1) Meandering media.</p> <p>Countermeasure (1) Load the media correctly.</p>	<p> Loading the Media</p>
<p>Cause (2) A label is attached to the media sensor.</p> <p>Countermeasure (2) Clean the media sensor.</p>	<p> Cleaning Using the Cleaning Kit</p>
<p>Cause (3) The media sensor type is incorrect.</p> <p>Countermeasure (3) Set the media sensor type which is compatible with the media you use.</p>	<p> Media Sensor Type</p>
<p>Cause (4) The media sensor level is incorrect.</p> <p>Countermeasure (4) Adjust the media sensor level.</p>	<p> Calibrate</p>

Contact your SATO technical support if the error cannot be resolved.

 [Contact Information for When You Are in Trouble](#)

Error Message 1035 (I-mark Not Found)



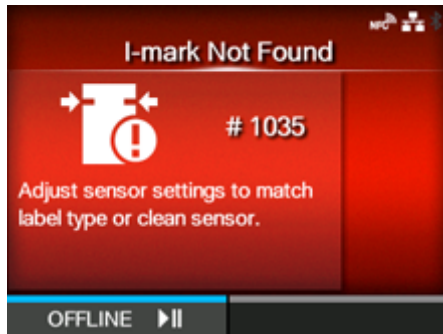

When there is an error with the product, the error message appears on the screen.

Check the cause and countermeasure, and then take appropriate action.



To clear the error:

Press the  button (OFFLINE) or open/close the print head.

Cause and Countermeasure	Reference
<p>Cause (1) Meandering media.</p> <p>Countermeasure (1) Load the media correctly.</p>	<p> Loading the Media</p>
<p>Cause (2) A label is attached to the media sensor.</p> <p>Countermeasure (2) Clean the media sensor.</p>	<p> Cleaning Using the Cleaning Kit</p>
<p>Cause (3) The media sensor type is incorrect.</p> <p>Countermeasure (3) Set the media sensor type which is compatible with the media you use.</p>	<p> Media Sensor Type</p>
<p>Cause (4) The media sensor level is incorrect.</p> <p>Countermeasure (4) Adjust the media sensor level.</p>	<p> Calibrate</p>

Contact your SATO technical support if the error cannot be resolved.



[Contact Information for When You Are in Trouble](#)

Error Message 1046 (EAP Authentication Error (EAP Failure))

When there is an error with the product, the error message appears on the screen.

Check the cause and countermeasure, and then take appropriate action.

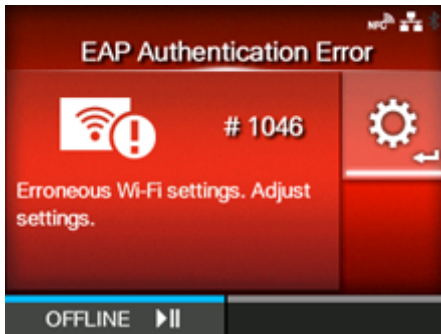

To clear the error:

Change the Wi-Fi settings or press the  button (OFFLINE).

Cause and Countermeasure	Reference
<p>Cause</p> <p>EAP Authentication failure.</p> <p>Countermeasure</p> <p>Use the correct Wi-Fi settings.</p>	<p> EAP Conf.</p>

Contact your SATO technical support if the error cannot be resolved.

 [Contact Information for When You Are in Trouble](#)

Error Message 1047 (EAP Authentication Error (EAP Timeout))

When there is an error with the product, the error message appears on the screen.

Check the cause and countermeasure, and then take appropriate action.

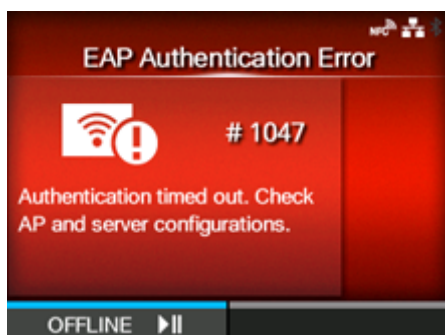

To clear the error:

Press the  button (OFFLINE).

Cause and Countermeasure	Reference
<p>Cause</p> <p>EAP Authentication failure.</p> <p>Countermeasure</p> <p>Use the correct Access Point (AP) and authentication server settings.</p>	<p> EAP Conf.</p>

Contact your SATO technical support if the error cannot be resolved.

 [Contact Information for When You Are in Trouble](#)

Error Message 1050 (Bluetooth Error)

When there is an error with the product, the error message appears on the screen.

Check the cause and countermeasure, and then take appropriate action.

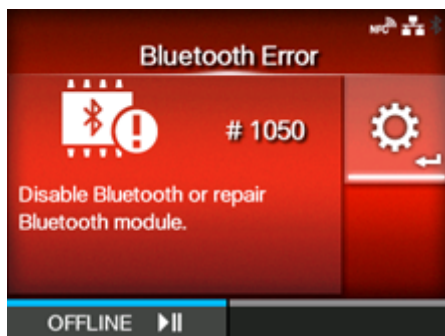

To clear the error:

Check the message that appeared on the screen.

Cause and Countermeasure	Reference
<p>Cause</p> <p>Bluetooth module is defective.</p> <p>Countermeasure</p> <p>Repair of the Bluetooth module is required. Contact your SATO technical support.</p>	<p> Contact Information for When You Are in Trouble</p>

Error Message 1058 (CRC Check Error)

When there is an error with the product, the error message appears on the screen.

Check the cause and countermeasure, and then take appropriate action.

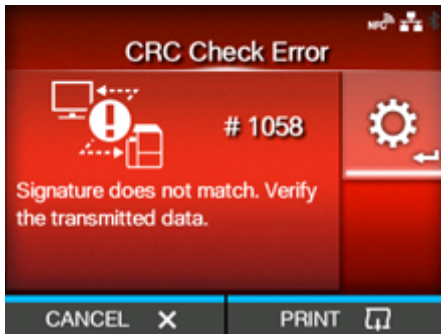

To clear the error:

Press the  button (CANCEL) or  button (PRINT).

Cause and Countermeasure

Cause

- CRC has not been added to the data.
- CRC does not match.

Countermeasure

Check transmitted data and interface settings.

- [PRINT]: Continue printing from the print data where the CRC error occurred.
- [CANCEL]: Cancel the print data where the CRC error occurred and continue printing from the next item.

Contact your SATO technical support if the error cannot be resolved.

 [Contact Information for When You Are in Trouble](#)

Error Message 1066 (Paper Jam) (CL4NX Plus Only)



When there is an error with the product, the error message appears on the screen.

Check the cause and countermeasure, and then take appropriate action.



To clear the error:

Unlock the print head and load the media again.

Cause and Countermeasure	Reference
<p>Cause (1)</p> <p>The media has jammed.</p> <p>Countermeasure (1)</p> <p>Remove the jammed media.</p> <p>Refer to the video for loading the media, for the media path, and for the operation of each part inside the product.</p>	<p> Loading the Media</p>
<p>Cause (2)</p> <p>The media is not loaded correctly.</p> <p>Countermeasure (2)</p> <p>Load the media correctly. Load the media so its leading edge is further forward than the cutter blade.</p>	<p> Loading the Media</p>

Contact your SATO technical support if the error cannot be resolved.

 [Contact Information for When You Are in Trouble](#)

Error Message 1068 (WLAN Error)

When there is an error with the product, the error message appears on the screen.

Check the cause and countermeasure, and then take appropriate action.

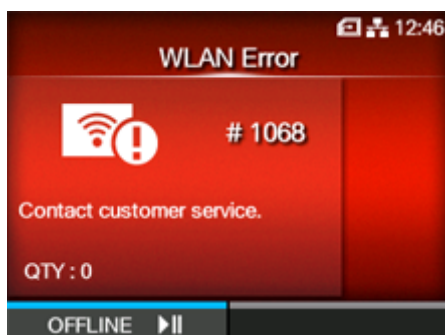

To clear the error:

Press the  button (OFFLINE).

Cause and Countermeasure	Reference
<p>Cause</p> <p>The wireless LAN module is damaged.</p> <p>Countermeasure</p> <p>The wireless LAN module needs to be replaced. Contact your SATO technical support.</p>	<p> Contact Information for When You Are in Trouble</p>

Error Message 1073 (RFID Undetected)

When there is an error with the product, the error message appears on the screen.

Check the cause and countermeasure, and then take appropriate action.

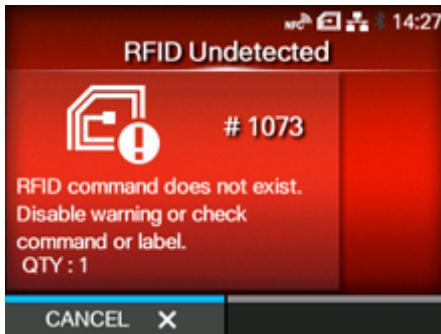

To clear the error:

Press the  button (CANCEL) or open/close the print head.

Cause and Countermeasure	Reference
<p>Cause</p> <p>With [RFID Undetected Warning] enabled and RFID tag loaded, the items received do not contain an RFID issue command.</p> <p>Countermeasure</p> <ul style="list-style-type: none">◦ Add an RFID issue command to the print job.◦ Set [RFID Undetected Warning] to [Disable].◦ Replace with normal media.	<p> RFID Undetected Warning</p>

Contact your SATO technical support if the error cannot be resolved.

 [Contact Information for When You Are in Trouble](#)

Error Message 1075 (NFC Error)

When there is an error with the product, the error message appears on the screen.
Check the cause and countermeasure, and then take appropriate action.

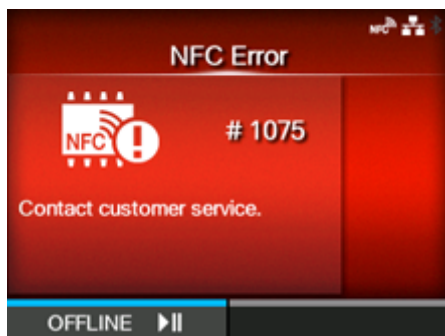

To clear the error:

Press the  button (OFFLINE).

Cause and Countermeasure	Reference
<p>Cause</p> <p>The NFC module is not operating correctly.</p> <p>Countermeasure</p> <p>A replacement of the NFC module is required. Contact your SATO technical support.</p>	<p> Contact Information for When You Are in Trouble</p>

Error Message 1076 (Invalid command in NFC)

When there is an error with the product, the error message appears on the screen.
Check the cause and countermeasure, and then take appropriate action.

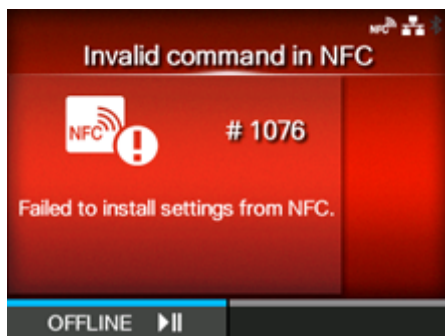

To clear the error:

Press the  button (OFFLINE).

Cause and Countermeasure

Cause

A command error occurs and the settings are not saved correctly.

Countermeasure

Check the command.

Contact your SATO technical support if the error cannot be resolved.

 [Contact Information for When You Are in Trouble](#)

Error Message 1077 (Barcode Reader Connection Error)

When there is an error with the product, the error message appears on the screen.

Check the cause and countermeasure, and then take appropriate action.

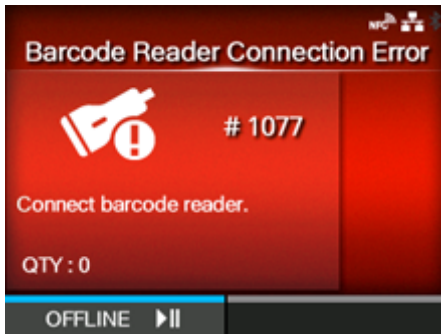

To clear the error:

Connect the barcode checker, or press the  button (OFFLINE).

Cause and Countermeasure	Reference
<p>Cause</p> <ul style="list-style-type: none">◦ Could not check the connection of the barcode checker.◦ Communication between the barcode checker and the product fails. <p>Countermeasure</p> <p>Check the barcode checker, and connect it correctly.</p> <p>If you do not use the barcode check function, disable the barcode check mode.</p>	<p> Mode</p>

Contact your SATO technical support if the error cannot be resolved.

 [Contact Information for When You Are in Trouble](#)

Error Message 1078 (Barcode Reading Error)

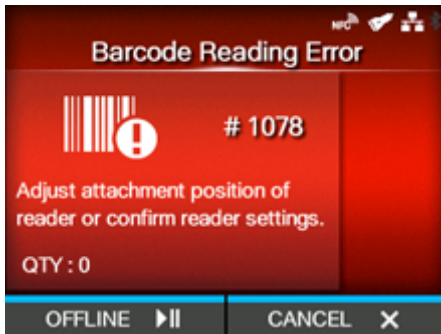

When there is an error with the product, the error message appears on the screen.

Check the cause and countermeasure, and then take appropriate action.

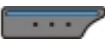

To clear the error:

Press the  button (OFFLINE) or  button (CANCEL).

- Press the  button (OFFLINE) to change to Offline mode while keeping the print job.
- Press the  button (CANCEL) to cancel the print job and change to Offline mode.

Cause and Countermeasure	Reference
<p>Cause</p> <p>Could not read the barcode correctly.</p> <p>Countermeasure</p> <ul style="list-style-type: none">◦ Check the layout for printing.◦ Check the barcode checker position and its settings.	<p> Configuring Optional Barcode Check Function</p>

Contact your SATO technical support if the error cannot be resolved.

 [Contact Information for When You Are in Trouble](#)

Error Message 1079 (Barcode Reading Error (Checking Start Position Abnormality))

When there is an error with the product, the error message appears on the screen.

Check the cause and countermeasure, and then take appropriate action.

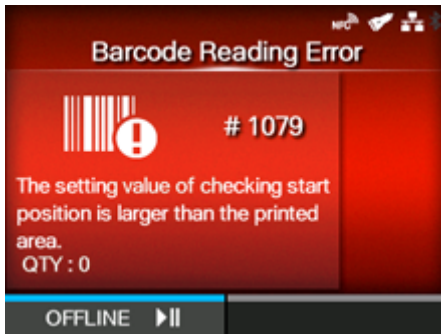

To clear the error:

Press the  button (OFFLINE). The product changes to Offline mode while keeping the print job.

Cause and Countermeasure	Reference
<p>Cause</p> <p>A value larger than the loaded media length is specified for checking start position.</p> <p>Countermeasure</p> <ul style="list-style-type: none">◦ Check the layout for printing.◦ Set a value smaller than the loaded media length for checking start position.	<p> Start Position</p>

Contact your SATO technical support if the error cannot be resolved.

 [Contact Information for When You Are in Trouble](#)

Error Message 1080 (Barcode Comparison Error)

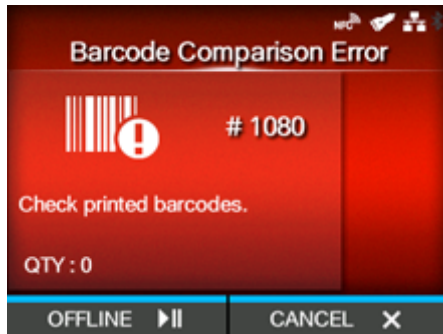

When there is an error with the product, the error message appears on the screen.

Check the cause and countermeasure, and then take appropriate action.



To clear the error:

Press the  button (OFFLINE) or  button (CANCEL).

- Press the  button (OFFLINE) to change to Offline mode while keeping the print job.
- Press the  button (CANCEL) to cancel the print job and change to Offline mode.

Cause and Countermeasure	Reference
<p>Cause</p> <p>The read result of the barcode does not match the print data.</p> <p>Countermeasure</p> <ul style="list-style-type: none">◦ Check the layout for printing.◦ Check the barcode checker position and its settings.	<p> Configuring Optional Barcode Check Function</p>

Contact your SATO technical support if the error cannot be resolved.

 [Contact Information for When You Are in Trouble](#)

Error Message 1099 (Config Warning)

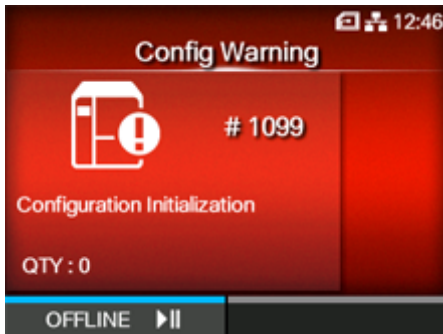

When there is an error with the product, the error message appears on the screen.

Check the cause and countermeasure, and then take appropriate action.



To clear the error:

Press the  button (OFFLINE).

Cause and Countermeasure	Reference
<p>Cause</p> <p>The power was cut off in an inappropriate way, such as the power cord was pulled out while the power was on.</p> <p>Countermeasure</p> <ul style="list-style-type: none">◦ Power off the product correctly.◦ Reset the product in the Settings menu.	<p> Powering Off the Product</p> <p> The Product's Settings Menu</p>

Contact your SATO technical support if the error cannot be resolved.

 [Contact Information for When You Are in Trouble](#)



Error Message 1114 (Tag not Found)

When there is an error with the product, the error message appears on the screen.

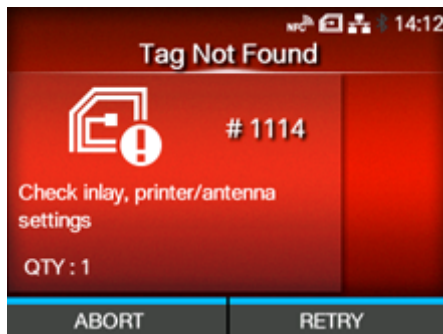
Check the cause and countermeasure, and then take appropriate action.





To clear the error:

Press the  button (RETRY), and then execute the retry/release operation set in [Retry Mode], or press the  button (ABORT).

 [Retry Mode](#)

To cancel an entire print job, open and close the top cover to switch the product to Offline mode, and then press the  button (CANCEL).

Cause and Countermeasure	Reference
<p>Cause</p> <p>Did not find the tag, or failed to read the tag.</p> <p>Countermeasure</p> <p>Confirm the inlay and check the product and antenna settings.</p>	<p> RFID Settings (RFID Models Only)</p> <p> RFID (RFID Models Only)</p>

Contact your SATO technical support if the error cannot be resolved.

 [Contact Information for When You Are in Trouble](#)



- You cannot use an RFID tag that has caused an RFID tag error. An error message is printed on the RFID tag that caused the error.



Error Message 1115 (Write Tag Error)

When there is an error with the product, the error message appears on the screen.

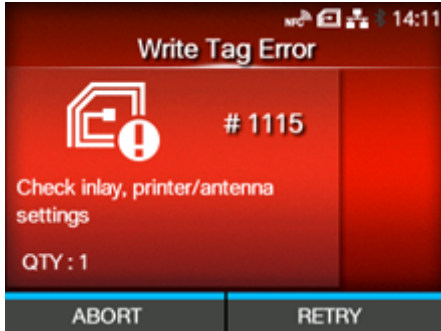
Check the cause and countermeasure, and then take appropriate action.



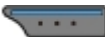

To clear the error:

Press the  button (RETRY), and then execute the retry/release operation set in [Retry Mode], or press the  button (ABORT).

 [Retry Mode](#)

To cancel an entire print job, open and close the top cover to switch the product to Offline mode, and then press the  button (CANCEL).

Cause and Countermeasure	Reference
<p>Cause</p> <p>Failed to write the inlay.</p> <p>Countermeasure</p> <p>Confirm the inlay and check the product and antenna settings.</p>	<p> RFID Settings (RFID Models Only)</p> <p> RFID (RFID Models Only)</p>

Contact your SATO technical support if the error cannot be resolved.

 [Contact Information for When You Are in Trouble](#)



- You cannot use an RFID tag that has caused an RFID tag error. An error message is printed on the RFID tag that caused the error.



Error Message 1116 (Failed to Read the Tag Data)

When there is an error with the product, the error message appears on the screen.

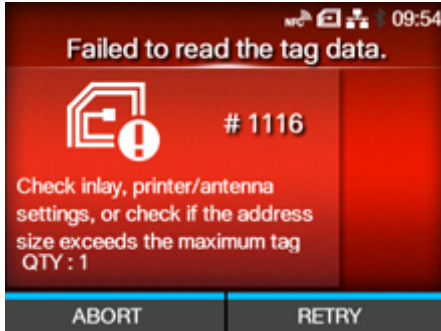
Check the cause and countermeasure, and then take appropriate action.



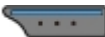



To clear the error:

Press the  button (RETRY), and then execute the retry/release operation set in [Retry Mode], or press the  button (ABORT).

 [Retry Mode](#)

To cancel an entire print job, open and close the top cover to switch the product to Offline mode, and then press the  button (CANCEL).

Cause and Countermeasure	Reference
<p>Cause (1)</p> <p>Failed to read the tag by using the tag data print <TU> command.</p> <p>Countermeasure (1)</p> <ul style="list-style-type: none"> ◦ Confirm the inlay and check the product and antenna settings. ◦ Confirm that an address that exceeds the inlay volume has not been specified. 	<p> RFID Settings (RFID Models Only)</p> <p> RFID (RFID Models Only)</p>
<p>Cause (2)</p> <p>Failed to replace the loaded tag.</p> <p>Countermeasure (2)</p> <p>Confirm the inlay and check the product and antenna settings.</p>	<p> RFID Settings (RFID Models Only)</p> <p> RFID (RFID Models Only)</p>

Contact your SATO technical support if the error cannot be resolved.

 [Contact Information for When You Are in Trouble](#)



- You cannot use an RFID tag that has caused an RFID tag error. An error message is printed on the RFID tag that caused the error.
-



Error Message 1117 (Write Tag Error) (CL4NX Plus Only)

When there is an error with the product, the error message appears on the screen.

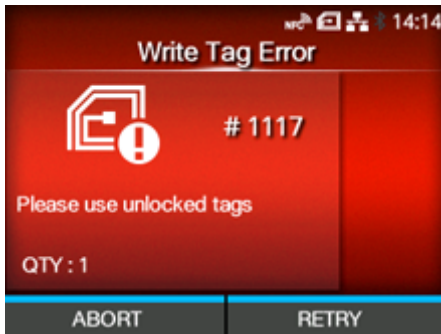
Check the cause and countermeasure, and then take appropriate action.

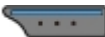

To clear the error:

Press the  button (RETRY), and then execute the retry/release operation set in [Retry Mode], or press the  button (ABORT).

 [Retry Mode](#)

To cancel an entire print job, open and close the top cover to switch the product to Offline mode, and then press the  button (CANCEL).

Cause and Countermeasure

ISO/IEC 15693, FeliCa only

Cause (1)

Tried to write to a write-locked inlay.

Countermeasure (1)

Use tags that are not locked.

ISO/IEC 15693, FeliCa only

Cause (2)

Tried to write to an address to which writing is impossible.

Countermeasure (2)

Use tags that are not locked.

Contact your SATO technical support if the error cannot be resolved.

 [Contact Information for When You Are in Trouble](#)



- You cannot use an RFID tag that has caused an RFID tag error. An error message is printed on the RFID tag that caused the error.



Error Message 1118 (Write/Read Values Are not Consistent)

When there is an error with the product, the error message appears on the screen.

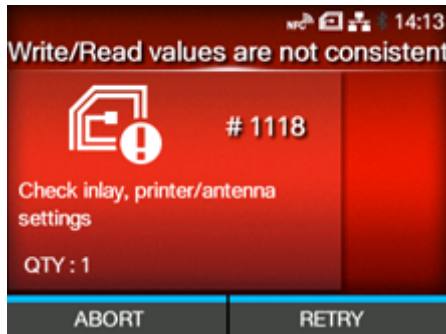
Check the cause and countermeasure, and then take appropriate action.



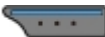

To clear the error:

Press the  button (RETRY), and then execute the retry/release operation set in [Retry Mode], or press the  button (ABORT).

 [Retry Mode](#)

To cancel an entire print job, open and close the top cover to switch the product to Offline mode, and then press the  button (CANCEL).

Cause and Countermeasure	Reference
<p>Except FeliCa</p> <p>Cause (1)</p> <p>The written value and read value do not match.</p> <p>Countermeasure (1)</p> <p>Confirm the inlay and check the product and antenna settings.</p>	<p> RFID Settings (RFID Models Only)</p> <p> RFID (RFID Models Only)</p>
<p>FeliCa only</p> <p>Cause (2)</p> <p>The written value and read value do not match. A value greater than original data was written to subtraction register.</p> <p>Countermeasure (2)</p> <p>Write an appropriate value to subtraction register.</p>	-

Contact your SATO technical support if the error cannot be resolved.

 [Contact Information for When You Are in Trouble](#)



- You cannot use an RFID tag that has caused an RFID tag error. An error message is printed on the RFID tag that caused the error.
-



Error Message 1119 (Failed to Lock the Data)

When there is an error with the product, the error message appears on the screen.

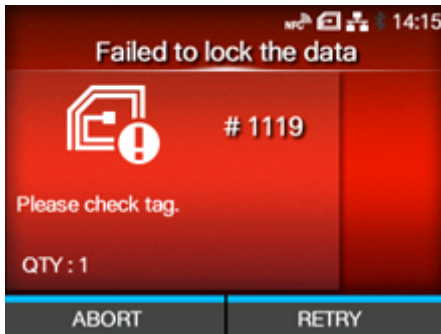
Check the cause and countermeasure, and then take appropriate action.

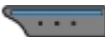

To clear the error:

Press the  button (RETRY), and then execute the retry/release operation set in [Retry Mode], or press the  button (ABORT).

 [Retry Mode](#)

To cancel an entire print job, open and close the top cover to switch the product to Offline mode, and then press the  button (CANCEL).

Cause and Countermeasure

Cause

Failed to lock the inlay.

Countermeasure

Check the inlay.

Contact your SATO technical support if the error cannot be resolved.

 [Contact Information for When You Are in Trouble](#)



- You cannot use an RFID tag that has caused an RFID tag error. An error message is printed on the RFID tag that caused the error.



Error Message 1120 (Wrong Tag UID Is Read) (CL4NX Plus Only)

When there is an error with the product, the error message appears on the screen.

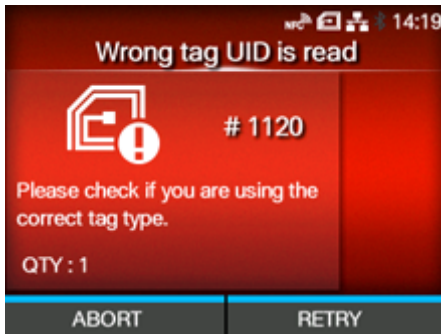
Check the cause and countermeasure, and then take appropriate action.

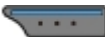

To clear the error:

Press the  button (RETRY), and then execute the retry/release operation set in [Retry Mode], or press the  button (ABORT).

 [Retry Mode](#)

To cancel an entire print job, open and close the top cover to switch the product to Offline mode, and then press the  button (CANCEL).

Cause and Countermeasure

ISO/IEC 15693, ISO/IEC 14443 Type A only

Cause

Read the UID of a tag other than the specified tag.

Countermeasure

Check that the tags you are using are the specified types of tags.

Contact your SATO technical support if the error cannot be resolved.

 [Contact Information for When You Are in Trouble](#)



- You cannot use an RFID tag that has caused an RFID tag error. An error message is printed on the RFID tag that caused the error.

Error Message 1121 (Multiple Tags Are Detected)

When there is an error with the product, the error message appears on the screen.

Check the cause and countermeasure, and then take appropriate action.

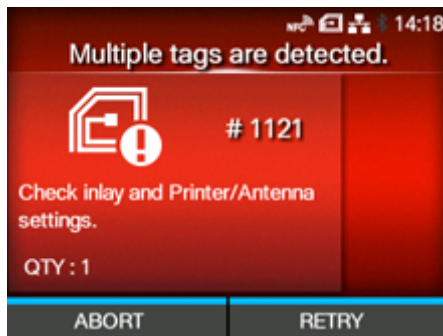



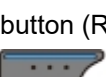

To clear the error:

Press the  button (RETRY), and then execute the retry/release operation set in [Retry Mode], or press the  button (ABORT).

 [Retry Mode](#)

To cancel an entire print job, open and close the top cover to switch the product to Offline mode, and then press the  button (CANCEL).

Cause and Countermeasure	Reference
<p>Except FeliCa</p> <p>Cause (1)</p> <p>Multiple inlays captured at same time.</p> <p>Countermeasure (1)</p> <p>Confirm the inlay and check the product and antenna settings.</p>	<p> RFID Settings (RFID Models Only)</p> <p> RFID (RFID Models Only)</p>
<p>FeliCa only</p> <p>Cause (2)</p> <p>The IDms of the cards captured between processes are not the same (tried to write unintended card).</p> <p>Countermeasure (2)</p> <p>Confirm the inlay and check the product and antenna settings.</p>	<p> RFID Settings (RFID Models Only)</p> <p> RFID (RFID Models Only)</p>

Contact your SATO technical support if the error cannot be resolved.

 [Contact Information for When You Are in Trouble](#)



- You cannot use an RFID tag that has caused an RFID tag error. An error message is printed on the RFID tag that caused the error.
-



Error Message 1123 (Write Tag Error)

When there is an error with the product, the error message appears on the screen.

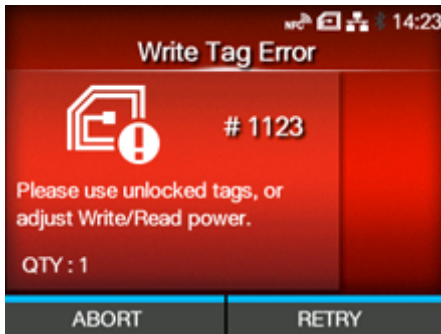
Check the cause and countermeasure, and then take appropriate action.



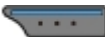

To clear the error:

Press the  button (RETRY), and then execute the retry/release operation set in [Retry Mode], or press the  button (ABORT).

 [Retry Mode](#)

To cancel an entire print job, open and close the top cover to switch the product to Offline mode, and then press the  button (CANCEL).

Cause and Countermeasure	Reference
<p>UHF only</p> <p>Cause (1)</p> <p>Tried to write to an inlay that was write-locked.</p> <p>Countermeasure (1)</p> <p>Use tags that are not locked.</p>	-
<p>UHF only</p> <p>Cause (2)</p> <p>Tried to write to an inlay when the writing power is low.</p> <p>Countermeasure (2)</p> <p>Adjust [Write Power]/[Read Power].</p>	<p> Write Power</p> <p> Read Power</p>

Contact your SATO technical support if the error cannot be resolved.

 [Contact Information for When You Are in Trouble](#)



- You cannot use an RFID tag that has caused an RFID tag error. An error message is printed on the RFID tag that caused the error.



Error Message 1124 (Wrong Tag Type) (CL4NX Plus Only)

When there is an error with the product, the error message appears on the screen.

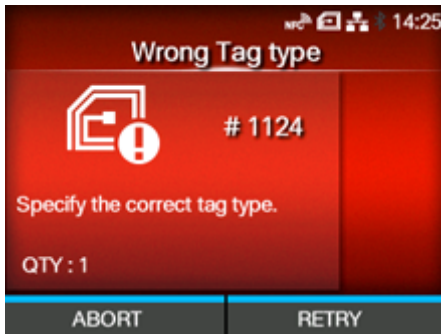
Check the cause and countermeasure, and then take appropriate action.



To clear the error:

Press the  button (RETRY), and then execute the retry/release operation set in [Retry Mode], or press the  button (ABORT).

 [Retry Mode](#)

To cancel an entire print job, open and close the top cover to switch the product to Offline mode, and then press the  button (CANCEL).

Cause and Countermeasure

ISO/IEC 15693, ISO/IEC 14443 Type A only

Cause

Incorrect tag type is specified.

Countermeasure

Check the tag type, and specify the correct tag type.

Contact your SATO technical support if the error cannot be resolved.

 [Contact Information for When You Are in Trouble](#)



- You cannot use an RFID tag that has caused an RFID tag error. An error message is printed on the RFID tag that caused the error.



Error Message 1125 (Internal Error) (CL4NX Plus Only)

When there is an error with the product, the error message appears on the screen.

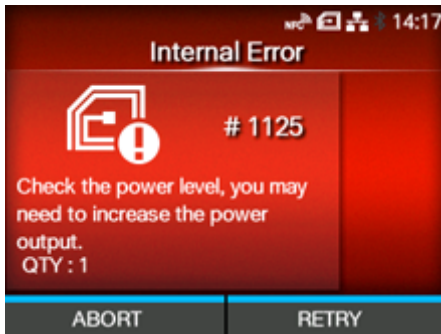
Check the cause and countermeasure, and then take appropriate action.

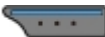

To clear the error:

Press the  button (RETRY), and then execute the retry/release operation set in [Retry Mode], or press the  button (ABORT).

 [Retry Mode](#)

To cancel an entire print job, open and close the top cover to switch the product to Offline mode, and then press the  button (CANCEL).

Cause and Countermeasure

ISO/IEC 15693, ISO/IEC 14443 Type A, FeliCa only

Cause

Failed to acquire the ID.

Countermeasure

The radio wave condition needs to be improved.

Contact your SATO technical support if the error cannot be resolved.

 [Contact Information for When You Are in Trouble](#)



- You cannot use an RFID tag that has caused an RFID tag error. An error message is printed on the RFID tag that caused the error.



Error Message 1126 (Not Enough Power)

When there is an error with the product, the error message appears on the screen.

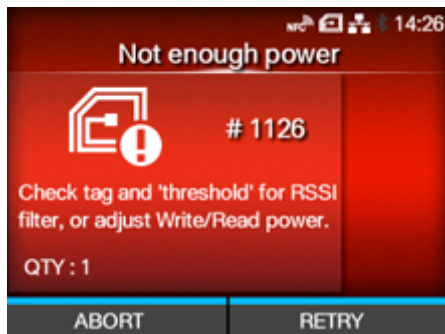
Check the cause and countermeasure, and then take appropriate action.





To clear the error:

Press the  button (RETRY), and then execute the retry/release operation set in [Retry Mode], or press the  button (ABORT).

 [Retry Mode](#)

To cancel an entire print job, open and close the top cover to switch the product to Offline mode, and then press the  button (CANCEL).

Cause and Countermeasure	Reference
<p>UHF only</p> <p>Cause</p> <p>The [RSSI Filter] function is enabled, and the RSSI value of the inlay is lower than the values set in [Threshold Value].</p> <p>Countermeasure</p> <ul style="list-style-type: none"> ◦ Check the tags. Or, check the [Threshold Value] settings. ◦ Adjust [Write Power]/[Read Power]. 	<p> Threshold Value</p> <p> Write Power</p> <p> Read Power</p>

Contact your SATO technical support if the error cannot be resolved.

 [Contact Information for When You Are in Trouble](#)

-
-  • You cannot use an RFID tag that has caused an RFID tag error. An error message is printed on the RFID tag that caused the error.
-



Error Message 1131 (Exceed Address Error) (CL4NX Plus Only)

When there is an error with the product, the error message appears on the screen.

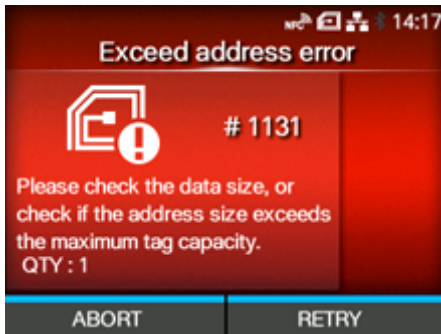
Check the cause and countermeasure, and then take appropriate action.



To clear the error:

Press the  button (RETRY), and then execute the retry/release operation set in [Retry Mode], or press the  button (ABORT).

 [Retry Mode](#)

To cancel an entire print job, open and close the top cover to switch the product to Offline mode, and then press the  button (CANCEL).

Cause and Countermeasure

ISO/IEC 15693 only

Cause

- Tried to write the data to the memory which exceeds the address range.
- The memory does not exist in the memory block address where the data should be written.

Countermeasure

- Check if the address size exceeds the maximum inlay capacity.
- Check the data size.

Contact your SATO technical support if the error cannot be resolved.

 [Contact Information for When You Are in Trouble](#)



- You cannot use an RFID tag that has caused an RFID tag error. An error message is printed on the RFID tag that caused the error.

Error Message 1133 (SRA Motor Unit Error)

When there is an error with the product, the error message appears on the screen.

Check the cause and countermeasure, and then take appropriate action.

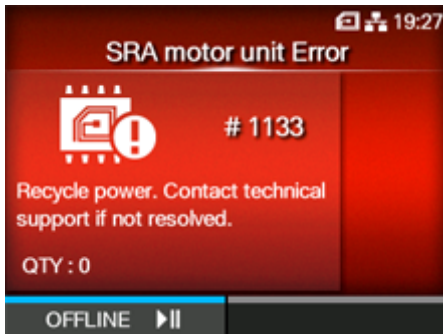

To clear the error:

Press the  button (OFFLINE).

Cause and Countermeasure	Reference
<p>Cause</p> <p>SATO RF Analyze (SRA) motor unit is not operating correctly.</p> <p>Countermeasure</p> <p>A replacement of the RFID module is required. Contact your SATO technical support.</p>	<p> Contact Information for When You Are in Trouble</p>

Error Message 1135 (Unsupported Option Error)



When there is an error with the product, the error message appears on the screen.

Check the cause and countermeasure, and then take appropriate action.



To clear the error:

Power off the product.

Cause and Countermeasure	Reference
<p>Cause</p> <p>An unsupported optional device is installed.</p> <p>Countermeasure</p> <p>Power off the product, and then remove the optional device.</p>	<p> Powering On/Off the Product</p> <p> Optional Devices</p>

Contact your SATO technical support if the error cannot be resolved.

 [Contact Information for When You Are in Trouble](#)



Error Message Indication and Operating Procedure When the SOS (SATO Online Services) Is Enabled (SOS users only)

The SOS (SATO Online Services) icon appears in the error message when SOS is enabled.

If you select the SOS icon, a QR code containing the error information and the contact telephone number appears.

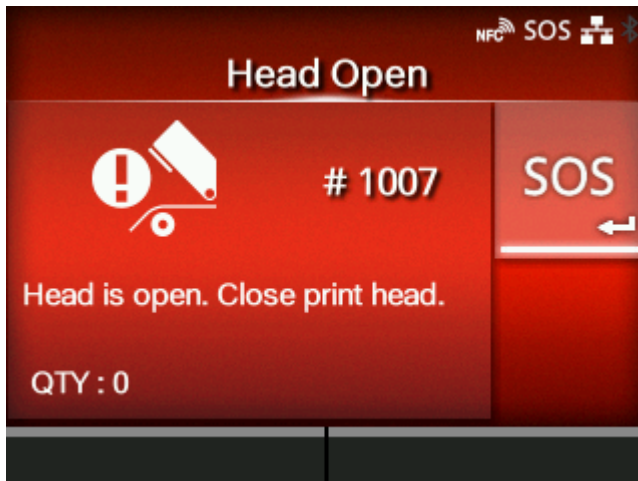
- Press the  button.



- If the icon of the guidance videos also appears, select the SOS icon using the  /  button, and then press the  button.



A screen with QR code, phone number, serial number, and error number appears after selecting the SOS icon and pressing the  button.

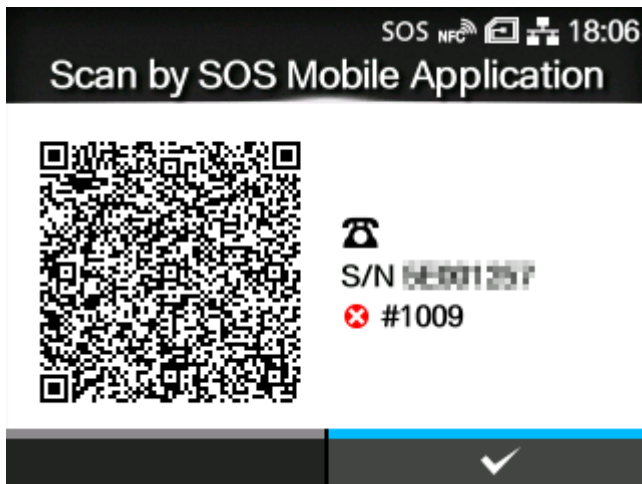

Scan the QR code with the specialized SOS application from a tablet device or smartphone. After scanning the QR code, the menu for the specialized SOS application appears.

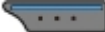
Press the  button to return to the error message screen.

Also, the product information can be acquired via NFC and sent to the SOS cloud.

Contact Information for When You Are in Trouble

Contact Us

Access the following site to send us your questions or comments.

 <https://www.sato-global.com/contact/>

Product Specifications

Hardware

Dimensions and Weight

Item	CL4NX Plus	CL6NX Plus
Width	271 mm (10.67") (Excludes projection)	338 mm (13.31") (Excludes projection)
Height	321 mm (12.64") (Excludes projection)	321 mm (12.64") (Excludes projection)
Depth	457 mm (18.00") (Excludes projection)	457 mm (18.00") (Excludes projection)
Weight	Approximately 15.1 kg (33.28 lbs.) (Excludes media, ribbon and options)	Approximately 20.3 kg (44.75 lbs.) (Excludes media, ribbon and options)

Power Supply

Item	CL4NX Plus	CL6NX Plus
Input Voltage	AC 100 - 240 V \pm 10% (Full-range)	
Frequency	50 / 60 Hz	
Power Consumption	<p>Input voltage conditions: AC 100 V, 50 Hz (Dispenser specifications)</p> <p>At peak 190 W / 205 VA (Print ratio 30%)</p> <p>Standby 20 W / 25 VA</p> <p>Input voltage conditions: AC 230 V, 50 Hz (Dispenser specifications)</p> <p>At peak 195 W / 210 VA (Print ratio 30%)</p> <p>Standby 20 W / 40 VA</p>	<p>Input voltage conditions: AC 100 V, 50 Hz (Dispenser specifications)</p> <p>At peak 270 W / 275 VA (Print ratio 30%)</p> <p>Standby 24 W / 29 VA</p> <p>Input voltage conditions: AC 230 V, 50 Hz (Dispenser specifications)</p> <p>At peak 260 W / 280 VA (Print ratio 30%)</p> <p>Standby 24 W / 61 VA</p>

Processing

Item	CL4NX Plus	CL6NX Plus
Flash ROM	CPU1 2 GB CPU2 4 MB	
SDRAM	CPU1 256 MB CPU2 64 MB	
User Registration Area	Maximum 679 MB	
Receive Buffer	Buffer full 2.95 MB Buffer near full Occurrence: 2MB, Release: 1 MB	

Operation

Item	CL4NX Plus	CL6NX Plus
LCD	TFT color 3.5-inch (88.9 mm)	
LED	STATUS Blue/Red	
Display Language	English / German / French / Spanish / Italian / Portuguese / Brazilian Portuguese / Czech / Danish / Dutch / Finnish / Greek / Hungarian / Norwegian / Polish / Romanian / Russian / Slovak / Swedish / Turkish / Chinese (Simplified) / Chinese (Traditional) / Korean / Japanese / Arabic / Thai / Vietnamese / Persian / Indonesian / Hindi / Bulgarian	

Environmental Conditions (Without Media and Ribbon)

Item	CL4NX Plus	CL6NX Plus
Operating Temperature	Continuous/Cutter/Tear-off mode 0 to 40 °C (32 to 104 °F) Dispenser/Linerless mode 5 to 35 °C (41 to 95 °F)	Continuous/Cutter/Tear-off mode 0 to 40 °C (32 to 104 °F) Dispenser mode 5 to 35 °C (41 to 95 °F)

Item	CL4NX Plus	CL6NX Plus
Storage Temperature	-20 to 60 °C (-4 to 140 °F)	
Operating Humidity	Continuous/Dispenser/Cutter/ Tear-off mode 30 to 80% RH (Non-condensing) Linerless mode 30 to 75% RH (Non-condensing)	30 to 80% RH (Non-condensing)
Storage Humidity	30 to 90% RH (Non-condensing)	

Print

Item	CL4NX Plus	CL6NX Plus
Print Method	Direct thermal and thermal transfer	
Print Speed	203 dpi/305 dpi 2 to 14 inches/sec (50.8 to 355.6 mm/sec) * The max speed when using dispenser mode is 10 ips (inches/sec) (254 mm/sec) 609 dpi 2 to 6 inches/sec (50.8 to 152 mm/sec) Linerless mode 2 to 6 inches/sec (50.8 to 152 mm/sec)	203 dpi 2 to 10 inches/sec (50.8 to 254 mm/sec) 305 dpi 2 to 8 inches/sec (50.8 to 203.2 mm/sec)
Resolution (Head Density)	<ul style="list-style-type: none"> • 203 dpi (8 dots/mm) • 305 dpi (12 dots/mm) • 609 dpi (24 dots/mm) 	<ul style="list-style-type: none"> • 203 dpi (8 dots/mm) • 305 dpi (12 dots/mm)
Non-printable Area	Pitch direction (Excludes liner) Top 1.5 mm (0.06") Bottom 1.5 mm (0.06") Width direction (Excludes liner) Left 1.5 mm (0.06")	

Item	CL4NX Plus	CL6NX Plus
	Right 1.5 mm (0.06") <hr/>  <ul style="list-style-type: none"> For RFID models, printing around the chip or on the antenna may be limited by the layout. <hr/>	
Printable Area	203 dpi Length 2500 mm (98.42") x Width 104 mm (4.09") 305 dpi Length 1500 mm (59.05") x Width 104 mm (4.09") 609 dpi Length 400 mm (15.75") x Width 104 mm (4.09")	203 dpi Length 2500 mm (98.42") x Width 152 mm (5.98") 305 dpi Length 1500 mm (59.05") x Width 165.3 mm (6.50") When Head Base Position is set to Left-justify maximum print width 167.5 mm (6.59")
Print End Position	203 dpi (1 dot = 0.125 mm (0.0049")) 1 to 20000 dots 305 dpi (1 dot = 0.083 mm (0.0033")) 1 to 18000 dots 609 dpi (1 dot = 0.042 mm (0.0017")) 1 to 9600 dots	203 dpi (1 dot = 0.125 mm (0.0049")) 1 to 20000 dots 305 dpi (1 dot = 0.083 mm (0.0033")) 1 to 18000 dots
Print Darkness	Darkness level 1 to 10 Darkness range A	

Sensors

Item	CL4NX Plus	CL6NX Plus
I-mark (Reflective Type)	Position and sensitivity Adjustable	

Item	CL4NX Plus	CL6NX Plus
Gap (Transmissive Type)	Position and sensitivity Adjustable	
Head Open	Fixed	
Paper End Sensor	Detect with I-mark sensor or Gap sensor	
Label Near End	Fixed	
Ribbon End/Ribbon Near End	Fixed	
Dispenser	Fixed <ul style="list-style-type: none"> If linerless cutter kit or dispenser unit is installed. 	Fixed <ul style="list-style-type: none"> If dispenser unit is installed.
Cutter	Fixed <ul style="list-style-type: none"> If cutter unit, linerless cutter kit, or rotary cutter unit is installed. 	Fixed <ul style="list-style-type: none"> If cutter unit is installed.



- Specifications are subject to change without notice.
-

Interface

Supported Interfaces

For data communication with the host, the product supports the following interfaces.

Standard

- USB Interface (Type B)
- LAN Interface (Ethernet)
- Bluetooth Interface
- NFC Interface
- USB Interface (Type A) x 2
- RS-232C Interface (DB 9 pins, female)
- IEEE1284 Interface (Amphenol 36 pins)
- External Signal (EXT) Interface (Amphenol 14 pins)

Option

- Wireless LAN Interface

RFID (RFID models only)

UHF (920 MHz)

ISO/IEC 18000-6 Type C Gen2

HF (13.56 MHz) (CL4NX Plus only)

ISO/IEC 15693 (ICODE SLI/SLIX/SLIX-S, Tag-it HF-I, my-d)

ISO/IEC 14443 Type A (NTAG203, NTAG210/213/215/216, MIFARE UltraLight, MIFARE UltraLight C, my-d move NFC)

ISO/IEC 18092 (FeliCa Lite-S)



- Do not connect or disconnect the interface cables (or use a switch box) with power supplied to either the product or host. This may cause damage to the interface circuitry in the product or host and is not covered by warranty.
-



- Wireless LAN is an optional interface.
 - You cannot use the wireless LAN interface and LAN interface at a time.
 - You can set the interface settings of the product through [Interface] in the [Settings] menu.
-

USB Interface

This interface complies with the USB 2.0 standard.

Install the USB driver to the computer before use.

Basic Specifications	
Connector	USB Type B connector
Protocol	<ul style="list-style-type: none">• STATUS4• STATUS5
Power Supply	BUS Power through cable

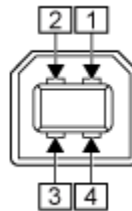

Pin Assignments	
Pin No.	Description
1	VBus
2	-Data
3	+Data
4	GND

Cable Specifications	
Cable Connector	USB Type B connector
Cable Length	5 m (16.4 feet) or less



• Specifications are subject to change without notice.

LAN Interface

Basic Specifications	
Connector	RJ-45 Receptacle
Protocol	<ul style="list-style-type: none"> • Status3 • Status4 • Status5
IP Address	<ul style="list-style-type: none"> • IPv4 • IPv6
Subnet Mask / Prefix Length	<ul style="list-style-type: none"> • IPv4 • IPv6
Gateway Address	<ul style="list-style-type: none"> • IPv4 • IPv6

Cable Specifications	
Cable	10BASE-T/100BASE-TX Category 5
Cable Length	100 m (328 feet) or less

Software Specifications	
Supported Protocol	TCP/IP
Network Layer	<ul style="list-style-type: none"> • IP • ICMP
Session Layer	<ul style="list-style-type: none"> • TCP
Application Layer	<ul style="list-style-type: none"> • LPD • FTP • DHCP • HTTP/HTTPS • SNMP • NTP



- Specifications are subject to change without notice.

Bluetooth Interface

This interface complies with the Bluetooth 3.0+EDR standard.

Basic Specifications	
Signal Level	Class 2
Communication Distance	10 m (32.8 feet)
Profile	<ul style="list-style-type: none">Serial Port Profile (SPP)
Security Level	<ul style="list-style-type: none">Nonelevel 2-1level 2-2level 3level 4
PIN Code	1 to 16 characters consisting of ASCII code (20H, 21H, 23H to 7EH)
Disconnect Timeout (LMP Layer)	60 seconds



- Specifications are subject to change without notice.
-

NFC Interface

This interface complies with the NFC Forum Type 2 Tag.



- Specifications are subject to change without notice.
-

RS-232C Interface

This interface complies with the RS-232C standard.

Basic Specifications	
Asynchronous ASCII	Half-duplex communication Bi-directional communication
Data Transmission Rate	2400, 4800, 9600, 19200, 38400, 57600, 115200 bps
Transmission Form	Start, b1, b2, b3, b4, b5, b6, b7, b8, Stop  • "b8" will be omitted if using 7 bit oriented.
Data Length	7 or 8 bits (Selected)
Stop Bit	1 or 2 bits (Selected)
Parity Bit	ODD, EVEN, NONE (Selected)
Codes Used	ASCII Character Codes 7 bits Graphics 8 bits
Control Codes	STX (02H), ETX (03H), ACK (06H), NAK (15H)
Connector	DB-9 Female or equivalent
Signal Level	High = +5 to +12 V, Low = -5 to -12 V
Protocol	<ul style="list-style-type: none"> • READY/BUSY • XON/XOFF • STATUS3 • STATUS4 • STATUS5

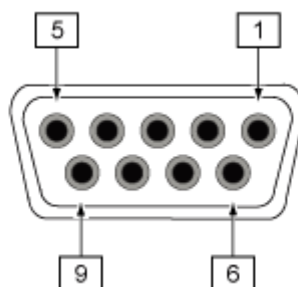

Connector Pin Specifications		
Pin No.	I/O	Description
1	-	Data Carrier Detect
2	Input	Receive Data
3	Output	Transmit Data
4	Output	Data Terminal Ready
5	Reference	Signal Ground
6	Input	Data Set Ready
7	Output	Request To Send
8	Input	Clear To Send
9	-	Not connected

Cable Specifications	
Cable Connector	DB-9 Male or equivalent
Cable Length	5 m (16.4 feet) or less



- When using the READY/BUSY control, make sure that the product is in power on mode before you send the data from the host.
- With communication protocols such as XON/XOFF, STATUS3, STATUS4 or STATUS5, a receive buffer full error will occur when the received data is more than the receive buffer size (2.95 MB). When sending data, monitor the status of the product and keep the size of the data that is sent to less than 2.95 MB.
- A parity error is detected when an error occurs after receiving the start code <A> command.
- Specifications are subject to change without notice.

IEEE1284 Interface

This interface complies with the IEEE1284 standard.

Basic Specifications	
Connector	Amphenol 36 pins, female
Signal Level	High-level +2.4 to +5.0 V Low-level +0.0 to +0.4 V
Receive Mode	Single-item buffer, Multi-item buffer

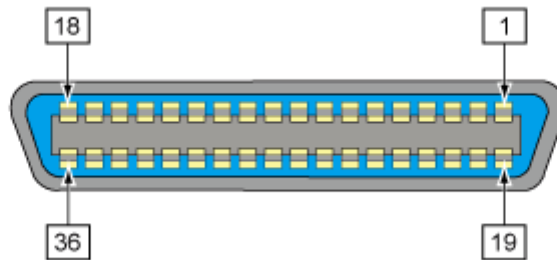

Connector Pin Specifications		
Pin No.	I/O	Description
1	Input	STROBE
2 - 9	Input	DATA 1 - DATA 8 DATA1 LSB DATA8 MSB
10	Output	ACK
11	Output	BUSY
12	Output	PAPER EMPTY/PAPER ERROR
13	Output	SELECT
14	Input	AUTO FEED
15	-	Not in use

Connector Pin Specifications		
Pin No.	I/O	Description
16	-	LOGIC Ground
17	-	Frame Ground
18	-	+5 V
19	-	STROBE RETURN
20-27	-	DATA 1 - DATA 8 RETURN
28	-	ACK RETURN
29	-	BUSY RETURN
30	-	PAPER EMPTY RETURN
31	Input	INITIALIZE
32	Output	FAULT
33-35	-	Not in use
36	Input	SELECT INPUT

Cable Specifications	
Cable Connector	Amphenol 36 pins, male
Cable Length	1.5 m (5 feet) or less



- Specifications are subject to change without notice.
-

External Signal (EXT) Interface

Basic Specifications of External Signal (EXT) Interface

This interface is designed to connect the product with other peripherals.

Basic Specifications	
Connector	Centronics IDC Type 14 pins (Female)
Signal Levels	High-level +4.2 to +5.0 V Low-level +0.0 to +0.7 V

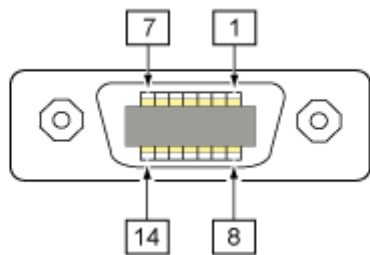

Connector Pin Specifications of External Signal (EXT) Interface

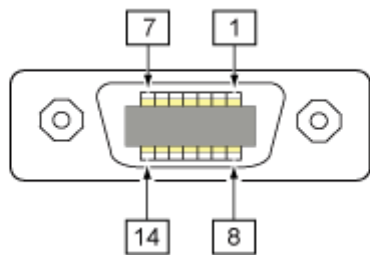

Pin No.	I/O	Description	Electric Conditions (Voltage, Current (Max))
1	Output	Paper End Outputs a low signal when the paper end is detected.	Withstand voltage 50 V Sink current 50 mA
2	-	GND Reference Signal Ground	-

Pin No.	I/O	Description	Electric Conditions (Voltage, Current (Max))
3	Output	Ribbon End Outputs a low signal when the ribbon end is detected.	Withstand voltage 50 V Sink current 50 mA
4	Output	Machine Error Outputs a low signal when an error such as the head open error is detected.	Withstand voltage 50 V Sink current 50 mA
5	Input	Print Start signal (PRIN) Prints one media when a low signal is detected.	High: high impedance Low: more than -15 mA, 0 V
6	Output	Print Done/Print End signal (PREND) Outputs a signal when the media print is completed.	Withstand voltage 50 V Sink current 50 mA
7	Input	Reprint signal (PRIN2) Prints the previously printed content again when a low signal is detected.	High: high impedance Low: more than -15 mA, 0 V
8	Input	External power supply	5 V
9	Output	Offline Outputs a low signal when the product is in Offline mode.	Withstand voltage 50 V Sink current 50 mA
10	Output	Ribbon Near End Outputs a high signal when the ribbon near end is detected.	Withstand voltage 50 V Sink current 50 mA
11	-	-	-
12	-	+24 V \pm 10%	2 A
13	-	Vcc +5 V	500 mA
14	-	-	-

Pin No.	I/O	Description	Electric Conditions (Voltage, Current (Max))
*	Output	<p>Wait signal for dispense completion</p> <p>Outputs a low signal when the dispense is completed.</p> <p>You can set the pin number for output through the [Settings] > [Interface] > [External I/O] > [Signals] > [Outputs] menu.</p>	<p>Withstand voltage 50 V</p> <p>Sink current 50 mA</p>
*	Output	<p>Label Near End signal</p> <p>Outputs a high signal when the label near end is detected.</p> <p>You can set the pin number for output through the [Settings] > [Interface] > [External I/O] > [Signals] > [Outputs] menu.</p>	<p>Withstand voltage 50 V</p> <p>Sink current 50 mA</p>



- You can set the external signal (EXT) type (TYPE1 to TYPE4) for Print Done output signal of pin No. 6. Refer to the [EXT Mode] screen of the [Settings] > [Interface] > [External I/O] > [Signals] menu for details.
- You can set the pin number for input and output through the [Settings] > [Interface] > [External I/O] > [Signals] > [Inputs] and [Outputs] menu.
- The Print Done signal of pin No. 6 is not outputted when 0 is specified in the number of cuts in the command specifying the number of cuts during the cutter operation.

Timing Chart of the EXT Input Signal

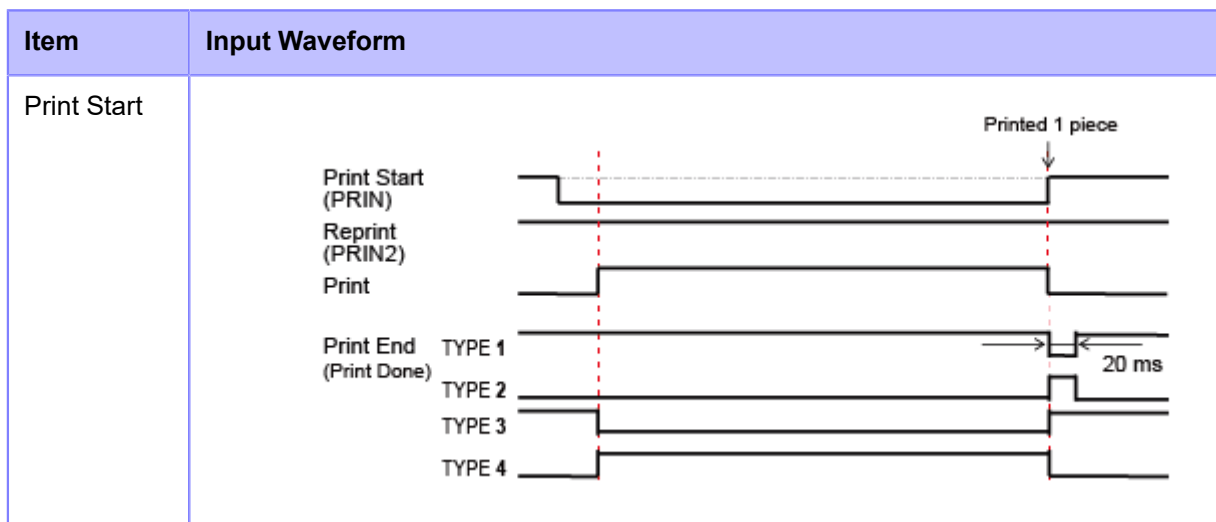

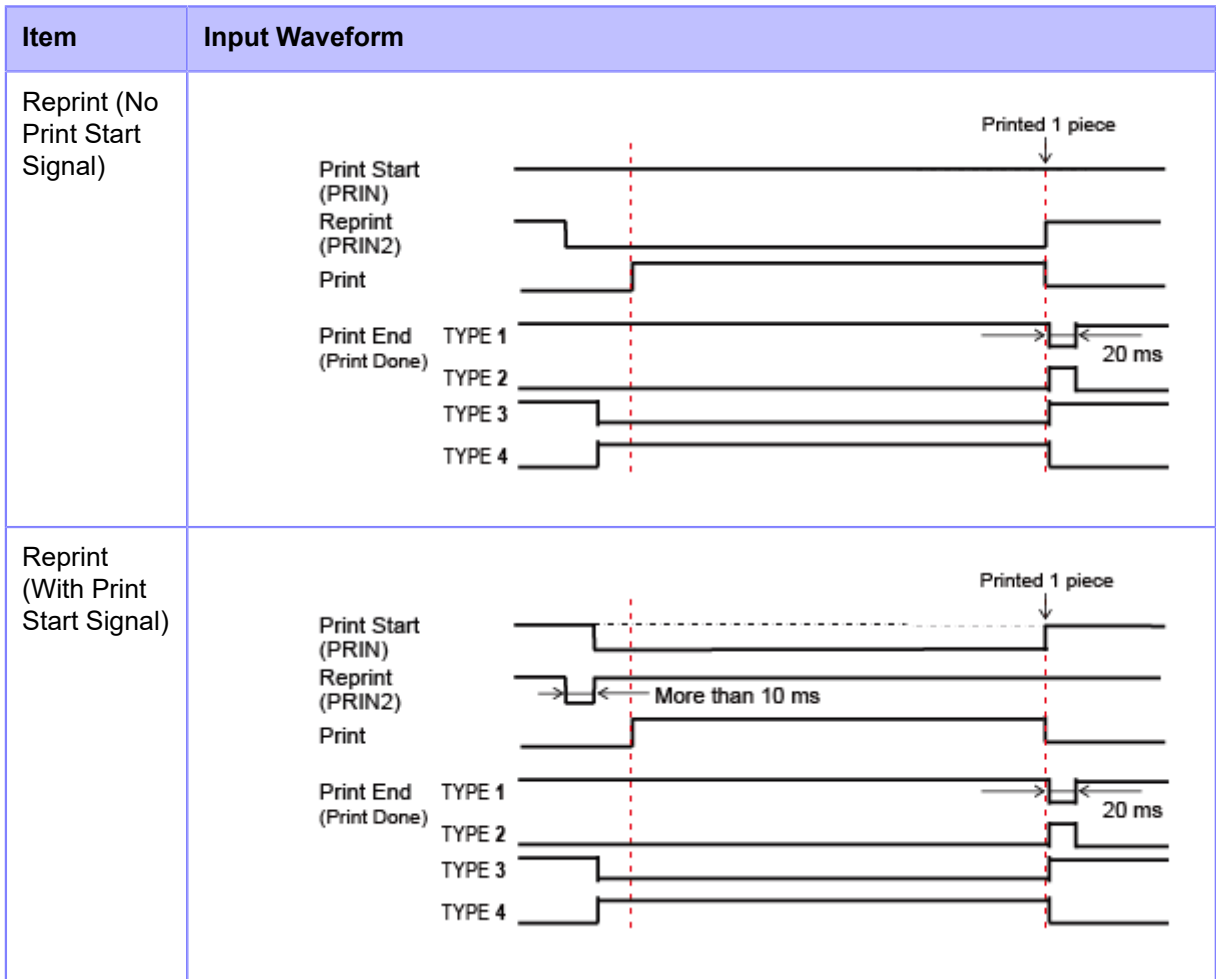

- Keep the print start signal (PRIN) to "Low" until the print end signal (Print done) is outputted. For maintaining the print start signal (PRIN), refer to the [Maintaining the Print Start Signal \(PRIN\)](#).
- Keep the output reprint signal (PRIN2) for more than 10 ms. When signal is outputted for shorter than 10 ms, and reprint signal is not acknowledged, the product does not perform reprinting.

Maintaining the Print Start Signal (PRIN)

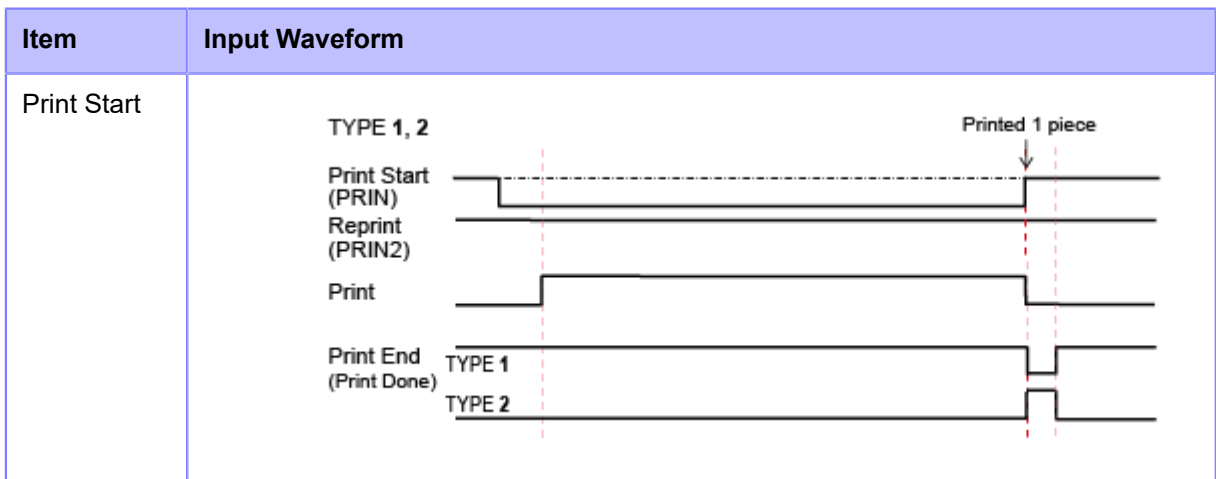

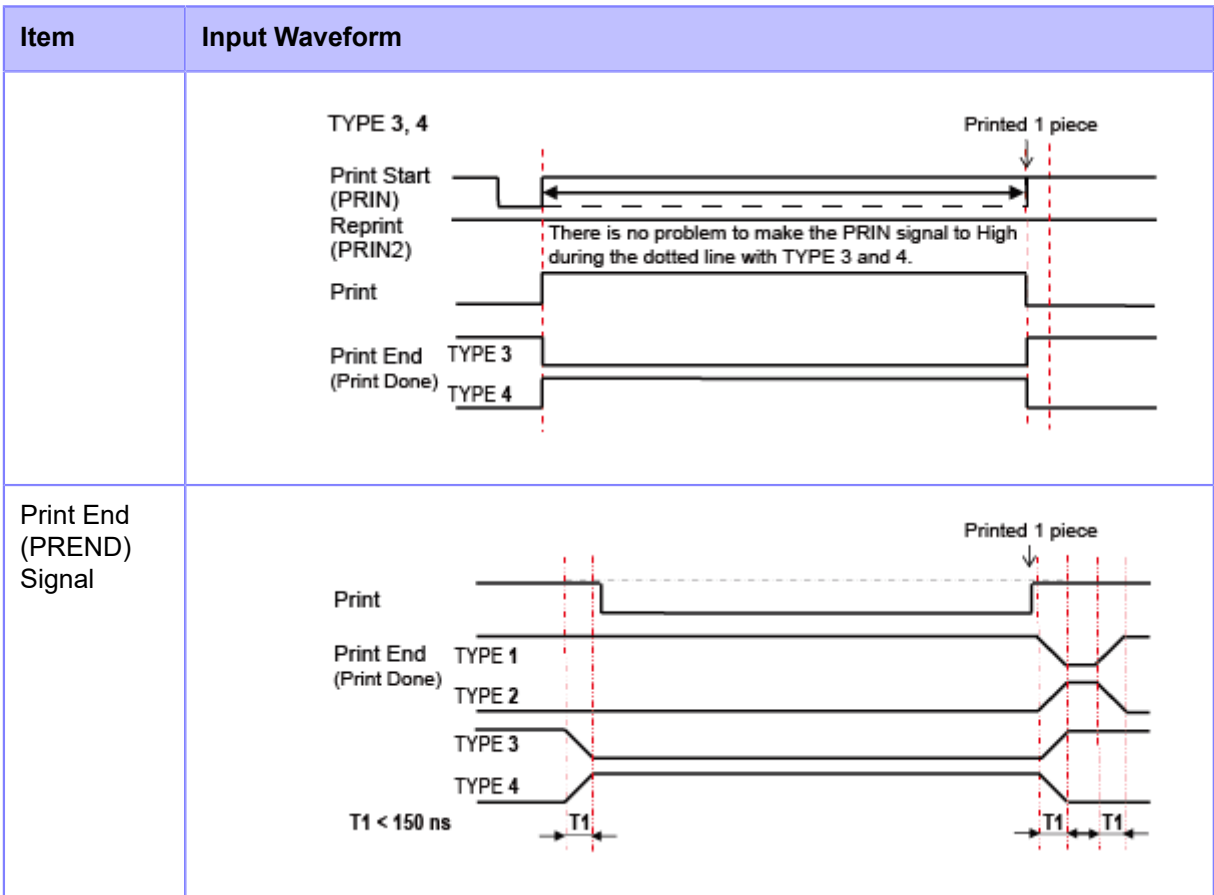

- Rise or fall time ($T1$) of Print Done signal is less than 150 ns. You have to consider the time when outputting the signal from the connected devices.
- When the print start signal and reprint signal are outputted simultaneously, the print start signal is enabled and the product does not perform reprinting.
- The reprint signal is valid only from the time of the print operation end ($QTY=0$) until the next print data reception. Other than that, the product does not perform reprinting.

Timing Chart of the EXT Output Signal

Standard Specification

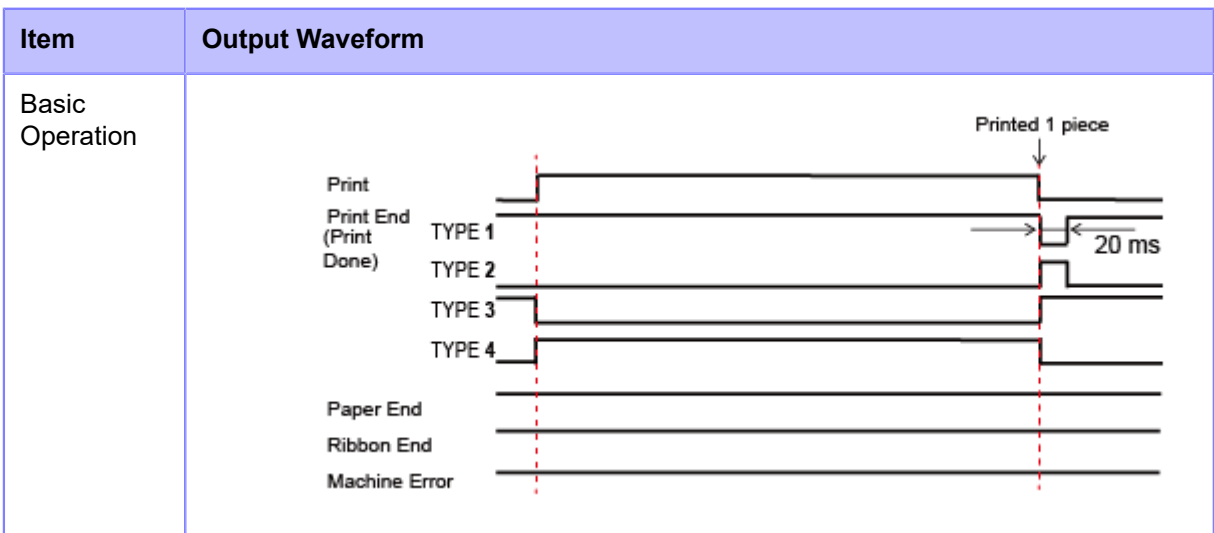

Item	Output Waveform
Paper End	<p>The timing chart for the Paper End event shows the following signal behavior:</p> <ul style="list-style-type: none"> Print: A pulse that starts before Paper End and ends at Paper End. Print End (TYPE 1, 2, 3, 4): Four different pulse shapes, all starting before Paper End and ending at Paper End. Paper End: A pulse that starts at Paper End and ends at Head Close. Ribbon End: A pulse that starts at Paper End and ends at Head Close. Machine Error: A pulse that starts at Head Open and ends at Head Close. Key Events: Paper End, Head Open, and Head Close are marked with vertical dashed lines and arrows. Replace Media: A horizontal double-headed arrow indicating the duration from Paper End to Head Close.
Ribbon End	<p>The timing chart for the Ribbon End event shows the following signal behavior:</p> <ul style="list-style-type: none"> Print: A pulse that starts before Ribbon End and ends at Ribbon End. Print End (TYPE 1, 2, 3, 4): Four different pulse shapes, all starting before Ribbon End and ending at Ribbon End. Paper End: A pulse that starts at Ribbon End and ends at Head Close. Ribbon End: A pulse that starts at Ribbon End and ends at Head Close. Machine Error: A pulse that starts at Head Open and ends at Head Close. Key Events: Ribbon End, Head Open, and Head Close are marked with vertical dashed lines and arrows. Replace Ribbon: A horizontal double-headed arrow indicating the duration from Ribbon End to Head Close.
Machine Error	<p>The timing chart for the Machine Error event shows the following signal behavior:</p> <ul style="list-style-type: none"> Print: A pulse that starts before Head Open and ends at Head Open. Print End (TYPE 1, 2, 3, 4): Four different pulse shapes, all starting before Head Open and ending at Head Open. Paper End: A pulse that starts at Head Open and ends at Head Close. Ribbon End: A pulse that starts at Head Open and ends at Head Close. Machine Error: A pulse that starts at Head Open and ends at Head Close. Key Events: Head Open and Head Close are marked with vertical dashed lines and arrows.

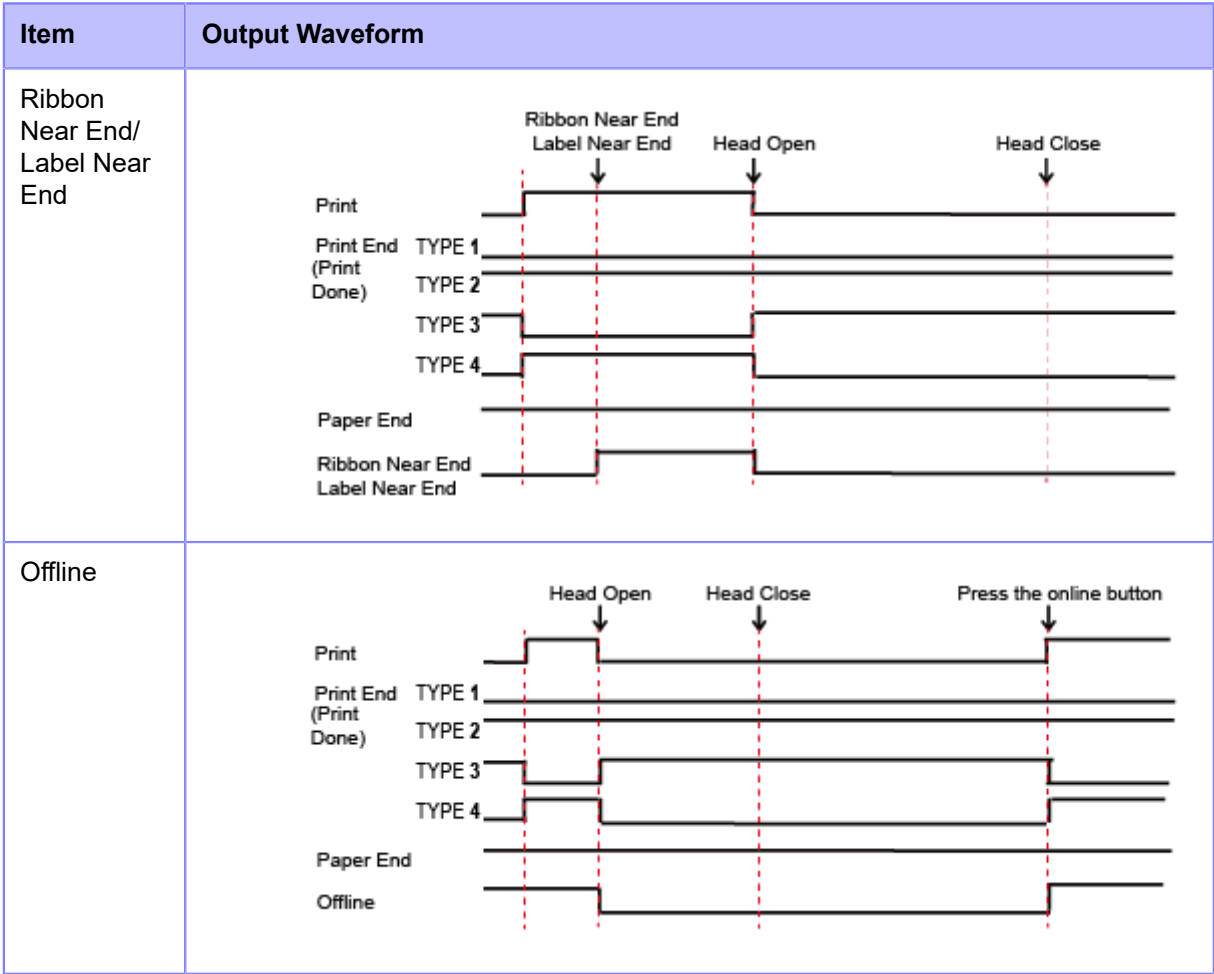

If RFID Mode Is Enabled (RFID models only)

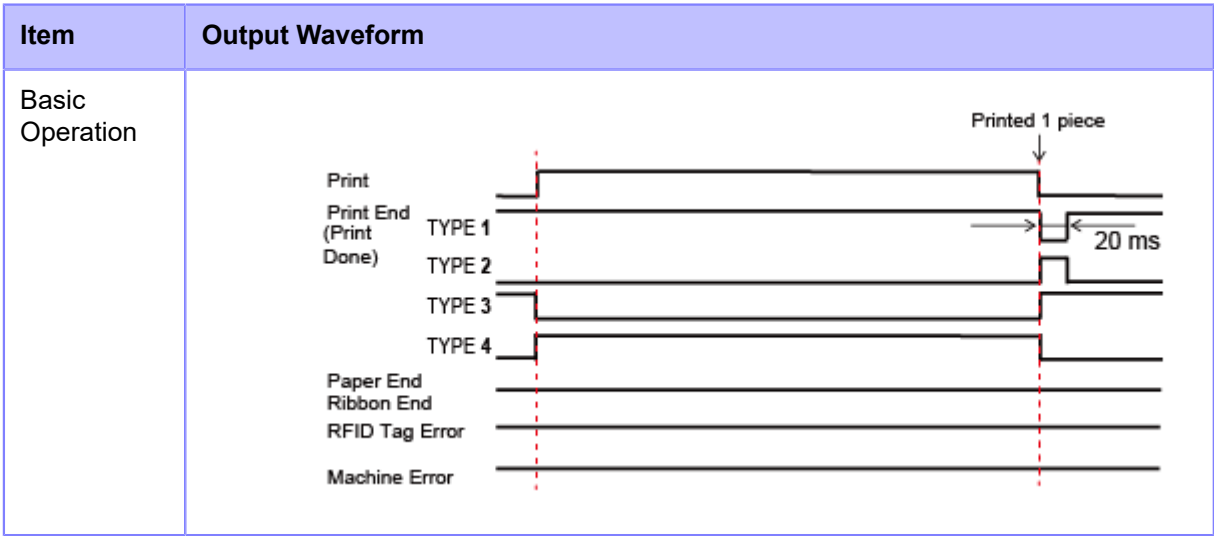

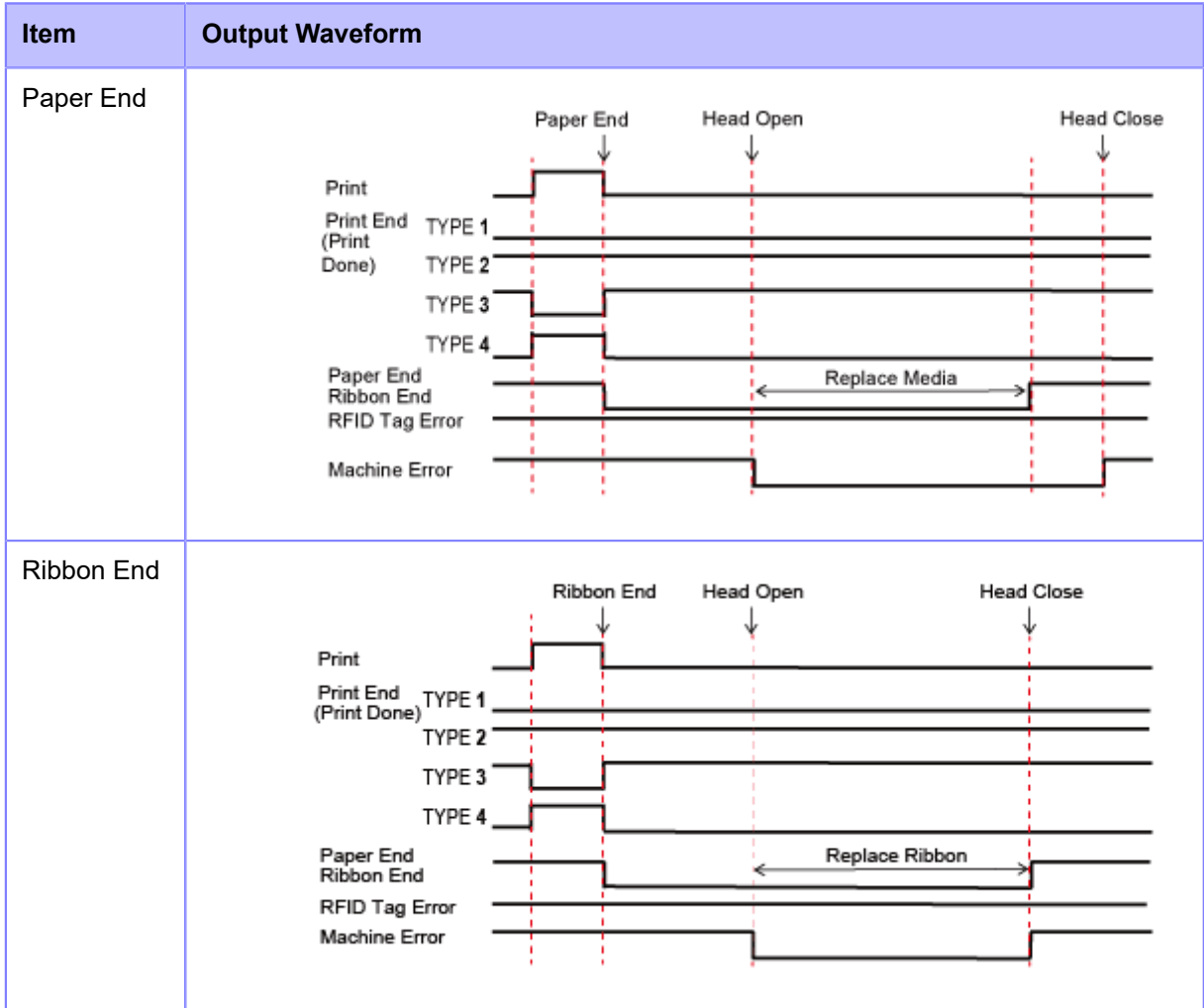

Timing Chart of the Wait Signal for Dispense Completion

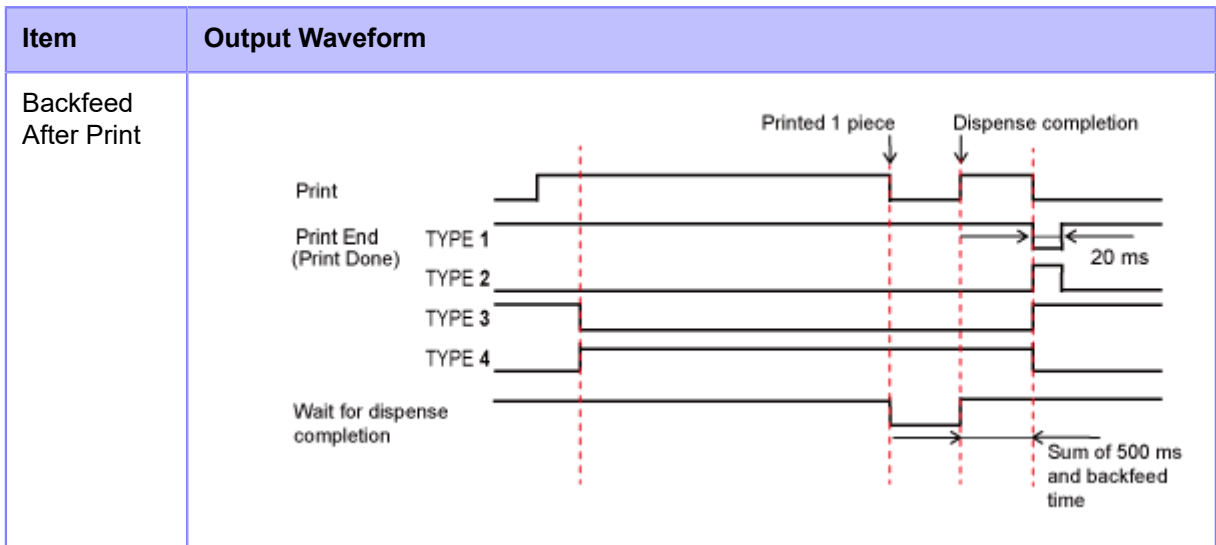

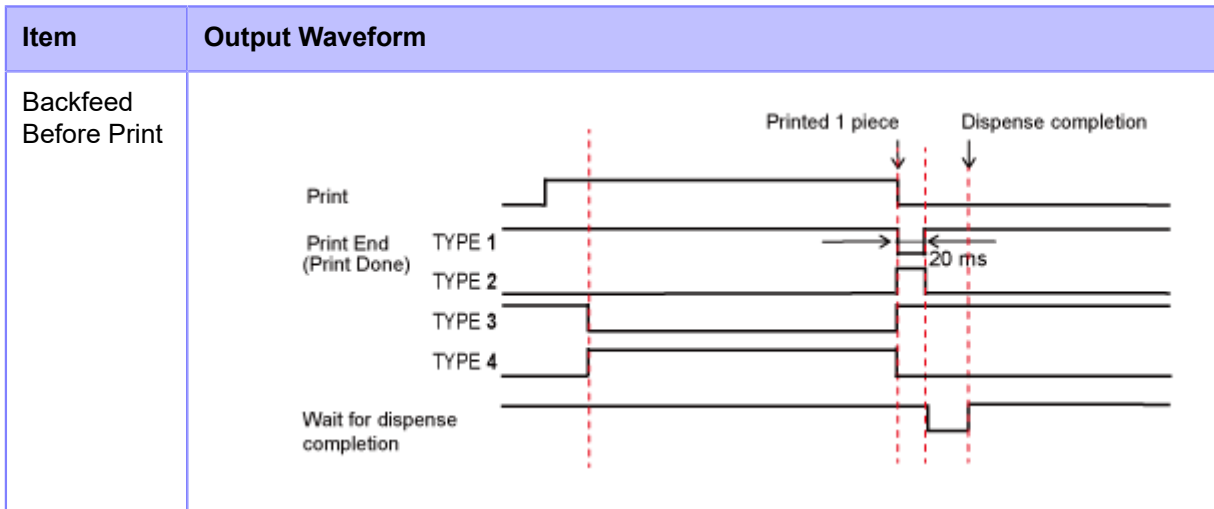

1. When the wait signal for dispense completion is enabled, note that the output timing of the print end signal (print done) differs between Backfeed After Print and Backfeed Before Print.
 - a. In Backfeed After Print, the print end signal (print done) is output after the label waiting for dispense is removed and the product backfeeds to the print start position.
 - b. In Backfeed Before Print, the print end signal (print done) is output after the product feeds the label to the dispense position.

2. "Printed 1 piece" includes the operation of the product feeding the label to the dispense position after printing.

Wireless LAN Interface

This interface complies with the IEEE802.11a/b/g/n/ac¹ standard.



- Before using wireless LAN near medical devices and facilities, consult your system administrator.

Basic Specifications	
Protocol	<ul style="list-style-type: none"> • STATUS3 • STATUS4 • STATUS5
IP Address	<ul style="list-style-type: none"> • IPv4 • IPv6
Subnet Mask / Prefix Length	<ul style="list-style-type: none"> • IPv4 • IPv6
Gateway Address	<ul style="list-style-type: none"> • IPv4 • IPv6
Data Transfer Method	<p>802.11a Max 54 Mbps</p> <p>802.11n Max 135 Mbps</p> <p>802.11b Max 11 Mbps</p> <p>802.11g Max 54 Mbps</p> <p>802.11ac¹ Max 390 Mbps</p> <hr/> <p> • These are the theoretical values based on the wireless LAN specifications and are not the actual data transfer speeds.</p> <hr/>
Frequency Band	<ul style="list-style-type: none"> • 2.4 GHz (2.412 to 2.472 GHz) • 5 GHz (5.180 to 5.825 GHz)
Communication Channel	The number of channels you can set varies depending on the region where you use the product.
SSID	Any alphanumeric character (Maximum 32)

Basic Specifications	
Authentication	<ul style="list-style-type: none"> • Open System • Shared Key • WPA/WPA2 • Perform the RADIUS server authentication using 802.1x (EAP-TLS, EAP-LEAP, EAP-TTLS, EAP-PEAP, EAP-FAST protocol)
Encryption	<ul style="list-style-type: none"> • None • WEP (64 bits/128 bits) • TKIP (WPA-PSK, WPA-802.1x) • AES (WPA2-PSK, WPA2-802.1x)
Communication Mode	<ul style="list-style-type: none"> • Infrastructure • Ad Hoc

¹ 802.11ac is supported on W-LAN2. The installed wireless module is displayed in [Wi-Fi Module] in the [Information] menu.

Software Specifications	
Supported Protocol	TCP/IP
Network Layer	<ul style="list-style-type: none"> • IP • ICMP
Session Layer	<ul style="list-style-type: none"> • TCP
Application Layer	<ul style="list-style-type: none"> • LPD • FTP • HTTP/HTTPS • SNMP • DHCP • NTP



• Specifications are subject to change without notice.

Built-in Functions

Item	CL4NX Plus	CL6NX Plus
Built-in Functions	<ul style="list-style-type: none"> • Status return • Graphic • Sequential number • Form overlay • Character modification • Black/white inversion • Ruled line • Dump list • Format registration • Outline font • Outline modification • Zero slash switching • Guidance video • LCD display in 31 languages • Cleaning notification • Calendar (Optional) • RFID (Optional : UHF, HF) • Barcode check (Optional) • Password lock • Logo, font download • LCD turns off • Standby • Total print count indication • Reprint • Power on in Online mode • Feed after error • Feed at power on • Command error indication • Non-standard mode • Priority settings 	<ul style="list-style-type: none"> • Status return • Graphic • Sequential number • Form overlay • Character modification • Black/white inversion • Ruled line • Dump list • Format registration • Outline font • Outline modification • Zero slash switching • Guidance video • LCD display in 31 languages • Cleaning notification • Calendar (Optional) • RFID (Optional : UHF) • Barcode check (Optional) • Password lock • Logo, font download • LCD turns off • Standby • Total print count indication • Reprint • Power on in Online mode • Feed after error • Feed at power on • Command error indication • Non-standard mode • Priority settings
Self-diagnosis Functions	<ul style="list-style-type: none"> • Broken head element check • Head open detection • Media size check • Paper end detection • Label near end detection 	

Item	CL4NX Plus	CL6NX Plus
	<ul style="list-style-type: none"> • Ribbon end detection • Ribbon near end detection • Test print • Cutter open check (If cutter unit is installed) • Label detection at dispensing (If dispenser unit is installed) 	
Adjustment Functions	<ul style="list-style-type: none"> • Print darkness • Print position • Media stop position • Buzzer • LCD brightness 	



• Specifications are subject to change without notice.

Printer Languages

- SBPL (Includes XML support)
- SZPL
- SDPL
- SIPL
- STCL
- SEPL

Standards

Item	Description
Environmental Standard	Compatible with the RoHS directive



- Specifications are subject to change without notice.
-

Usable Media



- Use our specified supply products.

Type

- Media roll (Face-in wound/face-out wound)
- Fan-fold media



- Some RFID tags may cause paper jams because the tags rise up during backfeed. Please check the performance of each RFID tag that you use. Be careful especially when you use the RFID tags that are less than 27 mm (1.06") long in cold environments.

Size

- Continuous

Item	CL4NX Plus	CL6NX Plus
Media Length	203 dpi 6 to 2497 mm (0.24" to 98.30") 305 dpi 6 to 1497 mm (0.24" to 58.94") 609 dpi 6 to 397 mm (0.24" to 15.63")	203 dpi 6 to 2497 mm (0.24" to 98.30") 305 dpi 6 to 1497 mm (0.24" to 58.94")
Media Length (With Liner)	203 dpi 9 to 2500 mm (0.35" to 98.42") 305 dpi 9 to 1500 mm (0.35" to 59.05") 609 dpi 9 to 400 mm (0.35" to 15.75")	203 dpi 9 to 2500 mm (0.35" to 98.42") 305 dpi 9 to 1500 mm (0.35" to 59.05")
Media Width	• 22 to 128 mm (0.87" to 5.04")	• 47 to 177 mm (1.85" to 6.97")
Media Width (With Liner)	• 25 to 131 mm (0.98" to 5.16")	• 50 to 180 mm (1.97" to 7.08")

*Above pitch and width are valid for die-cut labels. For media without liner, such as tags or non die-cut labels, use the 'with liner' values.

- Tear-Off/Cutter

Item	CL4NX Plus	CL6NX Plus
Media Length	203 dpi 17 to 2497 mm (0.67" to 98.30") 305 dpi 17 to 1497 mm (0.67" to 58.94") 609 dpi 17 to 397 mm (0.67" to 15.63")	203 dpi 17 to 2497 mm (0.67" to 98.30") 305 dpi 17 to 1497 mm (0.67" to 58.94")
Media Length (With Liner)	203 dpi 20 to 2500 mm (0.79" to 98.42") 305 dpi 20 to 1500 mm (0.79" to 59.05") 609 dpi 20 to 400 mm (0.79" to 15.75") When Print Mode is set to Cut & Print, the minimum media length for each print speed is the following value. 2 ips: 40 mm (1.57") 3 ips: 58 mm (2.28") 4 ips: 75 mm (2.95") 5 ips: 93 mm (3.66") 6 ips: 110 mm (4.33") 7 ips: 125 mm (4.92") 8 ips: 140 mm (5.51") 9 ips: 156 mm (6.14") 10 ips: 171 mm (6.73")	203 dpi 20 to 2500 mm (0.79" to 98.42") 305 dpi 20 to 1500 mm (0.79" to 59.05") When Print Mode is set to Cut & Print, the minimum media length for each print speed is the following value. 2 ips: 40 mm (1.57") 3 ips: 58 mm (2.28") 4 ips: 75 mm (2.95") 5 ips: 93 mm (3.66") 6 ips: 110 mm (4.33") 7 ips: 125 mm (4.92") 8 ips: 140 mm (5.51") 9 ips: 156 mm (6.14") 10 ips: 171 mm (6.73")
Media Width	<ul style="list-style-type: none"> 22 to 128 mm (0.87" to 5.04") 	<ul style="list-style-type: none"> 47 to 177 mm (1.85" to 6.97")
Media Width (With Liner)	<ul style="list-style-type: none"> 25 to 131 mm (0.98" to 5.16") 	<ul style="list-style-type: none"> 50 to 180 mm (1.97" to 7.08")

*Above pitch and width are valid for die-cut labels. For media without liner, such as tags or non die-cut labels, use the 'with liner' values.

- Cutter (When installing the rotary cutter unit)

Item	CL4NX Plus	CL6NX Plus
Media Length	203 dpi 30 to 2497 mm (1.18" to 98.30")	-

Item	CL4NX Plus	CL6NX Plus
	305 dpi 30 to 1497 mm (1.18" to 58.94") 609 dpi 30 to 397 mm (1.18" to 15.63")	
Media Length (With Liner)	203 dpi 33 to 2500 mm (1.30" to 98.42") 305 dpi 33 to 1500 mm (1.30" to 59.05") 609 dpi 33 to 400 mm (1.30" to 15.75")	-
Media Width	<ul style="list-style-type: none"> 22 to 128 mm (0.87" to 5.04") 	-
Media Width (With Liner)	<ul style="list-style-type: none"> 25 to 131 mm (0.98" to 5.16") 	-

*Above pitch and width are valid for die-cut labels. For media without liner, such as tags or non die-cut labels, use the 'with liner' values.

- Dispenser

Item	CL4NX Plus	CL6NX Plus
Media Length	<ul style="list-style-type: none"> 10 to 397 mm (0.39" to 15.63") * 10 to 27 mm are available only for thermal transfer. 	
Media Length (With Liner)	<ul style="list-style-type: none"> 13 to 400 mm (0.51" to 15.75") * 13 to 30 mm are available only for thermal transfer. 	
Media Width	<ul style="list-style-type: none"> 22 to 128 mm (0.87" to 5.04") 	<ul style="list-style-type: none"> 47 to 177 mm (1.85" to 6.97")
Media Width (With Liner)	<ul style="list-style-type: none"> 25 to 131 mm (0.98" to 5.16") 	<ul style="list-style-type: none"> 50 to 180 mm (1.97" to 7.08")
Diameter of Liner Winding	Maximum ϕ 120 mm (4.72")	

*Above pitch and width are valid for die-cut labels. For media without liner, such as tags or non die-cut labels, use the 'with liner' values.

- Linerless

Item	CL4NX Plus	CL6NX Plus
Media Length	30 to 120 mm (1.18" to 4.72")	-

Item	CL4NX Plus	CL6NX Plus
Media Width	60 to 118 mm (2.36" to 4.65")	-



- The length of RFID tag needs to be more than 15.8 mm (0.62").
- The usable media sizes and print quality depends conditions such as print speed, media, media/ribbon combination, product settings and used environment. It is highly recommended to check the performance based on actual usage conditions in advance.

Roll Diameter (Media Roll)

- (CL4NX Plus)
Maximum ϕ 265 mm (ϕ 10")



- This value is for when using the 3" core. If you use the 4" core, the maximum diameter is limited.

- (CL6NX Plus)
Maximum ϕ 220 mm (ϕ 8.66")
- When using a dispenser unit with liner rewinder
Maximum ϕ 220 mm (ϕ 8.66")

Core Diameter (Media Roll)

- ϕ 76 mm (ϕ 3"), ϕ 101 mm (ϕ 4")
- When using a dispenser unit with liner rewinder
 ϕ 76 mm (ϕ 3")



- It is recommended to use 4" core for thick paper (more than 150 μ m (0.0059")), non-adhesive media and RFID tags (RFID models only).

Height (Fan-fold Media)

- Maximum 200 mm (7.87")



- The maximum value is for when the product and media are placed on tables of the same height. The height may be limited depending on where media is placed.

Thickness

- 60 to 268 μ m (0.060 to 0.268 mm (0.0024" to 0.011"))





- The thickness of the thickest part of the RFID tag is more than 268 μ m (0.268 mm (0.011")). Be sure to do tests beforehand.

Usable Ribbon



- Use our specified supply products.

Item	CL4NX Plus	CL6NX Plus
Size	<p>Length</p> <p>Maximum 600 m (1968.5 feet)</p> <p>Maximum 300 m (984.3 feet) (in Micro Label Print Mode)</p> <p>Width</p> <p>39.5 to 128 mm (1.55" to 5.04")</p> <hr/> <p> <ul style="list-style-type: none"> • When the width of the ribbon is 39.5 mm (1.55"), the maximum length is 450 m (1476.4 feet). • The maximum length of the ribbon varies depending on the ribbon type. • Use the ribbon that is wider than the media. </p> <hr/>	<p>Length</p> <p>Maximum 600 m (1968.5 feet)</p> <p>Maximum 300 m (984.3 feet) (in Micro Label Print Mode)</p> <p>Width</p> <p>59 to 177 mm (2.32" to 6.97")</p> <hr/> <p> <ul style="list-style-type: none"> • The maximum length of the ribbon varies depending on the ribbon type. • Use the ribbon that is wider than the media. </p> <hr/>
Wind Direction	Both face-out/face-in	
Winding Method	Coreless	

Usable Fonts

Bitmap Fonts

Item	CL4NX Plus	CL6NX Plus
U	9 dots H x 5 dots W	
S	15 dots H x 8 dots W	
M	20 dots H x 13 dots W	
WB	30 dots H x 18 dots W	
WL	52 dots H x 28 dots W	
XU	9 dots H x 5 dots W	
XS	17 dots H x 17 dots W	
XM	24 dots H x 24 dots W	
XB	48 dots H x 48 dots W	
XL	48 dots H x 48 dots W	
X20	9 dots H x 5 dots W	
X21	17 dots H x 17 dots W	
X22	24 dots H x 24 dots W	
X23	48 dots H x 48 dots W	
X24	48 dots H x 48 dots W	
OCR-A	203 dpi 22 dots H x 15 dots W 305 dpi 33 dots H x 22 dots W 609 dpi 66 dots H x 44 dots W	203 dpi 22 dots H x 15 dots W 305 dpi 33 dots H x 22 dots W
OCR-B	203 dpi 24 dots H x 20 dots W 305 dpi 36 dots H x 30 dots W 609 dpi 72 dots H x 60 dots W	203 dpi 24 dots H x 20 dots W 305 dpi 36 dots H x 30 dots W

Item	CL4NX Plus	CL6NX Plus
JIS208 Kanji Fonts (Mincho/Gothic)	<ul style="list-style-type: none"> • 16 dots H x 16 dots W • 24 dots H x 24 dots W • 22 dots H x 22 dots W • 32 dots H x 32 dots W • 40 dots H x 40 dots W 	
JIS0213 Kanji Fonts (Gothic)	<ul style="list-style-type: none"> • 16 dots H x 16 dots W • 24 dots H x 24 dots W • 22 dots H x 22 dots W • 32 dots H x 32 dots W • 40 dots H x 40 dots W 	
Compatible Kanji Fonts (Mincho)	<ul style="list-style-type: none"> • 16 dots H x 16 dots W • 24 dots H x 24 dots W 	
Simplified Chinese Characters	<ul style="list-style-type: none"> • 16 dots H x 16 dots W • 24 dots H x 24 dots W 	
Traditional Chinese Characters	<ul style="list-style-type: none"> • 24 dots H x 24 dots W 	
Korean Fonts	<ul style="list-style-type: none"> • 16 dots H x 16 dots W • 24 dots H x 24 dots W 	

Scalable Fonts

Item	CL4NX Plus	CL6NX Plus
Rasterized Font	<ul style="list-style-type: none"> • SATO CG Sleek • SATO CG Stream • SATO 0 • SATO Alpha Bold Condensed • SATO Beta Bold Italic • SATO Folio Bold • SATO Futura Medium Condensed • SATO Gamma • SATO OCR-A • SATO OCR-B • SATO Sans • SATO Serif • SATO Symbol Set 	

Item	CL4NX Plus	CL6NX Plus
	<ul style="list-style-type: none"> • SATO WingBats 	
Rasterized Font (Multilingual)	<ul style="list-style-type: none"> • SATO Vica • SATO Hebe Sans • SATO Hebe Sans Arabic • SATO Hebe Sans Thai • SATO Hebe Sans Hebrew • SATO Hebe Sans Hindi • SATO Gothic Traditional Chinese • SATO Gothic Japanese • SATO Gothic Simplified Chinese • SATO Gothic Korean • SATO Silver Serif • SATO Mincho Traditional Chinese • SATO Mincho Japanese • SATO Mincho Simplified Chinese • SATO Mincho Korean • SATO Roman Arabic 	
Outline Fonts	<ul style="list-style-type: none"> • Helvetica Outline Font • JIS208 Kanji Outline Fonts 	



• Specifications are subject to change without notice.

X20 Font

The X20 font is a bitmap font with a basic size of 9 dots H x 5 dots W.

This supports the fixed pitch only.

A font sample is shown in the figure below.

	2	3	4	5	6	7	8	9	A	B	C	D	E	F
0		ø	ø	P		p				-	ヲ	ミ		
1	!	1	A	Q	a	q				ア	チ	ム		
2	"	2	B	R	b	r				イ	ツ	メ		
3	#	3	C	S	c	s				ウ	テ	モ		
4	\$	4	D	T	d	t				エ	ト	セ		
5	%	5	E	U	e	u			・	オ	ヲ	ユ		
6	&	6	F	V	f	v			ヨ	カ	ニ	ヨ		
7	'	7	G	W	g	w				キ	ヌ	ラ		
8	<	8	H	X	h	x				ク	ネ	リ		
9	>	9	I	Y	i	y				ケ	ノ	ル		
A	*	:	J	Z	j	z				コ	ハ	レ		
B	+	;	K	φ	k	-				サ	ヒ	ロ		
C	,	<	L	¥	l	-				シ	フ	ワ		
D	-	=	M		m					ス	ヘ	ン		
E	.	>	N		n	!				セ	ホ	〃		
F	/	?	O		o					ソ	マ	◇		

X21 Font

The X21 font is a bitmap font with a basic size of 17 dots H x 17 dots W.

You can select fixed pitch or proportional pitch.

A font sample is shown in the figure below.

	2	3	4	5	6	7	8	9	A	B	C	D	E	F
0	ø	@	P	'	p				一	タ	ミ			
1	!	1	A	Q	a	q			。	ア	チ	ム		
2	"	2	B	R	b	r			「	イ	ツ	メ		
3	#	3	C	S	c	s			」	ウ	テ	モ		
4	\$	4	D	T	d	t			、	エ	ト	ヤ		
5	%	5	E	U	e	u			・	オ	ナ	ユ		
6	&	6	F	V	f	v			ヲ	カ	ニ	ヨ		
7	'	7	G	W	g	w			ア	キ	ヌ	ラ		
8	(8	H	X	h	x			イ	ク	ネ	リ		
9)	9	I	Y	i	y			ウ	ケ	ノ	ル		
A	*	:	J	Z	j	z			エ	コ	ハ	レ		
B	+	;	K	[k	{			オ	サ	ヒ	ロ		
C	,	<	L	¥	l	;			ヤ	シ	フ	ワ		
D	-	=	M]	m	}			ユ	ス	ヘ	ソ		
E	.	>	N	^	n	~			ヨ	セ	ホ	°		
F	/	?	0	_	o				ツ	ソ	マ	°		



- To select proportional pitch, enable [SBPL] > [Font Settings] > [Proportional] in the [Applications] menu, or specify with the command.

X22 Font

The X22 font is a bitmap font with a basic size of 24 dots H x 24 dots W.

You can select fixed pitch or proportional pitch.

A font sample is shown in the figure below.

	2	3	4	5	6	7	8	9	A	B	C	D	E	F
0	0	@	P	`	p				一	夕	ミ			
1	!	1	A	Q	a	q			。	ア	チ	ム		
2	”	2	B	R	b	r			「	イ	ツ	メ		
3	#	3	C	S	c	s			」	ウ	テ	モ		
4	\$	4	D	T	d	t			、	エ	ト	ヤ		
5	%	5	E	U	e	u			-	オ	ナ	ユ		
6	&	6	F	V	f	v			ヲ	カ	ニ	ヨ		
7	'	7	G	W	g	w			ア	キ	ヌ	ラ		
8	(8	H	X	h	x			イ	ク	ネ	リ		
9)	9	I	Y	i	y			ウ	ケ	ノ	ル		
A	*	:	J	Z	j	z			エ	コ	ハ	レ		
B	+	;	K	[k	{			オ	サ	ヒ	ロ		
C	,	<	L	¥	!	!			ヤ	シ	フ	ワ		
D	-	=	M]	m	}			ユ	ス	ヘ	ン		
E	.	>	N	^	n	~			ヨ	セ	ホ	°		
F	/	?	O	_	o				ツ	ソ	マ	°		



- To select proportional pitch, enable [SBPL] > [Font Settings] > [Proportional] in the [Applications] menu, or specify with the command.

X23 Font

The X23 font is a bitmap font with a basic size of 48 dots H x 48 dots W.

You can select fixed pitch or proportional pitch.

A font sample is shown in the figure below.

	2	3	4	5	6	7	8	9	A	B	C	D	E	F
0	0	@	P	`	p				一	タ	ミ			
1	!	1	A	Q	a	q			。	ア	チ	ム		
2	"	2	B	R	b	r			「	イ	ツ	メ		
3	#	3	C	S	c	s			」	ウ	テ	モ		
4	\$	4	D	T	d	t			、	エ	ト	ヤ		
5	%	5	E	U	e	u			・	オ	ナ	ユ		
6	&	6	F	V	f	v			ヲ	カ	ニ	ヨ		
7	'	7	G	W	g	w			ア	キ	ヌ	ラ		
8	(8	H	X	h	x			イ	ク	ネ	リ		
9)	9	I	Y	i	y			ウ	ケ	ノ	ル		
A	*	:	J	Z	j	z			エ	コ	ハ	レ		
B	+	;	K	[k	{			オ	サ	ヒ	ロ		
C	,	<	L	¥	!	!			ヤ	シ	フ	ワ		
D	-	=	M]	m	}			ユ	ス	ヘ	ン		
E	.	>	N	^	n	~			ヨ	セ	ホ	°		
F	/	?	O	_	o				ツ	ソ	マ	°		



- To select proportional pitch, enable [SBPL] > [Font Settings] > [Proportional] in the [Applications] menu, or specify with the command.

X24 Font

The X24 font is a bitmap font with a basic size of 48 dots H x 48 dots W.

You can select fixed pitch or proportional pitch.

A font sample is shown in the figure below.

	2	3	4	5	6	7	8	9	A	B	C	D	E	F
0	0	@	P	'	p				一	タ	ミ			
1	!	1	A	Q	a	q			。	ア	チ	ム		
2	"	2	B	R	b	r			「	イ	ツ	メ		
3	#	3	C	S	c	s			」	ウ	テ	モ		
4	\$	4	D	T	d	t			、	エ	ト	ヤ		
5	%	5	E	U	e	u			・	オ	ナ	ユ		
6	&	6	F	V	f	v			ヲ	カ	ニ	ヨ		
7	'	7	G	W	g	w			ア	キ	ヌ	ラ		
8	(8	H	X	h	x			イ	ク	ネ	リ		
9)	9	I	Y	i	y			ウ	ケ	ノ	ル		
A	*	:	J	Z	j	z			エ	コ	ハ	レ		
B	+	;	K	[k	{			オ	サ	ヒ	ロ		
C	,	<	L	¥	l	!			ヤ	シ	フ	フ		
D	-	=	M]	m	}			ユ	ス	ヘ	ン		
E	.	>	N	^	n	~			ヨ	セ	ホ	°		
F	/	?	O	_	o				ツ	ソ	マ	°		



- To select proportional pitch, enable [SBPL] > [Font Settings] > [Proportional] in the [Applications] menu, or specify with the command.

U Font

The U font is a bitmap font with a basic size of 9 dots H x 5 dots W.

This supports the fixed pitch only.

The figure below is a font sample when the code page 858 is used.

	2	3	4	5	6	7	8	9	A	B	C	D	E	F
0	ø	ø	ø	ø	ø	ø	ø	ø	ø	ø	ø	ø	ø	-
1	!	1	À	Q	a	q	ü	æ	í			Ð	β	±
2	"	2	B	R	b	r	é	Æ	ó			é	ó	=
3	#	3	C	S	c	s	á	ô	ú			ë	ò	¼
4	\$	4	D	T	d	t	ä	ö	ñ			è	ø	¶
5	%	5	E	U	e	u	à	ò	ñ	á		€	ø	§
6	&	6	F	V	f	v	á	û	æ	á	ã	í	µ	÷
7	'	7	G	W	g	w	ç	ù	ø	à	ã	î	þ	,
8	<	8	H	X	h	x	é	ÿ	ú	ø		ï	þ	°
9	>	9	I	Y	i	y	ë	ö	«			ó		¨
A	*	:	J	Z	j	z	è	ü	¬			ó		+
B	+	;	K	[k	{	ï	ø	¼			ù		!
C	,	<	L	\	l		î	£	¼			ý		³
D	-	=	M]	m	}	ì	§	;	¢		ì	ý	²
E	.	>	N	^	n	~	ñ	x	«	¥		ì	~	
F	/	?	O	_	o		á	f	»				'	



- The character set is changed according to the [SBPL] > [Font Settings] > [Code Page] settings in the [Applications] menu or the code page specified using commands.

S Font

The S font is a bitmap font with a basic size of 15 dots H x 8 dots W.

This supports the fixed pitch only.

The figure below is a font sample when the code page 858 is used.

	2	3	4	5	6	7	8	9	A	B	C	D	E	F
0	ø	ø	ø	P	'	p	ç	é	á	ø		ø	ó	-
1	!	1	A	Q	a	q	ü	æ	í			Ð	β	±
2	"	2	B	R	b	r	é	Æ	ó			Ê	ô	=
3	#	3	C	S	c	s	â	ô	ú			Ë	ò	¾
4	\$	4	D	T	d	t	ä	ö	ñ			È	õ	¶
5	%	5	E	U	e	u	à	ò	Ñ	Á		€	õ	§
6	&	6	F	V	f	v	à	û	â	Â	ã	í	μ	÷
7	'	7	G	W	g	w	ç	ù	º	À	Ã	î	þ	,
8	(8	H	X	h	x	ê	ÿ	¿	©		ï	þ	°
9)	9	I	Y	i	y	ë	ö	®			ú	¨	
A	*	:	J	Z	j	z	è	ü	™			û	•	
B	+	;	K	[k	{	ï	ø	½			ù	¡	
C	,	<	L	\	l	!	î	£	¼			ý	³	
D	-	=	M]	m	}	ì	ø	¡	¢		ì	ý	²
E	.	>	N	^	n	~	Ä	×	«	¥		ì	´	
F	/	?	O	_	o	■	Á	f	»		◊		´	



- The character set is changed according to the [SBPL] > [Font Settings] > [Code Page] settings in the [Applications] menu or the code page specified using commands.

M Font

The M font is a bitmap font with a basic size of 20 dots H x 13 dots W.

This supports the fixed pitch only.

The figure below is a font sample when the code page 858 is used.

	2	3	4	5	6	7	8	9	A	B	C	D	E	F
0	ø	@	P	'	p	ç	é	á	ø		ö	ó	-	
1	!	1	A	Q	a	q	ü	æ	í			Ð	β	±
2	”	2	B	R	b	r	é	Æ	ó			Ê	Ô	=
3	#	3	C	S	c	s	â	ô	ú			Ë	Ò	¼
4	\$	4	D	T	d	t	ä	ö	ñ			È	Õ	¶
5	%	5	E	U	e	u	à	ò	Ñ	Á		€	Ø	§
6	&	6	F	V	f	v	å	û	æ	Â	ã	í	μ	÷
7	'	7	G	W	g	w	ç	ù	ø	À	Ã	î	þ	,
8	(8	H	X	h	x	ê	ÿ	ı	©		ÿ	þ	°
9)	9	I	Y	i	y	ë	ö	®				Ú	¨
A	*	:	J	Z	j	z	è	ü	¬				Û	•
B	+	;	K	[k	{	ï	ø	½				Ü	¡
C	,	<	L	\	l	!	î	£	¼				Ý	³
D	-	=	M]	m	}	ì	Ø	ı	¢		ı	Ý	²
E	.	>	N	^	n	~	Ä	X	«	¥		ì	-	
F	/	?	O	_	o	■	Å	f	»		⊗		'	



- The character set is changed according to the [SBPL] > [Font Settings] > [Code Page] settings in the [Applications] menu or the code page specified using commands.

WB Font

The WB font is a bitmap font with a basic size of 30 dots H x 18 dots W.

This supports the fixed pitch only.

The figure below is a font sample when the code page 858 is used.

	2	3	4	5	6	7	8	9	A	B	C	D	E	F
0	ø	@	P	'	p	Ç	É	á	ø			ð	ó	-
1	!	1	A	Q	a	q	ü	æ	í			Ð	β	±
2	"	2	B	R	b	r	é	Æ	ó			Ê	ô	=
3	#	3	C	S	c	s	â	ô	ú			Ë	ò	¼
4	\$	4	D	T	d	t	ä	ö	ñ			È	õ	¶
5	%	5	E	U	e	u	à	ò	Ñ	Á		€	ö	§
6	&	6	F	V	f	v	â	û	ä	Â	ã	í	μ	÷
7	'	7	G	W	g	w	ç	ù	ó	À	Ã	î	þ	,
8	(8	H	X	h	x	ê	ÿ	¿	©		ï	þ	°
9)	9	I	Y	i	y	ë	ö	®			ú	¨	
A	*	:	J	Z	j	z	è	Ü	¬			û	•	
B	+	;	K	[k	{	ï	ø	½			ù	¡	
C	,	<	L	\	l		î	£	¼			ý	³	
D	-	=	M]	m	}	ì	Ø	ì	ø		ı	ý	²
E	.	>	N	^	n	~	Ä	x	«	¥		ì	-	
F	/	?	O	_	o	■	Á	f	»		α		'	



- The character set is changed according to the [SBPL] > [Font Settings] > [Code Page] settings in the [Applications] menu or the code page specified using commands.

WL Font

The WL font is a bitmap font with a basic size of 52 dots H x 28 dots W.

This supports the fixed pitch only.

The figure below is a font sample when the code page 858 is used.

	2	3	4	5	6	7	8	9	A	B	C	D	E	F
0	ø	@	P	'	p	Ç	É	á	Ø		ø	ó	-	
1	!	1	A	Q	a	q	ü	æ	í			Ð	β	±
2	"	2	B	R	b	r	é	Æ	ó			Ê	Ô	≡
3	#	3	C	S	c	s	â	ô	ú			È	Ò	¾
4	\$	4	D	T	d	t	ä	ö	ñ			È	õ	π
5	%	5	E	U	e	u	à	ò	Ñ	Á		€	Õ	§
6	&	6	F	V	f	v	å	û	ª	Â	ã	Í	μ	÷
7	'	7	G	W	g	w	ç	ù	º	À	Ã	Î	þ	,
8	(8	H	X	h	x	ê	ÿ	¿	©		ï	þ	°
9)	9	I	Y	i	y	ë	ö	®				Ú	¨
A	*	:	J	Z	j	z	è	Ü	¬				Û	•
B	+	;	K	[k	{	ï	ø	½				Ü	¹
C	,	<	L	\	l		î	£	¼				Ý	³
D	-	=	M]	m	}	ì	Ø	¡	¢		!	Ý	²
E	.	>	N	^	n	~	Ä	x	«	¥		ì	˘	
F	/	?	O	_	o	■	Å	f	»		α		˘	



- The character set is changed according to the [SBPL] > [Font Settings] > [Code Page] settings in the [Applications] menu or the code page specified using commands.

XU Font

The XU font is a bitmap font with a basic size of 9 dots H x 5 dots W.

You can select fixed pitch or proportional pitch.

The figure below is a font sample when the code page 858 is used.

	2	3	4	5	6	7	8	9	A	B	C	D	E	F
0		ø	ø	P	`	p	ç	é	á	ø		ø	ó	-
1	!	1	À	Q	a	q	ü	æ	í			Ð	β	±
2	"	2	B	R	b	r	é	Æ	ó			é	ó	=
3	#	3	C	S	c	s	á	ó	ú			ë	ò	¼
4	\$	4	D	T	d	t	ä	ö	ñ			è	ø	¶
5	%	5	E	U	e	u	à	ò	ñ	á		€	ø	§
6	&	6	F	V	f	v	á	ú	æ	á	ä	í	µ	÷
7	'	7	G	W	g	w	ç	ù	ó	à	ã	î	þ	,
8	<	8	H	X	h	x	é	ý	ú	ø		ï	þ	°
9	>	9	I	Y	i	y	ë	ö	«				ó	~
A	*	:	J	Z	j	z	è	ü	¬				ó	+
B	+	;	K	I	k	{	ï	ø	¼				ù	!
C	,	<	L	\	l		î	£	¼				ý	»
D	-	=	M	I	m	}	ì	ø	;	¢		!	ý	²
E	.	>	N	^	n	~	ñ	x	«	¥		ì	~	
F	/	?	O	_	o		á	f	»		»		'	



- To select proportional pitch, enable [SBPL] > [Font Settings] > [Proportional] in the [Applications] menu, or specify with the command.
- The character set is changed according to the [SBPL] > [Font Settings] > [Code Page] settings in the [Applications] menu or the code page specified using commands.

XS Font

The XS font is a bitmap font with a basic size of 17 dots H x 17 dots W.

You can select fixed pitch or proportional pitch.

The figure below is a font sample when the code page 858 is used.

	2	3	4	5	6	7	8	9	A	B	C	D	E	F
0	ø	@	P	'	p	ç	É	á	ø		đ	ó	-	
1	!	1	A	Q	a	q	ü	æ	í			Ð	ß	±
2	"	2	B	R	b	r	é	Æ	ó			È	Ò	=
3	#	3	C	S	c	s	â	ô	ú			É	Ó	¾
4	\$	4	D	T	d	t	ä	ö	ñ			È	õ	¶
5	%	5	E	U	e	u	à	ò	Ñ	À		€	Ö	§
6	&	6	F	V	f	v	â	û	ä	Â	ã	í	µ	÷
7	'	7	G	W	g	w	ç	ù	ó	À	Á	í	þ	,
8	(8	H	X	h	x	ê	ÿ	¿	©		ÿ	þ	°
9)	9	I	Y	i	y	ë	ö	®			Ü	¨	
A	*	:	J	Z	j	z	è	Ü	¬			Ü	•	
B	+	;	K	[k	{	ï	ø	½			Ü	¹	
C	,	<	L	\	l	;	î	£	¼			ý	³	
D	-	=	M]	m	}	ì	ø	ì	ø		;	ÿ	²
E	.	>	N	^	n	~	Ä	x	«	¥		l	´	
F	/	?	O	_	o	■	Å	f	»		α		´	



- To select proportional pitch, enable [SBPL] > [Font Settings] > [Proportional] in the [Applications] menu, or specify with the command.
- The character set is changed according to the [SBPL] > [Font Settings] > [Code Page] settings in the [Applications] menu or the code page specified using commands.

XM Font

The XM font is a bitmap font with a basic size of 24 dots H x 24 dots W.

You can select fixed pitch or proportional pitch.

The figure below is a font sample when the code page 858 is used.

	2	3	4	5	6	7	8	9	A	B	C	D	E	F
0	0	@	P	`	p	Ç	É	á	Ø		đ	Ó	-	
1	!	1	A	Q	a	q	ü	æ	í			Ð	β	±
2	”	2	B	R	b	r	é	Æ	ó			Ê	Ô	=
3	#	3	C	S	c	s	â	ô	ú			Ë	Ò	¾
4	\$	4	D	T	d	t	ä	ö	ñ			È	õ	¶
5	%	5	E	U	e	u	à	ò	Ñ	Á		€	Õ	§
6	&	6	F	V	f	v	ã	û	ä	Â	ã	Í	μ	÷
7	'	7	G	W	g	w	ç	ù	º	À	Ã	î	þ	,
8	(8	H	X	h	x	ê	ÿ	¿	©		ï	þ	°
9)	9	I	Y	i	y	ë	Ö	®			Ú	”	
A	*	:	J	Z	j	z	è	Ü	¬			Û	•	
B	+	;	K	[k	{	ï	ø	½			Ü	¹	
C	,	<	L	\	l	;	î	£	¼			Ý	³	
D	-	=	M]	m	}	ì	Ø	ï	¢		ÿ	²	
E	.	>	N	^	n	~	Ä	x	<<	¥		ÿ	´	
F	/	?	O	_	o	■	Å	f	>>		α	´		



- To select proportional pitch, enable [SBPL] > [Font Settings] > [Proportional] in the [Applications] menu, or specify with the command.
- The character set is changed according to the [SBPL] > [Font Settings] > [Code Page] settings in the [Applications] menu or the code page specified using commands.

XB Font

The XB font is a bitmap font with a basic size of 48 dots H x 48 dots W.

You can select fixed pitch or proportional pitch.

The figure below is a font sample when the code page 858 is used.

	2	3	4	5	6	7	8	9	A	B	C	D	E	F
0	0	@	P	`	p	Ç	É	á	Ø			Š	Ó	-
1	!	1	A	Q	a	q	ü	æ	í			Ð	β	±
2	"	2	B	R	b	r	é	Æ	ó			Ê	Ô	=
3	#	3	C	S	c	s	â	ô	ú			Ë	Ò	¾
4	\$	4	D	T	d	t	ä	ö	ñ			È	õ	¶
5	%	5	E	U	e	u	à	ò	Ñ	Á		€	Õ	§
6	&	6	F	V	f	v	â	û	ä	Â	ã	Í	μ	÷
7	'	7	G	W	g	w	ç	ù	ó	À	Ã	İ	þ	,
8	(8	H	X	h	x	ê	ÿ	¿	©		ï	þ	°
9)	9	I	Y	i	y	ë	ö	®			Ú	..	
A	*	:	J	Z	j	z	è	Ü	¬			Û	•	
B	+	;	K	[k	{	ï	ø	½			Ü	¹	
C	,	<	L	\	l	!	î	£	¼			Ý	³	
D	-	=	M]	m	}	ï	ø	¡	¢		ÿ	²	
E	.	>	N	^	n	~	Ä	×	«	¥		ı	-	
F	/	?	O	_	o	■	Å	f	»		α	´		



- To select proportional pitch, enable [SBPL] > [Font Settings] > [Proportional] in the [Applications] menu, or specify with the command.
- The character set is changed according to the [SBPL] > [Font Settings] > [Code Page] settings in the [Applications] menu or the code page specified using commands.

XL Font

The XL font is a bitmap font with a basic size of 48 dots H x 48 dots W.

You can select fixed pitch or proportional pitch.

The figure below is a font sample when the code page 858 is used.

	2	3	4	5	6	7	8	9	A	B	C	D	E	F
0	0	@	P	'	p	Ç	É	á	Ø			ð	Ó	-
1	!	1	A	Q	a	q	ü	æ	í			Ð	β	±
2	"	2	B	R	b	r	é	Æ	ó			Ê	Ô	=
3	#	3	C	S	c	s	â	ô	ú			Ë	Ò	¾
4	\$	4	D	T	d	t	ä	ö	ñ			È	õ	¶
5	%	5	E	U	e	u	à	ò	Ñ	Á		€	Õ	§
6	&	6	F	V	f	v	â	û	ª	Â	ã	Í	μ	÷
7	'	7	G	W	g	w	ç	ù	º	À	Ã	Î	þ	,
8	(8	H	X	h	x	ê	ÿ	¿	©		Ï	ƒ	°
9)	9	I	Y	i	y	ë	Ö	®			¼	Ú	••
A	*	:	J	Z	j	z	è	Ü	¬			½	Û	•
B	+	;	K	[k	{	ï	ø	½			¾	Ü	¹
C	,	<	L	\	l		î	£	¼			¾	Ý	³
D	-	=	M]	m	}	ì	Ø	ì	¢		¾	Ý	²
E	.	>	N	^	n	~	Ä	x	«	¥		¾	Ý	
F	/	?	O	_	o	■	Å	f	»		α	¾	Ý	



- To select proportional pitch, enable [SBPL] > [Font Settings] > [Proportional] in the [Applications] menu, or specify with the command.
- The character set is changed according to the [SBPL] > [Font Settings] > [Code Page] settings in the [Applications] menu or the code page specified using commands.

OCR-A Font

The OCR-A font is a bitmap font. The basic size varies depending on the print resolutions as follows:

Print Resolution	Basic Font Size	
	CL4NX Plus	CL6NX Plus
203 dpi (8 dots/mm)	22 dots H x 15 dots W	22 dots H x 15 dots W
305 dpi (12 dots/mm)	33 dots H x 22 dots W	33 dots H x 22 dots W
609 dpi (24 dots/mm)	66 dots H x 44 dots W	-

This supports the fixed pitch only.

The figure below is a font sample when the print resolution is 203 dpi (8 dots/mm).

	2	3	4	5	6	7	8	9	A	B	C	D	E	F
0		0		P										
1		1	A	Q										
2		2	B	R										
3		3	C	S										
4	\$	4	D	T										
5		5	E	U										
6		6	F	V										
7		7	G	W										
8		8	H	X										
9		9	I	Y										
A			J	Z										
B			K											
C			L											
D			M											
E	.	>	N											
F	/		0											

OCR-B Font

The OCR-B font is a bitmap font. The basic size varies depending on the print resolutions as follows:

Print Resolution	Basic Font Size	
	CL4NX Plus	CL6NX Plus
203 dpi (8 dots/mm)	24 dots H x 20 dots W	24 dots H x 20 dots W
305 dpi (12 dots/mm)	36 dots H x 30 dots W	36 dots H x 30 dots W
609 dpi (24 dots/mm)	72 dots H x 60 dots W	-

This supports the fixed pitch only.

The figure below is a font sample when the print resolution is 203 dpi (8 dots/mm).

	2	3	4	5	6	7	8	9	A	B	C	D	E	F
0		0	@	P										
1	!	1	A	Q										
2	"	2	B	R										
3	#	3	C	S										
4	\$	4	D	T										
5	%	5	E	U										
6	&	6	F	V										
7	'	7	G	W										
8	(8	H	X										
9)	9	I	Y										
A	*	:	J	Z										
B	+	;	K	¥										
C	,	<	L	¥										
D	-	=	M											
E	.	>	N											
F	/	?	O											

Outline Fonts

The font type, font size and font shape can be specified for the outline fonts.

For the font type, you can select fixed pitch or proportional pitch. You can also specify kanji, but kanji supports fixed pitch only.

The figure below is a sample of some font shapes. Shapes such as normal font, white characters on black background, grey font, font with shadow, mirrored font and italic font can be specified.

This is a sample of Outline font.

Outline font0 ABCabc123
Outline font1 ABCabc123
Outline font2 ABCabc123
Outline font3 ABCabc123
Outline font4 ABCabc123
Outline font5 ABCabc123
Outline font6 ABCabc123
Outline font7 ABCabc123
Outline font8 ABCabc123
Outline font9 ABCabc123

The figure below is a font sample with the standard font.

	2	3	4	5	6	7	8	9	A	B	C	D	E	F
0		0	@	P	'	p				ー	タ	ミ		
1	!	1	A	Q	a	q			。	ア	チ	ム		
2	"	2	B	R	b	r			「	イ	ツ	メ		
3	#	3	C	S	c	s			」	ウ	テ	モ		
4	\$	4	D	T	d	t			、	エ	ト	ヤ		
5	%	5	E	U	e	u			・	オ	ナ	ユ		
6	&	6	F	V	f	v			ヲ	カ	ニ	ヨ		
7	´	7	G	W	g	w			ァ	キ	ヌ	ラ		
8	(8	H	X	h	x			ィ	ク	ネ	リ		
9)	9	I	Y	i	y			ゥ	ケ	ノ	ル		
A	*	:	J	Z	j	z			ェ	コ	ハ	レ		
B	+	;	K	[k	{			ォ	サ	ヒ	ロ		
C	,	<	L	¥	l	!			ャ	シ	フ	ワ		
D	-	=	M]	m	}			ュ	ス	ヘ	ン		
E	.	>	N	^	n	~			ョ	セ	ホ	°		
F	/	?	O	_	o				ッ	ソ	マ	°		



- The font size can be specified from 1 to 999 dots, but if the font size is too small for the font shape, it cannot be recognized as a font. Please be careful. Also, if the specified font size is too small, it may collapse, depending on the font.

Multilingual Font

The product contains various multilingual fonts.

The figure below is a sample of some of the multilingual fonts.

b	Fontname	Sample
0	SATO Hebe Sans	This is a fontsample.
8	SATO Silver Serif	This is a fontsample.
1	SATO Hebe Sans Arabic	هذا هو عينة من الخط.
13	SATO Roman Arabic	هذا هو عينة من الخط.
2	SATO Hebe Sans Thai	นี่คือตัวอย่างของตัวอักษร
3	SATO Hebe Sans Hindi	इस फॉन्ट का एक नमूना है.
14	SATO Hebe Sans Hebrew	דוגמה של מונחית פונט
4	SATO Gothic Tradional Chinese	這是字體的樣本。
9	SATO Mincho Tradional Chinese	這是字體的樣本。
6	SATO Gothic Simplified Chinese	这是字体的样本。
11	SATO Mincho Simplified Chinese	这是字体的样本。
5	SATO Gothic Japanese	これはフォントのサンプルです。
10	SATO Mincho Japanese	これはフォントのサンプルです。
7	SATO Gothic Korean	이것은 글꼴의 샘플입니다.
12	SATO Mincho Korean	이것은 글꼴의 샘플입니다.

Scalable Fonts

The product contains various scalable fonts.

The figure below is a sample of some scalable fonts.

Fontname	Sample
SATOCGSleek.ttf	ABCXYZabcdefghijklmnopqrstuvwxyz123
SATOCGStream.ttf	ABCXYZabcdefghijklmnopqrstuvwxyz123
SAT00CRA.ttf	A B C X Y Z a b c x y z 1 2 3
SAT008.ttf	ABCXYZabcdefghijklmnopqrstuvwxyz123
SAT0ALPHABC.ttf	ABCXYZabcdefghijklmnopqrstuvwxyz123
SAT0BETABI.ttf	<i>ABCXYZabcdefghijklmnopqrstuvwxyz123</i>
SAT0FOLI0B.ttf	ABCXYZabcdefghijklmnopqrstuvwxyz123
SAT0FUTURAMC.ttf	ABCXYZabcdefghijklmnopqrstuvwxyz123
SAT0GAMMA.ttf	ABCXYZabcdefghijklmnopqrstuvwxyz123
SAT00CRB.ttf	A B C X Y Z a b c x y z 1 2 3
SAT0SANS.ttf	ABCXYZabcdefghijklmnopqrstuvwxyz123
SAT0SERIF.ttf	ABCXYZabcdefghijklmnopqrstuvwxyz123
SAT0SYM.ttf	f/... √∞-HΘIηθι678
SAT0VICA.ttf	ABCXYZabcdefghijklmnopqrstuvwxyz123
SAT0WING.ttf	☺☻☼☽☾☿♁♂♃♄♅♆♇♈♉♊♋♌♍♎♏♐♑♒♓♔♕♖♗♘♙♚♛♜♝♞♟♠♡♢♣♤♥♦♧♨♩♪♫♬♭♮♯♰♱♲♳♴♵♶♷♸♹♺♻♼♽♾♿

Usable Barcodes

Code Type	CL4NX Plus	CL6NX Plus
Barcodes	<ul style="list-style-type: none"> • UPC-A/UPC-E • JAN/EAN-13/8 • CODE39, CODE93, CODE128 • GS1-128(UCC/EAN128) • CODABAR(NW-7) • ITF • Industrial 2 of 5 • Matrix 2 of 5 • MSI • POSTNET • UPC add-on code • BOOKLAND • USPS code • GS1 DataBar Omnidirectional • GS1 DataBar Truncated • GS1 DataBar Stacked • GS1 DataBar Stacked Omnidirectional • GS1 DataBar Limited • GS1 DataBar Expanded • GS1 DataBar Expanded Stacked 	
2D Codes	<ul style="list-style-type: none"> • QR Code • Micro QR Code • PDF417 • Micro PDF • Maxi Code • GS1 Data Matrix • Data Matrix (ECC200) • Aztec Code • GS1QR Code 	
Composite Symbols	<ul style="list-style-type: none"> • EAN-13 Composite (CC-A/CC-B) • EAN-8 Composite (CC-A/CC-B) • UPC-A Composite (CC-A/CC-B) • UPC-E Composite (CC-A/CC-B) • GS1 DataBar Composite (CC-A/CC-B) 	

Code Type	CL4NX Plus	CL6NX Plus
	<ul style="list-style-type: none">• GS1 DataBar Truncated Composite (CC-A/CC-B)• GS1 DataBar Stacked Composite (CC-A/CC-B)• GS1 DataBar Expanded Stacked Composite (CC-A/CC-B)• GS1 DataBar Expanded Composite (CC-A/CC-B)• GS1 DataBar Stacked Omnidirectional Composite (CC-A/CC-B)• GS1 DataBar Limited Composite (CC-A/CC-B)• GS1-128 Composite (CC-A/CC-B/CC-C)	



- Specifications are subject to change without notice.
-

Support and Warranty

SOS (SATO Online Services) (SOS users only)

The SOS (SATO Online Services) is a remote maintenance service that monitors your product status for 24 hours and supports its stable operation. To use this service, create an SOS account and add your product.



For details on the SOS, refer to the SOS Portal Site.

 <https://www.sato-sos.com/en/>

Warranty for Consumables within the Product Warranty Period

For information on the warranty period for print heads, platen rollers, cutters and rotary cutters, refer to the SATO Global Warranty Program.

 <https://www.sato-global.com/warranty/>

